

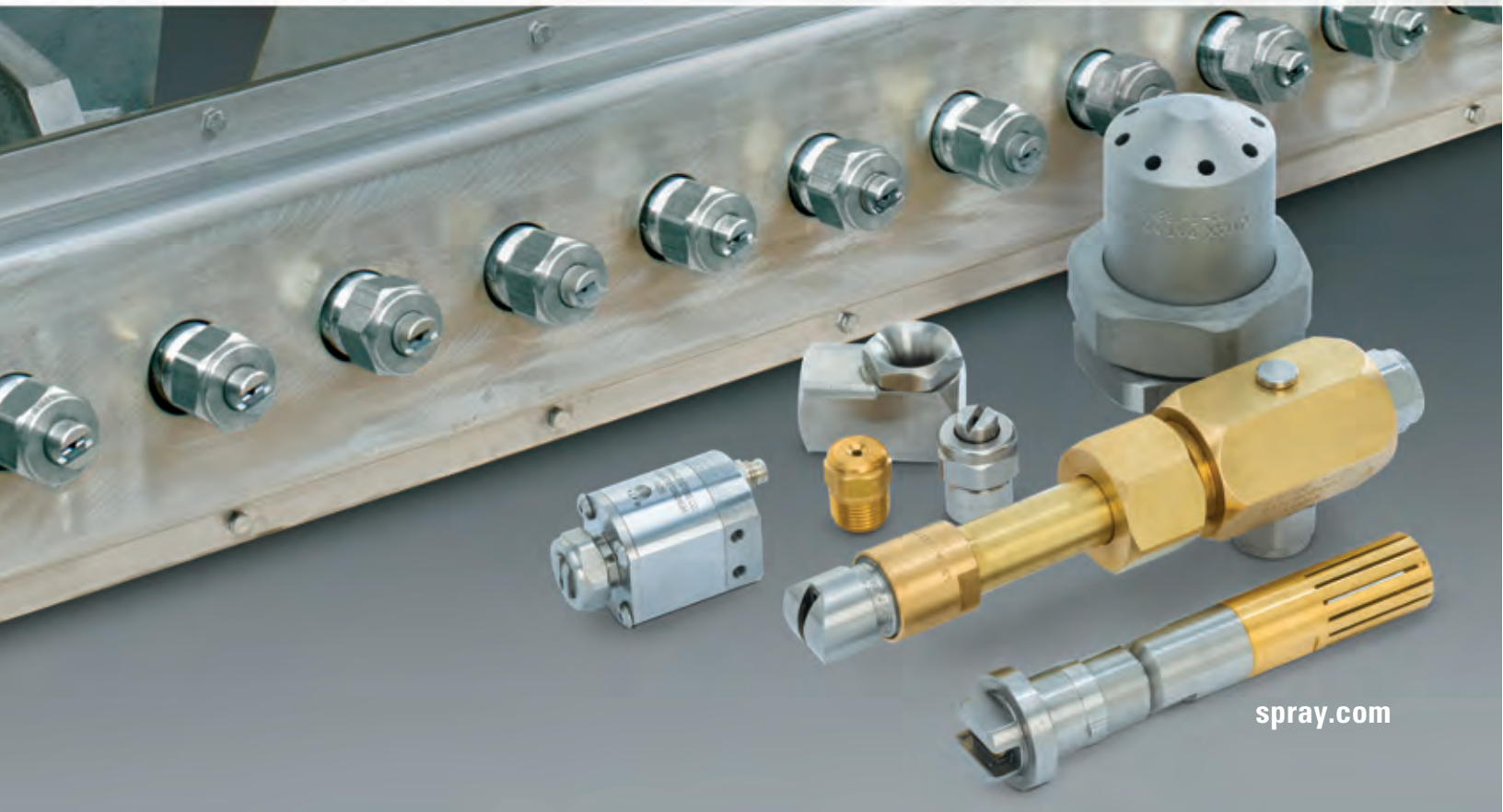

Spraying Systems Co.
Experts in Spray Technology

SPRAY TECHNOLOGY FOR STEEL MILLS





THANK YOU FOR YOUR INTEREST IN OUR SPRAY PRODUCTS FOR STEEL MILLS.

We look forward to helping you optimize your operations involving spray technology. We're uniquely qualified to assist:

Many of our nozzles, headers and systems are specially-designed for use in steel mills. Our products are optimized for impact, heat transfer, cooling efficiency, pressure, coverage, water conservation, quick maintenance and more. We have the most comprehensive line of spray products available but we are always willing to make nozzles in different materials and sizes to ensure you get the performance you need. Spray headers and lances are built-to-order; again to optimize performance in your operation.

















Our offering goes beyond nozzles, lances and systems. We provide a wide range of testing and modeling services to ensure the desired performance is achieved in critical applications. By simulating your operating conditions in our spray laboratories or with Computational Fluid Dynamics (CFD) modeling, we can determine which nozzles, header layouts and lance designs will be most effective and meet your operational objectives.

Our spray expertise is unmatched. Our sole focus has been on spray technology for more than 75 years. Engineering and technical support are provided to mills around the world from our ten manufacturing facilities and more than 90 sales offices. No-cost optimization, inspection, maintenance and other educational programs are readily available as well.

Let us show you why mills around the world rely on us to help boost production, improve steel quality, lower operating costs, minimize waste and more. Just give us a call or visit spray.com to learn more.



TABLE OF CONTENTS

	Introduction	1	
	Fabrication and Testing	A1	
	Solutions for Continuous Casting	B1	
	Solutions for Hot Rolling Mills	C1	
	Solutions for Cold Rolling Mills	D1	
	Solutions for Iron and Steelmaking	E1	
	Technical Reference	F1	
	Performance Data	G1	

SOLUTIONS FOR STEEL APPLICATIONS



SECTION B CONTINUOUS CASTING

- CasterJet® nozzles
- FlatJet® nozzles
- FloodJet® nozzles
- FullJet® nozzles
- VeeJet® nozzles

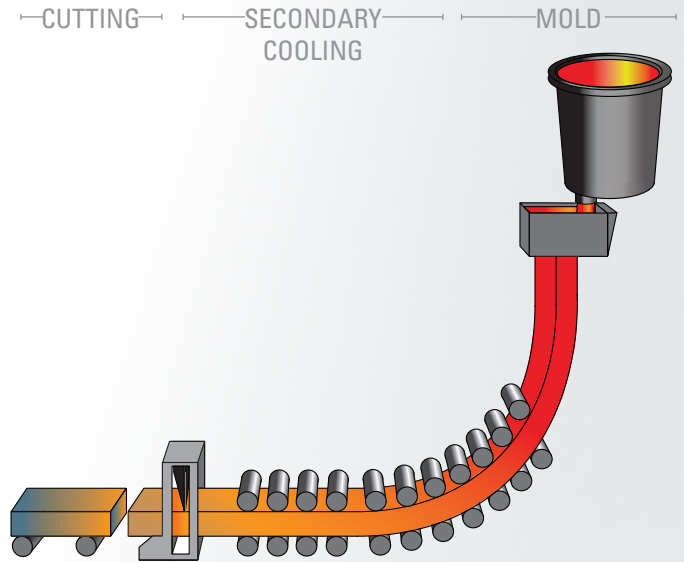

SECTION D COLD ROLLING MILLS

- FlatJet nozzles
- FloodJet nozzles
- FullJet nozzles
- PulsaJet® nozzles
- PVDF VeeJet nozzles and headers
- VeeJet nozzles and headers
- WindJet® nozzles
- Air headers
- Automatic and air atomizing nozzles

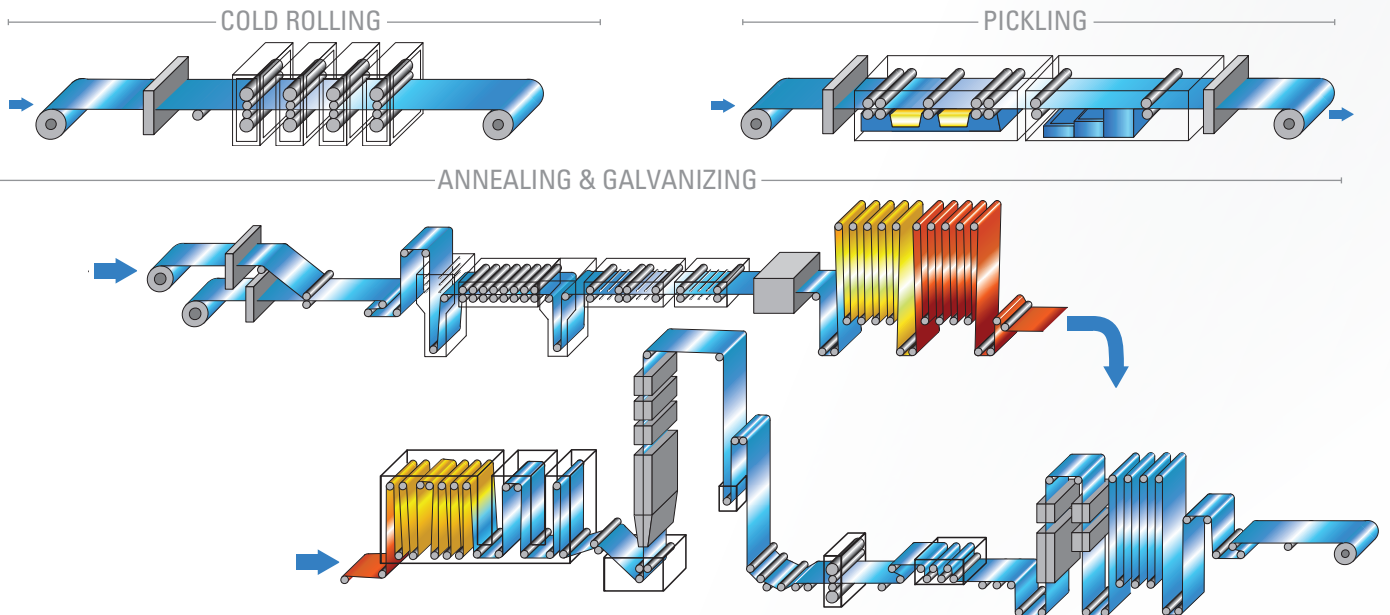



**SECTION C
HOT ROLLING MILLS**

- DescaleJet® Pro nozzles and headers
- FlatJet® nozzles
- FloodJet® nozzles
- FullJet® nozzles
- Laminar flow headers
- MFP FullJet nozzles
- VeeJet® nozzles and headers

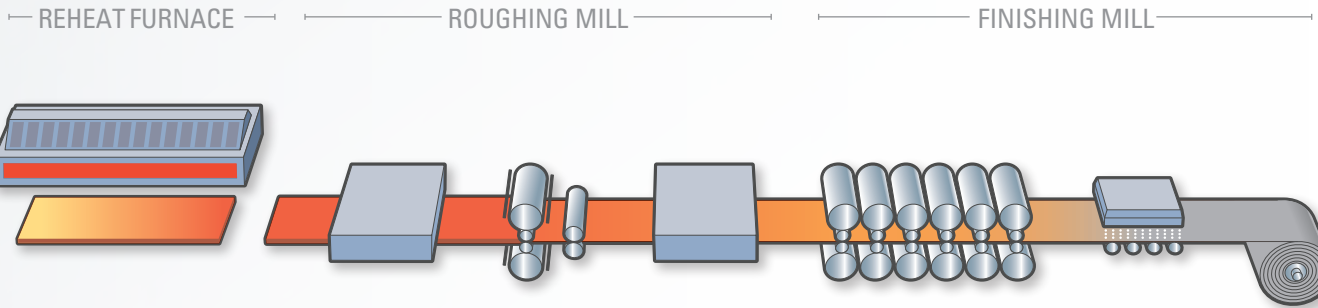

**SECTION E
IRON AND STEELMAKING**

- Air atomizing nozzles
- FloMax® nozzles
- FullJet nozzles
- UniJet® nozzles
- Spray lances

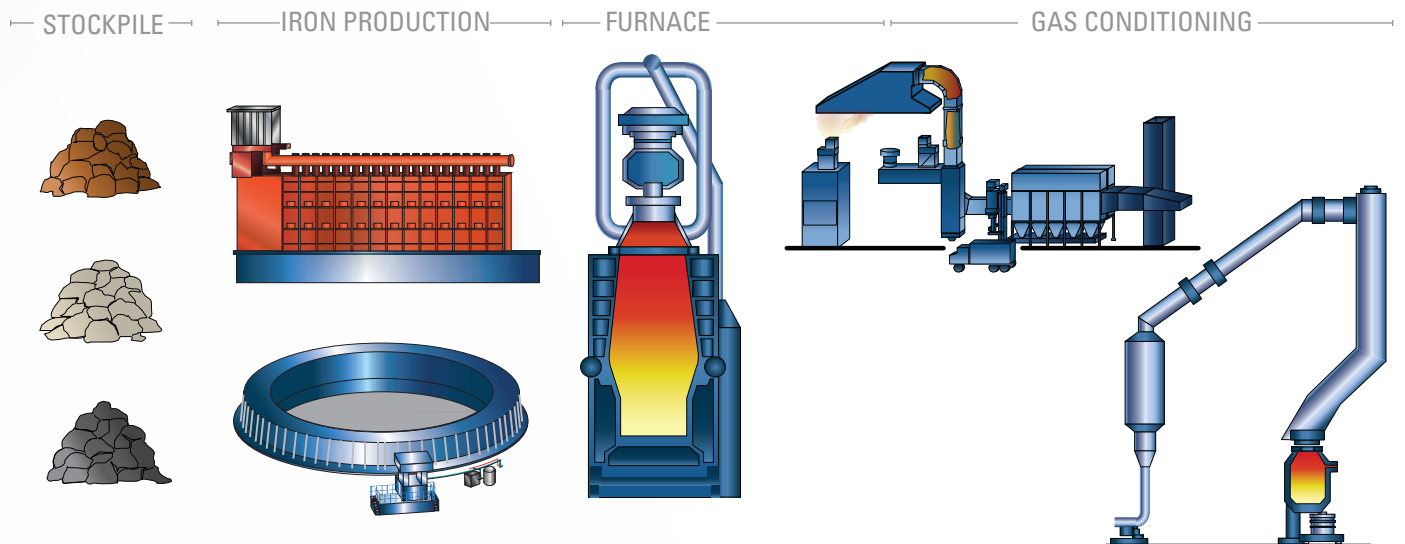

TRADEMARK REGISTRATION AND OWNERSHIP

SPRAYING SYSTEMS CO.'S TRADEMARK USAGE

The following is a current list of Spraying Systems Co.'s trademarks registered in the United States. Some marks are registered in other countries as well.

AutoJet®	FullJet®
CasterJet®	IMEG®
DescaleJet®	PulsaJet®
DescaleWare®	SpiralJet®
DistriboJet®	UniJet®
FlatJet®	VeeJet®
FloMax®	WashJet®
FloodJet®	WhirlJet®
	WindJet®

REGISTERED TRADEMARK CREDITS

The following trademarks are registered to other entities in the US and may be registered in other countries as well.

AMPCO®	INCONEL
ANSI®	MONEL®
ASTM®	REFRAX®
CARPENTER®	Stellite®
CUPRO®	Viton®
HASTELLOY®	

Spraying Systems Co. reserves the right to make changes in specifications or design of the products shown in the catalog or to add improvements at anytime without notice or obligation.





FABRICATION AND TESTING

IMPACT • DROP SIZE • DISTRIBUTION
HEADERS • LANCES • HEAT TRANSFER
COMPUTATIONAL FLUID DYNAMICS
COOLING CALCULATIONS • WEAR
TESTING • HEADERS • LANCES





FABRICATION AND TESTING
INTRODUCTION

UNIQUE MODELING, TESTING AND FABRICATION SERVICES HELP ENSURE OPTIMAL PROCESS QUALITY

The most critical components in any spray system are the spray nozzles. Choosing the nozzles that will deliver the precise performance required for your operation is essential to quality. Impact, flow rate, coverage, heat transfer and other factors can make the difference between clean, scale-free steel and dirty, streaky, dimpled and uneven products that require rework or have to be scrapped.







Once the nozzles are selected it is just as important to evaluate placement/positioning and the equipment that feeds the nozzles. Having properly designed headers/manifolds and lances is also essential to producing high quality products. Inadequate fluid flow or improper placement of the nozzles can result in inadequate cooling, descaling and coating.

We work closely with customers to optimize quality and efficiency. This begins with nozzle selection and header design. In some cases, we use our spray laboratories to validate performance or troubleshoot existing problems. When actual operating conditions cannot be simulated in our labs, we often use sophisticated modeling tools such as Computational Fluid Dynamics (CFD) and proprietary software for gas cooling to help predict performance once installed in the mill.



In addition to assisting with nozzle selection, we often fabricate the headers and lances required to ensure optimal performance. Single source supply of nozzles and headers provides convenience in addition to eliminating any equipment compatibility issues.

FABRICATION AND TESTING
TABLE OF CONTENTS

TESTING AND ANALYSIS SERVICES

	PAGE
 Impact testing	A4
 Descale header design	A4
 Roll cooling analysis	A5
 Computational Fluid Dynamics (CFD) modeling	A5
 Spray characterization	A6
 Wear testing	A6

FABRICATED PRODUCTS

	PAGE
 Spray headers	A7
 Spray lances	A7

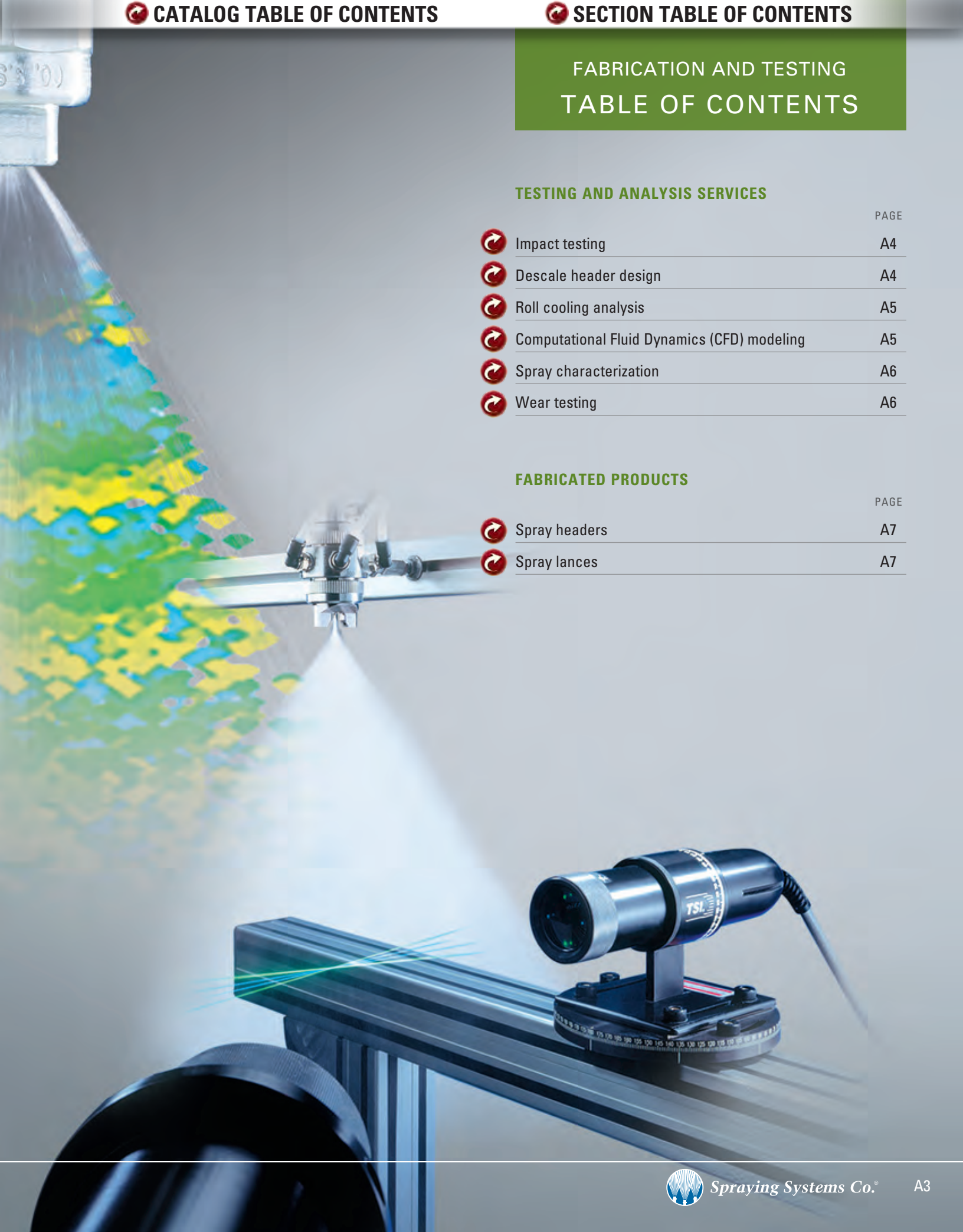

IMPACT TESTING

OVERVIEW:

Impact can be calculated using theoretical calculations. However, these calculations do not account for turbulence, spray rebound and splash back – all of which can have a significant effect on impact. To determine actual impact, the data must be collected and analyzed. In the absence of a commercially-available piece of test equipment that measured all the required attributes, we designed our own impact tester to collect data on two axes. From this, we can determine the impact force, lateral distribution and transverse distribution.

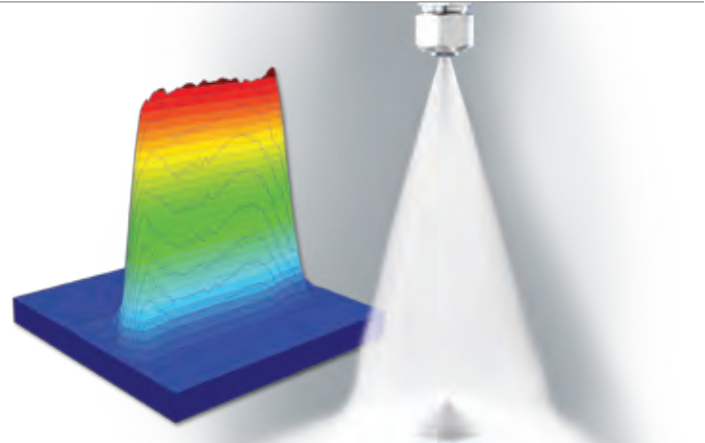

HOW THE IMPACT TESTER WORKS:

We typically compare performance of several different nozzles using different operating conditions to ensure optimal scale removal.

- The load cell of the impact tester first moves to the outside of the spray pattern
- It then traverses through the spray taking measurements at predetermined intervals
- The load cell continues back and forth through the spray unit until the entire spray area has been covered
- The data from the testing provides coverage information, impact pressure values and the uniformity of the impact distribution across the spray pattern

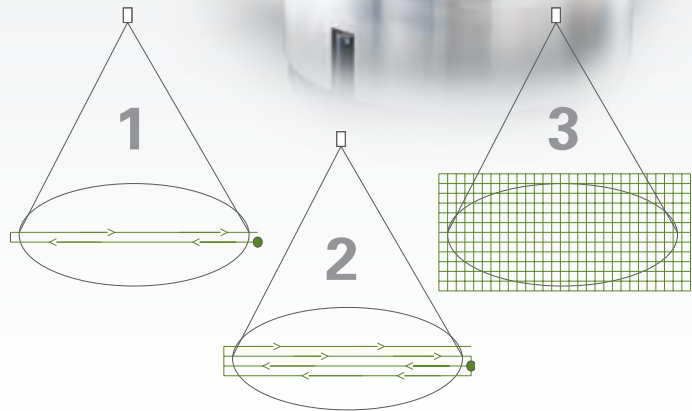

For more information on impact testing and to learn more about how it can improve your descaling operations, contact your local steel specialist.

DESCALE HEADER DESIGN

OVERVIEW:

DescaleWare®, our proprietary software for header layout and nozzle selection, helps ensure the best possible results in your operating environment.

The software:

- Determines which nozzles provide the desired performance in your environment
- Graphically displays the header layout including nozzle type, spacing, coverage, spray height, lead angle and impact values
- Is suitable for use with all steel shapes



For more information about DescaleWare, contact your local steel specialist.

ROLL COOLING ANALYSIS

OVERVIEW:

We offer a full-range of services for roll cooling optimization:

- Analysis to determine the current profile and recommendations on how to improve the profile distribution. This includes evaluation of spray patterns, nozzle and header locations
- Heat transfer analysis and recommendations on possible changes to the current roll cooling configuration to improve performance including how best to use available water

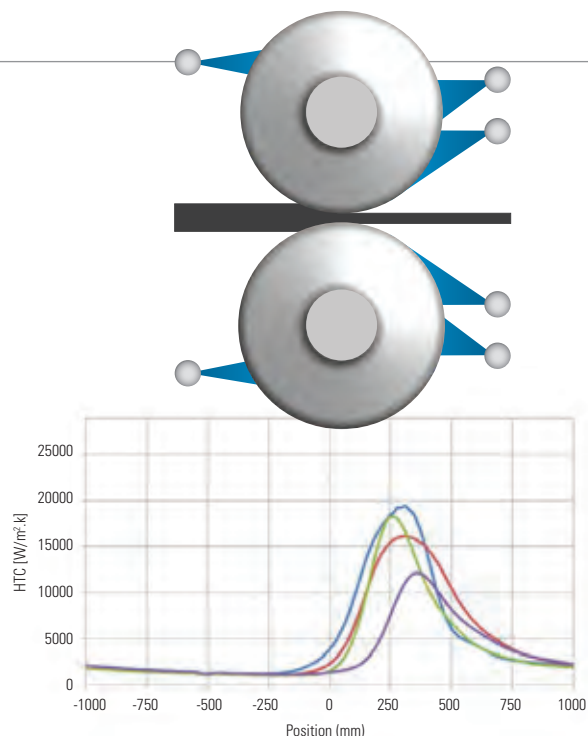

COMPUTATIONAL FLUID DYNAMICS (CFD) MODELING

OVERVIEW:

We use Computational Fluid Dynamics (CFD) modeling to help achieve an optimized spray solution. Simulation provides more information about the key factors that impact the success of an application. Modeling allows us to investigate many parameters that may be difficult or impossible to replicate in a laboratory environment. Our models use known inputs collected in our spray laboratories instead of theoretical data. This proprietary data improves model accuracy and illustrates flow patterns, velocity, turbulence, droplet trajectories, internal system pressure and more.

Typical uses for CFD modeling include:

- Determination of optimal header size and nozzle placement
- Descale header design validation
- Turbulence analysis in descale header design
- Gas cooling/conditioning analysis to determine lance and nozzle placement in ducts, scrubbers, furnaces, cooling towers and more
- Internal flow characteristics of spray nozzles under specific operating conditions

For more information about CFD modeling, contact your local steel specialist.

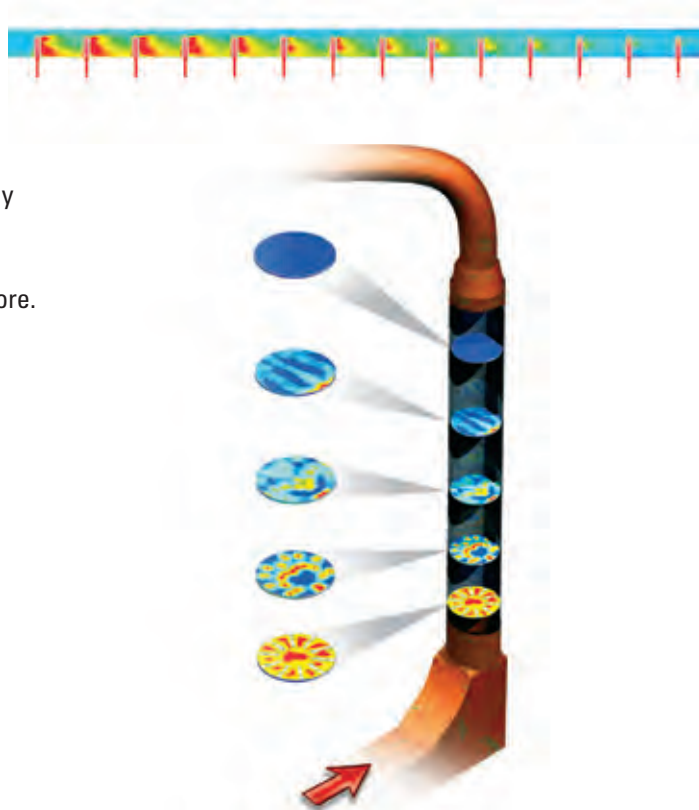

SPRAY CHARACTERIZATION

OVERVIEW:

In operations where spray performance is critical, it is important to understand how factors like these affect performance:

- Process conditions such as pressure, temperature and variable line speeds
- The liquid being sprayed
- The placement and position of nozzles in relation to the target

In many cases, experience and theoretical calculations can provide an indication of actual spray performance. However, testing in our spray labs determines actual performance and can eliminate costly specification mistakes or quality problems after installation.

While testing in our labs, we can adjust operating conditions and/or test different nozzles to find the exact performance required for your operation.

Common tests include:

- Spray characterization
- Spray angle
- Drop size distribution
- Evaporation rate
- Spray impact
- Residence time
- Spray pattern
- Dwell time
- Spray coverage

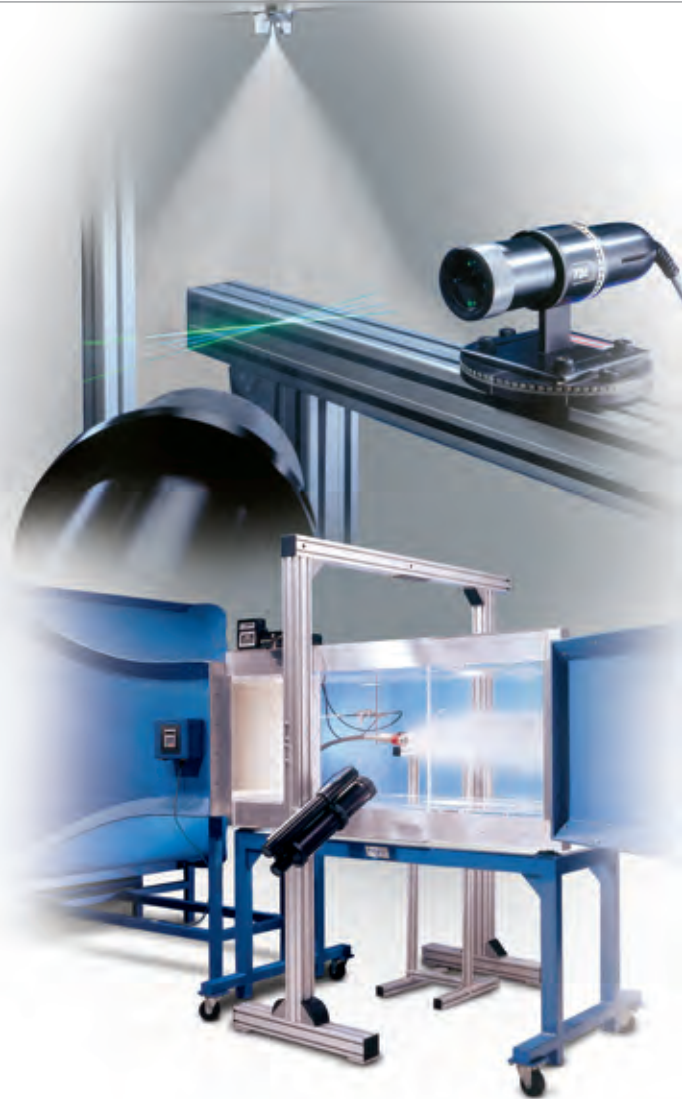

WEAR TESTING

OVERVIEW:

Descalé nozzles are manufactured to exacting standards to deliver very precise performance. And, like any precision component, nozzles will wear over time. This wear is not always visible – especially in the early stages. However, even slight wear (10 to 15%) can cost thousands of dollars per month in wasted water, energy and disposal costs. In addition, you may experience quality problems since wear compromises impact pressure.

We offer a free nozzle wear testing program for our customers. Program details:

- Ship nozzles from various points on a single header to us after they've been in use for several months
- Tests will be conducted in our spray labs to determine the wear rate
- Your nozzles will be returned to you along with recommendations for optimal replacement intervals

Contact your local steel specialist for complete details.



SPRAY HEADERS

OVERVIEW:

Whether you require a spray header for descaling, cooling, cleaning or rinsing we can help. We design and build headers for a wide range of operations throughout your mill. Headers can be built in a wide range of shapes, styles and materials to accommodate any nozzle type.

SPRAY HEADER TYPES:

- **Descal headers** – round, square or straight headers designed for high pressure operation
- **Roll cooling headers** – can be equipped with a wide range of nozzles, including different sizes or types on a single header; multi-row headers also available
- **Oiling headers** – options include zone-control, heated, non-heated and recirculating designs
- **Brushless spray headers**
 - PVDF headers equipped with PVDF nozzles for use on pickling lines or prior to galvanizing
 - Stainless steel headers for strip cleaning prior to galvanizing
- **Self-cleaning spray headers with internal rotating brushes** – ideal for use with recirculated or basin water; automatic and manual versions available
- **Laminar flow headers** – standard and slit-style versions are available for efficient, cost-effective cooling

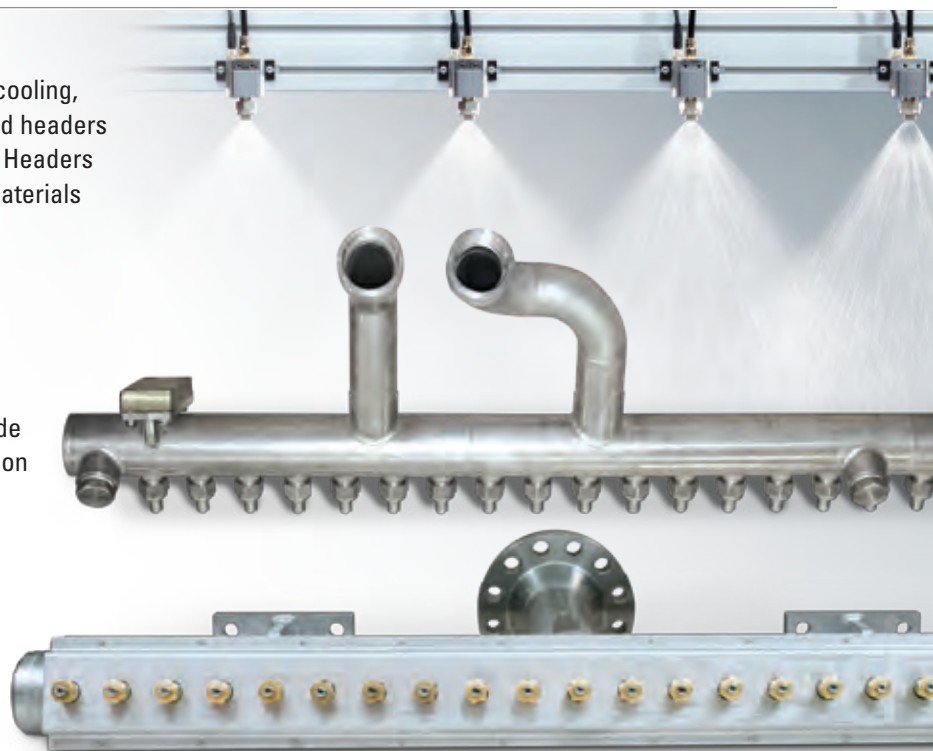

SPRAY LANCES

OVERVIEW:

Spray lances are most commonly used in conjunction with gas cooling nozzles such as our FloMax® nozzles. Typical installation is in ducts, towers and furnaces. Spray lances are built-to-order. The more common designs include:

- 0°, 45° or 90° lance configurations with quick release or bolt-on flanges and optional cooling jackets, purge tubes and protective tubes
- Multiple nozzle lances with inline or nozzles clusters

When solutions are needed to meet challenging physical spaces or hostile environments, we can design and manufacture lances in a wide range of styles including insulated, water- and steam-jacketed, recirculating and retractable, in high-temperature and corrosion-resistant materials. If required, manufacturing to meet local codes is available along with testing in accordance with ANSI® and ASTM® standards.

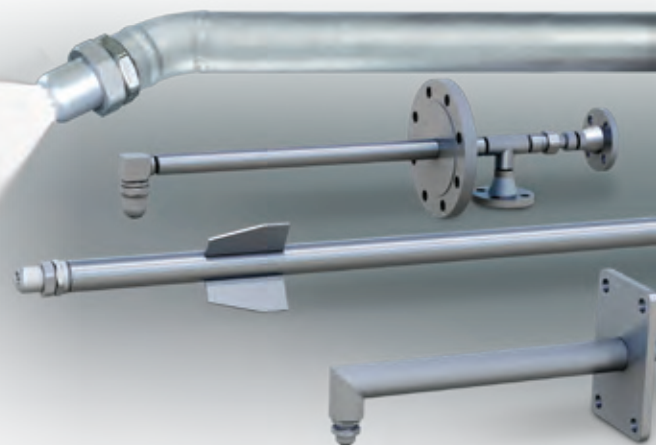

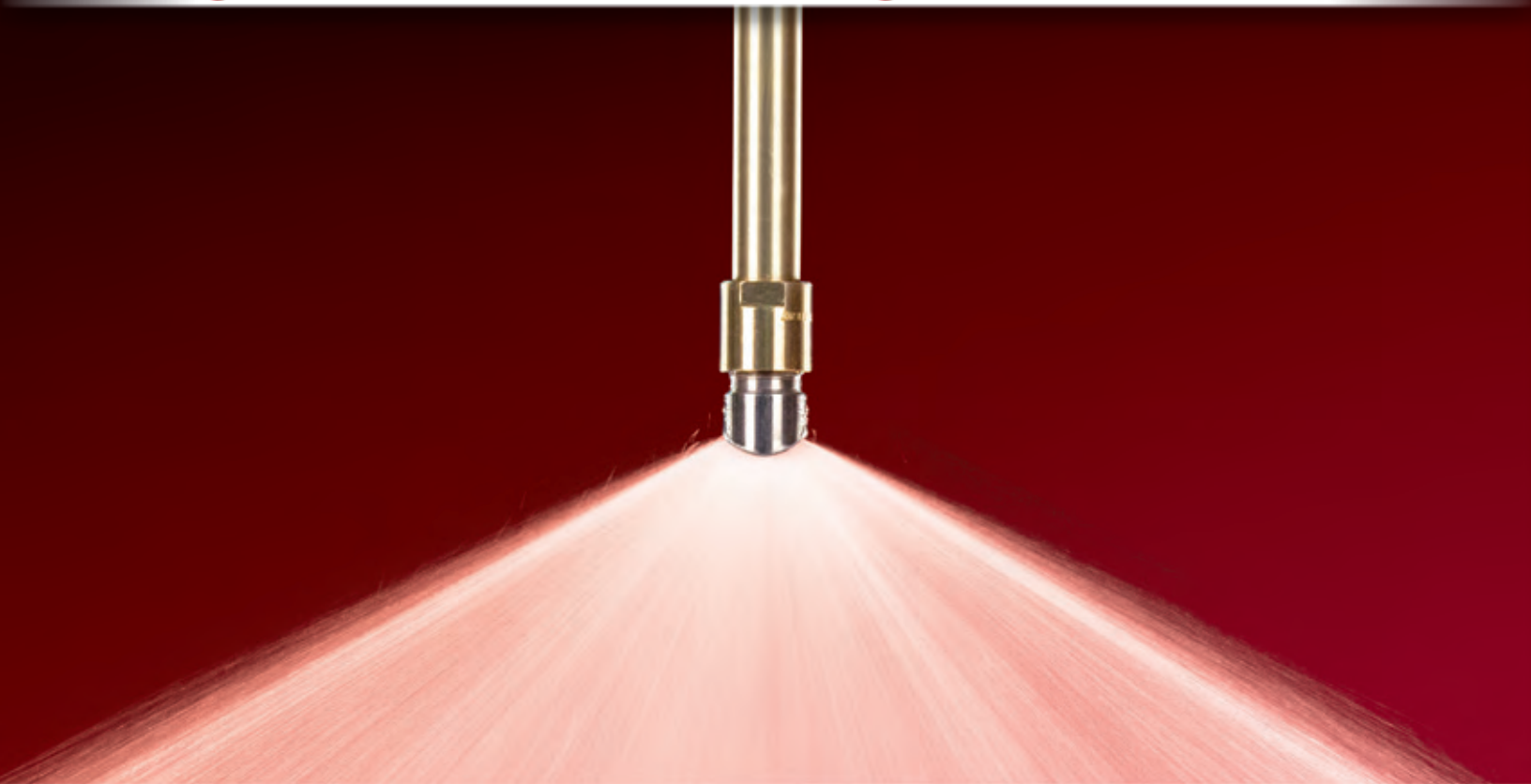

SOLUTIONS FOR CONTINUOUS CASTING

SLAB COOLING • BILLET COOLING
BLOOM COOLING • ROLL COOLING
THIN SLAB COOLING • WASHING
SECONDARY COOLING • RINSING



CONTINUOUS CASTING
INTRODUCTION

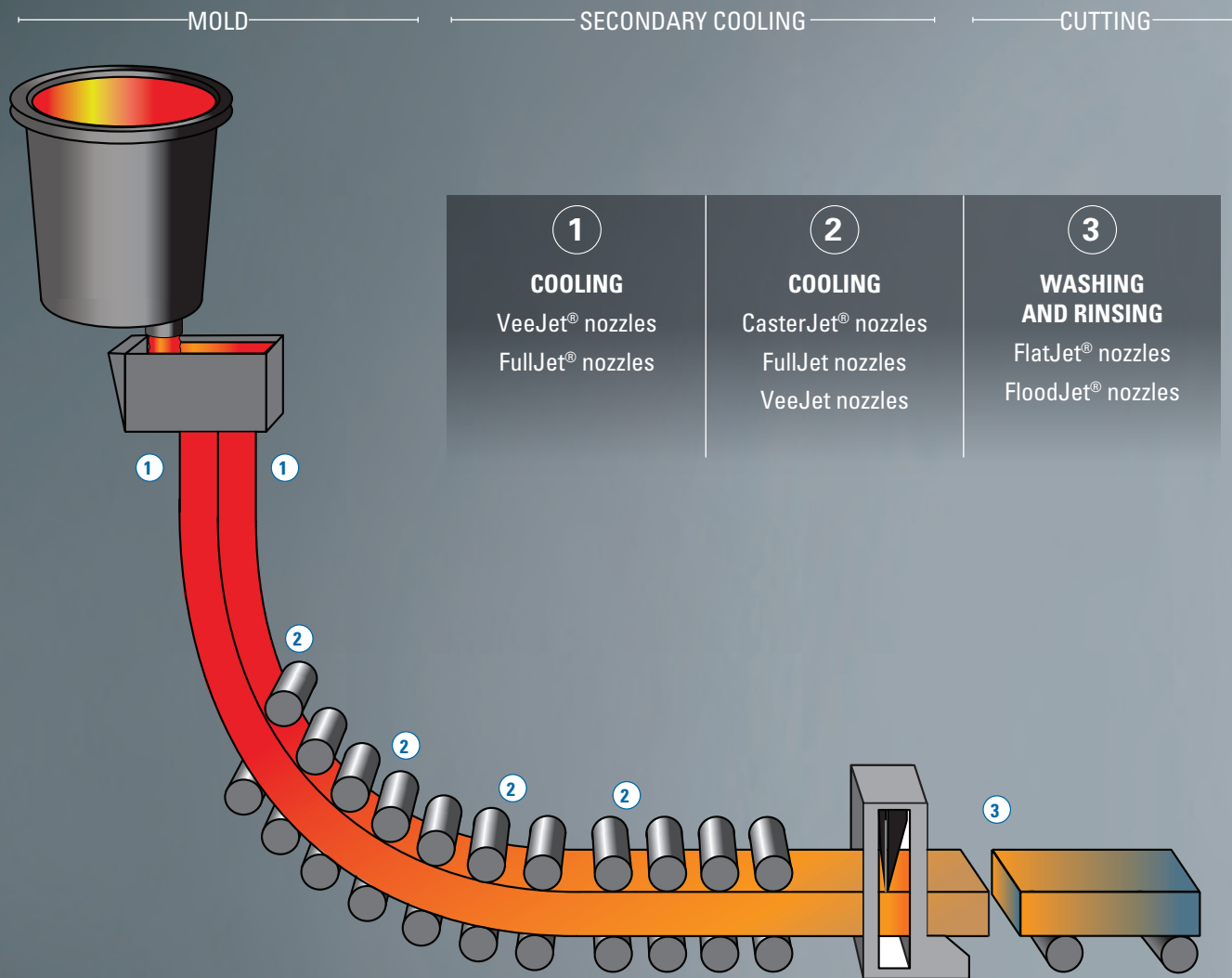

RELY ON THE INDUSTRY'S HIGHEST QUALITY NOZZLES FOR COOLING STEEL

For consistent, controlled cooling, you'll find the nozzles you need in our full line. Air mist and hydraulic nozzles are available in a wide range of styles, sizes, flow rates, spray angles and spray patterns. If you're running different widths and grades of steel, our CasterJet nozzles can help improve surface quality, reduce air and water consumption and lower maintenance time. For additional cooling and quenching, our FullJet nozzles provide uniform sprays over a wide range of flow rates and pressures. Our technical experts and sales engineers are available around the globe to assist with caster performance evaluation, heat transfer analysis, spray performance testing, special designs to fit on existing equipment and more. **Contact your local steel specialist to learn more.**



**CONTINUOUS CASTING
TABLE OF CONTENTS**

AIR MIST

FLAT SPRAY NOZZLES

50070, 50085, 56780 and 64010 NCJ CasterJet® nozzles

OVERVIEW PAGE	PERFORMANCE	
	ENGLISH	METRIC

B4 ▶ G4 ▶ G70 ▶

D40208 CasterJet nozzles

B4 ▶ G5 ▶ G71 ▶

D41968 and D41936 anti-pulsing CasterJet nozzles

B4 ▶ G6 ▶ G72 ▶

FULL CONE NOZZLES

58050 CasterJet nozzles

B5 ▶ G9 ▶ G75 ▶

58160 CasterJet nozzles

B5 ▶ G9 ▶ G75 ▶

D40206 CasterJet nozzles

B5 ▶ G10 ▶ G76 ▶

RECTANGULAR SPRAY NOZZLES

D41502 CasterJet nozzles

B6 ▶ G14 ▶ G80 ▶

IMPINGEMENT COOLING NOZZLES

26010-1/4J nozzles

B6 ▶ G17 ▶ G83 ▶

HYDRAULIC – SPECIALTY COOLING NOZZLES

FULL CONE NOZZLES

HHCC FullJet® nozzles

OVERVIEW PAGE	PERFORMANCE	
	ENGLISH	METRIC

B8 ▶ G11 ▶ G77 ▶

HHX FullJet nozzles

B8 ▶ G12 ▶ G78 ▶

P45075 FullJet nozzles

B8 ▶ G13 ▶ G79 ▶

RECTANGULAR SPRAY NOZZLES

25381, D41828 and D41539 spray tips

B9 ▶ G15-16 ▶ G81-82 ▶

FLAT SPRAY NOZZLES

23530-XT and 58090-XT VeeJet® nozzles

B9 ▶ G7 ▶ G73 ▶

49784-XT VeeJet spray tips

B9 ▶ G8 ▶ G74 ▶

56862 nozzles

B9 ▶ G8 ▶ G74 ▶

HYDRAULIC – STANDARD COOLING NOZZLES

FULL CONE NOZZLES

G, GG, GA and GGA FullJet nozzles

B11 ▶ G48 ▶ G114 ▶

H and HH FullJet nozzles

B11 ▶ G48 ▶ G114 ▶

VK nozzles

B11 ▶ G56 ▶ G122 ▶

SQUARE SPRAY NOZZLES

G-SQ, GG-SQ and HH-SQ FullJet nozzles

B13 ▶ G60 ▶ G126 ▶

OVAL SPRAY NOZZLES

G-VL, GG-VL and HH-VL FullJet nozzles

B13 ▶ G62 ▶ G128 ▶

VANELESS NOZZLES

GANV and GGANV FullJet nozzles

B13 ▶ G57 ▶ G123 ▶

MORE FULL CONE NOZZLES:
SEE SECTIONS C AND E

MORE FLAT SPRAY NOZZLES:
SEE SECTIONS C AND D



OVERVIEW: CASTERJET® FLAT SPRAY NOZZLES

- Specifically designed for highly efficient secondary cooling in the caster
- High heat transfer rates achieved using patented atomization technology to reduce compressed air consumption and lower costs
- Large variety of nozzle configurations to accommodate most space and access requirements
- Wide range of stable spray patterns for controlled zone cooling
- Fine drops evaporate quickly and reduce water build-up under rolls
- Easy tip and tube replacement to minimize downtime when breakouts occur

CASTERJET NOZZLE OPTIONS

50070/50085/56780 NCJ CasterJet nozzles

- Unique mixing process provides uniform spray distribution and even cooling using less water and up to 25% less compressed air. Existing caster lines may be able to turn off some compressors and new lines may require fewer compressors
- Turndown ratio of 25:1 allows flow to be reduced using water pressures as low as 5 psi (.3 bar) without a loss in performance to accommodate a wide range of steel types and allows
- Large free passages allow contaminants to pass through the nozzle
- Ideal for slab and thin slab cooling



64010 compact CasterJet nozzles

- Design, performance and benefits comparable to 50070/50085/56780 CasterJet nozzles
- Produces a consistent, uniform drop size distribution across the spray pattern
- Large free passages reduce the risk of clogging
- Ideal for slab cooling in continuous casters with limited frame space or small roll gaps



D40208 block-style CasterJet nozzles

- Compact design permits installation close to slab; spray distance is reduced and cooling efficiency improved
- Positive alignment of spray tip reduces installation errors
- Clog-resistant design
- Ideal for slab cooling



D41968/D41936 anti-pulsing CasterJet nozzles

- Anti-pulsing feature provides constant flow and high heat transfer rates even at low operating pressures
- Uniform water distribution over the entire slab width
- Vertical plate connection simplifies maintenance
- Ideal for slab and beam blank continuous casting



OVERVIEW: FULL CONE, RECTANGULAR AND IMPINGEMENT COOLING NOZZLES

- CasterJet® nozzles
 - Uniform, stable flows that are unaffected by pressure changes
 - Low flow operation reduces water use
 - Large, open flow passages allow contaminants to pass through the nozzles
- D41502 nozzles provide a rectangular spray pattern with large coverage area
- 26010-1/4J nozzles provide softer, impingement-type cooling

FULL CONE, RECTANGULAR AND IMPINGEMENT COOLING NOZZLE OPTIONS

58050 CasterJet nozzles

- Similar design to 50070/50080 CasterJet nozzles with a full cone spray
- Ideal for billet, bloom and pipe continuous casting
- Removable inlets enable quick and easy replacement
- Detachable extension tube allows fast tube and tip replacement



58160 block-style CasterJet nozzles

- Same design as 58050 with a full cone spray in a compact package for areas with minimal space
- Back of nozzle includes O-ring grooves and a threaded or through-hole for mounting
- Available with inlets drilled into the block or threaded inlets for easy cleaning
- Ideal for billet, bloom and pipe continuous casting



D40206 block-style CasterJet nozzles

- Fine droplets in round full cone spray pattern provide effective cooling
- Compact design allows use in areas with limited space
- Ideal for bloom, billet and round continuous casting



FULL CONE, RECTANGULAR AND IMPINGEMENT COOLING NOZZLE OPTIONS

D41502 block-style CasterJet® nozzles

- Use in areas with limited space
- Large rectangular spray coverage
- Reduce use of air and water
- Designed for use in areas with limited space; can be positioned lengthwise as needed
- Ideal for bloom, billet, beam blank and round continuous casting



26010-1/4J impingement style nozzles

- Provides softer cooling – similar to cooling achieved with hydraulic nozzles
- Rings on air cap give visual identification of performance rating to facilitate installation and change out
- Often used in facilities running a small number of steel grades
- Ideal for billet and bloom cooling



Drop Size Comparison Between Hydraulic and Air Mist Nozzles

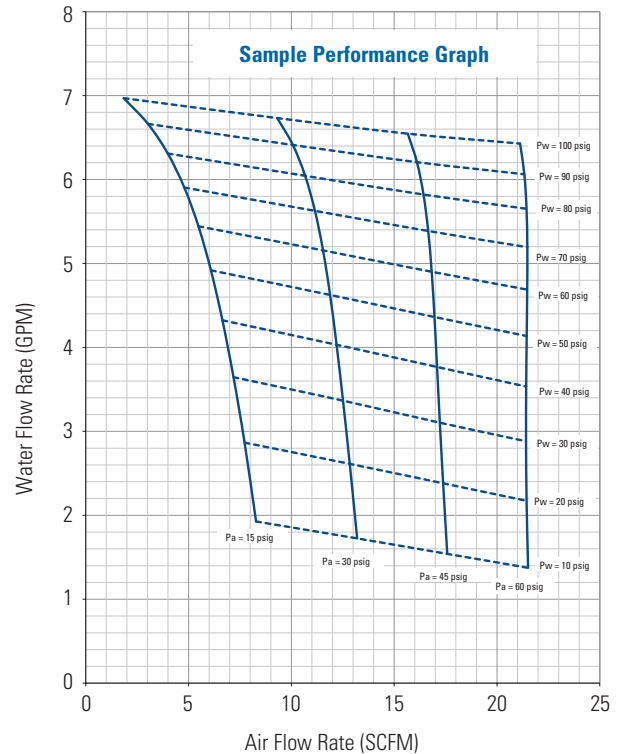
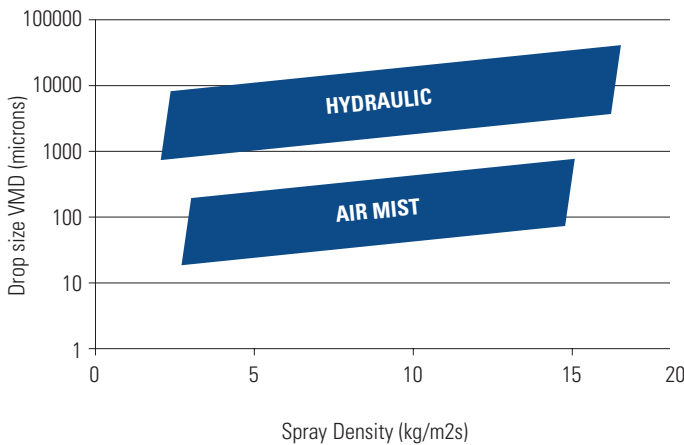

PLACING YOUR ORDER

Call your local steel specialist for application assistance or to place an order.

FOR DETAILED NOZZLE PERFORMANCE DATA, SEE spray.com/steeltcatalog/sectionB



AIR MIST NOZZLE QUICK REFERENCE GUIDE

Model	Spray Type	Spray Angle	Size	Air Pressure = 45 psi (3 bar) Water Pressure = 100 psi (7 bar)	
				Water Flow gpm (lpm)	Air Flow scfm (Nm ³ /h)
50070/56780 NCJ CasterJet®	Flat	60° to 135°	2.0 - 6.5	2.0 to 6.5 (7.6 to 24.6)	5.2 to 15.5 (8.4 to 25.0)
50085 NCJ CasterJet	Flat	60° to 135°	8.0 - 12.0	8.0 to 12.0 (30.3 to 45.4)	18.0 to 23.0 (28.9 to 36.9)
64010 compact CasterJet	Flat	60° to 135°	2.0 - 7.0	2.0 to 7.0 (7.6 to 26.5)	5.2 to 16.3 (8.4 to 26.2)
D40208 block-style CasterJet	Flat	30° to 140°	480 - 850	1.3 to 10.3 (4.8 to 39.0)	1.6 to 8.0 (2.6 to 12.8)
D41968/D41936 anti-pulsing CasterJet	Flat	40° to 120°	0.7 - 8.0	0.8 to 6.9 (2.9 to 26.0)	0.8 to 5.9 (1.3 to 9.5)
58050 CasterJet	Full cone	45°, 60°, 90°	075 - 090	0.4 to 0.9 (1.5 to 3.4)	2.4 to 3.8 (3.9 to 6.1)
58160 block-style CasterJet	Full cone	45°, 60°, 90°	075 - 210	0.7 to 2.1 (2.6 to 7.9)	4.7 to 10 (7.5 to 16.0)
D40206 block-style CasterJet	Full cone	60° to 90°	400 - 640	0.6 to 3.8 (2.1 to 14.2)	3.7 to 8.4 (5.9 to 13.5)
D41502 CasterJet	Rectangular	70° to 120°	450 - 610	0.8 to 3.2 (2.9 to 12.0)	3.2 to 5.2 (5.1 to 8.4)
26010-1/4J impingement cooling	Flat	90° to 120°	0 - 5	0.5 to 2.8 (1.9 to 10.6)	3.0 to 10.5 (5.1 to 17.82)

NOTE: Nozzle sizing and performance depends on machine size and requirements. For more detailed information or assistance with CasterJet products, contact your local steel specialist.

PLACING YOUR ORDER

**Call your local steel specialist for
application assistance or to place an order.**

**FOR DETAILED NOZZLE PERFORMANCE DATA, SEE
spray.com/steeltatalog/sectionB**

OVERVIEW: SPECIALTY COOLING FULLJET® FULL CONE NOZZLES

- Designed specifically for demanding conditions in steel mills. Staked-in vane design won't loosen during caster operation
- More uniform distribution across the entire spray pattern than other full cone nozzles to ensure consistent and controlled cooling
- Spray angle is unaffected by changes in operating pressure allowing for wider variations in casting speeds
- Use different HHCC nozzle sizes to obtain the needed mass water flux; a nominal flow rate increase of 25% at every size increment simplifies flow layout for each segment
- Low profile design is suitable for use on risers in billet casters
- Hex body allows the use of standard sockets for easy installation and removal
- Ideal for use in mini mills and on high-speed continuous casting machines

SPECIALTY COOLING FULLJET NOZZLE OPTIONS

 <p>HHCC 1/8" to 1/2" male conn. Staked-in vane</p>	 <p>HHX 1/4" to 3/8" male conn. Staked-in vane</p>	 <p>P45075 1/4" to 3/8" female conn. Staked-in vane</p>	 <p>HHCC (top) and HHX FullJet (bottom) full cone nozzle spray comparison using laser sheet imaging in our spray laboratories.*</p>
--	---	---	---

*The light intensity in the spray is directly proportional to the volume of liquid. Red is the highest light intensity, which is the heaviest volume in the spray. Black is the lowest or no light intensity.

SPECIALTY COOLING FULLJET NOZZLE QUICK REFERENCE GUIDE

Model	Connection/Type	Connection Size (in.)	Flow Rate Range gpm (lpm)	Spray Angle	Materials
HHCC	M	1/8 to 1/2 NPT	0.65 to 9.4 (2.5 to 35.6)	68° to 74°	Brass, 303 stainless steel
HHX	M	1/4 to 3/8 NPT	0.36 to 7.8 (1.6 to 6.2)	45° to 90°	Brass, 303 stainless steel
P45075	F	1/4 to 3/8 BSPP	0.42 to 5.6 (1.6 to 22)	45° to 120°	Brass, 303 stainless steel

F = female thread; M = male thread.

PLACING YOUR ORDER







Call your local steel specialist for application assistance or to place an order.

FOR DETAILED NOZZLE PERFORMANCE DATA, SEE spray.com/steeltcatalog/sectionB

OVERVIEW: SPECIALTY COOLING RECTANGULAR AND FLAT SPRAY NOZZLES

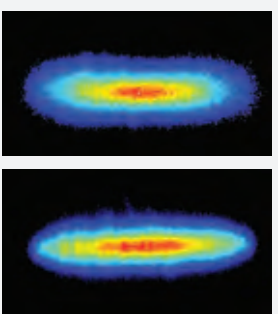
- Designed specifically for demanding conditions in steel mills; ideal for slab casting
- 25381 spray tips produce a thick, rectangular, uniform pattern and feature a smaller orifice to minimize fluttering and maximize cooling efficiency. Widely used in upper section cooling in slab, billet and bloom casting
- New D41828 spray tips provide similar performance to 25381 spray tips but feature a design optimized for efficient heat transfer
- D41539 rectangular spray tips are ideal for cooling billets and blooms
- VeeJet® XT flat spray nozzles produce an extra-thick spray with a transverse spray angle of 20° and 30° for use with different shapes
- 49784 dovetail spray tips are ideal for roll cooling operations where alignment is critical
- 56862 cross spray nozzles produce an extra heavy edge pattern; ideal for cooling two rolls in a caster with a single nozzle

SPECIALTY COOLING RECTANGULAR AND VEEJET FLAT SPRAY NOZZLE OPTIONS

 <p>25381 dovetail spray tip</p>	 <p>D41828 dovetail spray tip</p>	 <p>D41539 spray tip Steel positioning pin</p>	 <p>VeeJet XT (top) and standard VeeJet (bottom) nozzle spray comparison using laser sheet imaging in our spray laboratories.*</p>
 <p>23530-XT 3/8" male conn. One-piece body</p>	 <p>58090-XT 1/4" to 3/8" male conn. One-piece body</p>	 <p>49784-XT dovetail spray tip</p>	 <p>56862 1/2" male conn. One-piece body</p>

*The light intensity in the spray is directly proportional to the volume of liquid. Red is the highest light intensity, which is the heaviest volume in the spray. Black is the lowest or no light intensity.

SPECIALTY COOLING RECTANGULAR AND VEEJET® FLAT SPRAY NOZZLE
QUICK REFERENCE GUIDE

Model	Connection/Type	Connection Size (in.)	Flow Rate Range gpm (lpm)	Materials
25381/D41828	Dovetail tip; threaded and weld body options	NA	0.44 to 20.1 (1.7 to 76.1)	Brass, 303 stainless steel
D41539	Special	1.34	1.1 to 9.1 (3.6 to 34)	Brass
23530-XT	M	3/8	0.8 to 4.5 (3.5 to 14.7)	Brass, 303 stainless steel
58090-XT	M	1/4 to 3/8	1.0 to 8.9 (4.7 to 28.3)	Brass, 303 stainless steel
49784-XT	Dovetail tip; threaded and weld body options	NA	1.4 to 21.9 (6.4 to 81)	Brass, 303 stainless steel
56862	M	1/2	1.1 to 4.8 (4.7 to 14.8)	303 stainless steel

F = female thread; M = male thread.

Heat Transfer Comparison Curve and Distribution Data for Specialty Cooling Nozzles

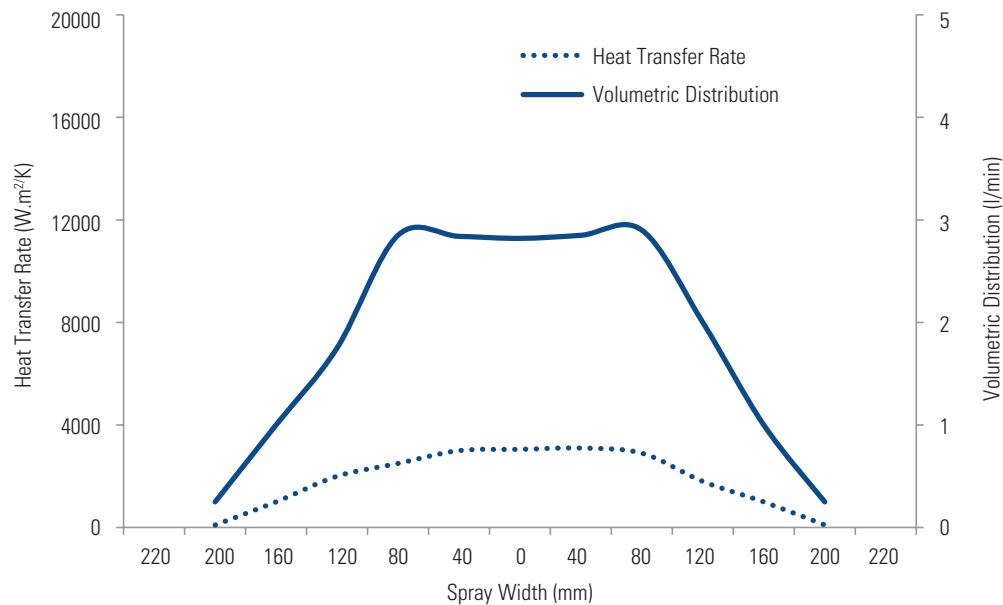

PLACING YOUR ORDER

Call your local steel specialist for application assistance or to place an order.

FOR DETAILED NOZZLE PERFORMANCE DATA, SEE spray.com/steeltatalog/sectionB



OVERVIEW: FULL CONE FULLJET® NOZZLES

G and H FullJet nozzles:

- Solid cone-shaped spray pattern with round impact area
- Unique vane design minimizes turbulence and ensures uniform cooling
- Large, unobstructed flow passages minimize clogging
- G, GG, GA and GGA models provide uniform spray distribution from .10 to 13.9 gpm (.38 to 52 lpm) at operating pressures up to 300 psi (20 bar); spray angles from 43° to 94°
- H and HH models provide uniform spray distribution from .10 to 49 gpm (.38 to 183 lpm) at operating pressure up to 300 psi; spray angles from 46° to 94°
- Ideal for cooling billets, blooms and narrow side slab castings

VK FullJet nozzles:

- Solid cone-shaped spray pattern with round impact area
- Uniform spray distribution from .16 to 26.5 gpm (.5 to 89.1 lpm) at operating pressures up to 300 psi (20 bar); spray angles from 45° to 120°
- Ideal for slab cooling

FULL CONE FULLJET NOZZLE OPTIONS



G
1/8" to 1/2" female conn.
Removable cap and vane



GG
1/8" to 1/2" male conn.
Removable cap and vane



GA
1/8" to 1/2" female conn.
Angle-type
Removable cap and vane



GGA
1/8" to 1/2" male conn.
Angle-type
Removable cap and vane



H
3/4" to 1" female conn.
One-piece body



HH
1/8" to 1" male conn.
One-piece body



VK
3/8" to 3/4" male conn.
One-piece body

FULL CONE FULLJET® NOZZLE QUICK REFERENCE GUIDE

Model	Connection/Type	Connection Size (in.)	Materials
G	F	1/8 to 1/2	Brass, mild steel, 303 stainless steel, 316 stainless steel, polyvinyl chloride
GG	M	1/8 to 1/2	
GA	F, angle-type	1/8 to 1/2	Brass, mild steel, 303 stainless steel
GGA	M, angle-type	1/8 to 1/2	
H	F	3/4 to 1	Brass, mild steel, 303 stainless steel, 316 stainless steel, polyvinyl chloride
HH	M	1/8 to 1	
VK	M	3/8 to 3/4 BSPP	Brass, 316 stainless steel, 303 stainless steel
VK	F	3/8 BSPP	Brass, 316 stainless steel, 303 stainless steel

F = female thread; M = male thread.

PLACING YOUR ORDER

Call your local steel specialist for application assistance or to place an order.

FOR DETAILED NOZZLE PERFORMANCE DATA, SEE spray.com/steeltcatalog/sectionB



OVERVIEW: SQUARE, OVAL AND VANELESS FULLJET® NOZZLES

G-SQ, GG-SQ, HH-SQ FullJet nozzles:

- Full cone square spray pattern
- Uniform spray distribution from .26 to 37 gpm (1.1 to 140 lpm) at operating pressures up to 150 psi (10 bar); spray angles from 40° to 82°
- Ideal for cooling slabs, billets, and blooms in the upper section after the mold

G-VL, GG-VL and HH-VL FullJet nozzles:

- Full cone oval spray pattern; length is approximately twice its width
- Uniform spray distribution from .59 to 3.2 gpm (2.2 to 11.9 lpm) at operating pressures up to 150 psi (10 bar); spray angles: 80° by 45° to 106° by 64°
- Ideal for cooling slabs, billets, and blooms in the upper section after the mold

GANV and GGANV FullJet nozzles:

- Full cone round spray pattern
- No vane for unrestricted flow – coarse spray is projected at 90° from axis at the inlet
- Uniform spray distribution from .35 to 23 gpm (1.4 to 87 lpm) at operating pressures up to 100 psi (7 bar); spray angles: 68° to 95°
- Ideal for use in cooling applications where clogging is a concern

SQUARE, OVAL AND VANELESS FULLJET NOZZLE OPTIONS



G-SQ
1/8" to 1/2" female conn.
Removable cap and vane



GG-SQ
1/8" to 1/2" male conn.
Removable cap and vane



HH-SQ
1/8" to 1" male conn.
One-piece body



G-VL
3/8" female conn.
Removable cap and vane



GG-VL
3/8" male conn.
Removable cap and vane



HH-VL
1/2" male conn.
One-piece body



GANV
1/4" to 1/2" female conn.
Vaneless design
Removable cap



GGANV
1/4" to 1/2" male conn.
Vaneless design
Removable cap

SQUARE, OVAL AND VANELESS FULLJET® NOZZLE QUICK REFERENCE GUIDE

Model	Connection/Type	Connection Size (in.)	Materials
G-SQ	F	1/8 to 1/4	Brass, mild steel, 303 stainless steel, 316 stainless steel
GG-SQ	M	1/8 to 1/4	Brass, mild steel, 303 stainless steel, 316 stainless steel
HH-SQ	M	1/8 to 1	Brass, mild steel, 303 stainless steel, 316 stainless steel, polyvinyl chloride
G-VL	F	3/8	Brass, 303 stainless steel
GG-VL	M	3/8	Brass, 303 stainless steel
HH-VL	M	1/2	Brass, 303 stainless steel
GANV	F	1/4 to 1/2	Brass, 303 stainless steel
GGANV	M	1/4 to 1/2	Brass, 303 stainless steel

F = female thread; M = male thread.

PLACING YOUR ORDER

Call your local steel specialist for application assistance or to place an order.

FOR DETAILED NOZZLE PERFORMANCE DATA, SEE spray.com/steeltcatalog/sectionB





SOLUTIONS FOR HOT ROLLING MILLS

DESCALING • INTERSTAND COOLING
ROLL COOLING • LAMINAR COOLING
RUNOUT TABLE COOLING • LOOSE
SCALE REMOVAL • SPOT SPRAYING



HOT ROLLING MILLS
INTRODUCTION

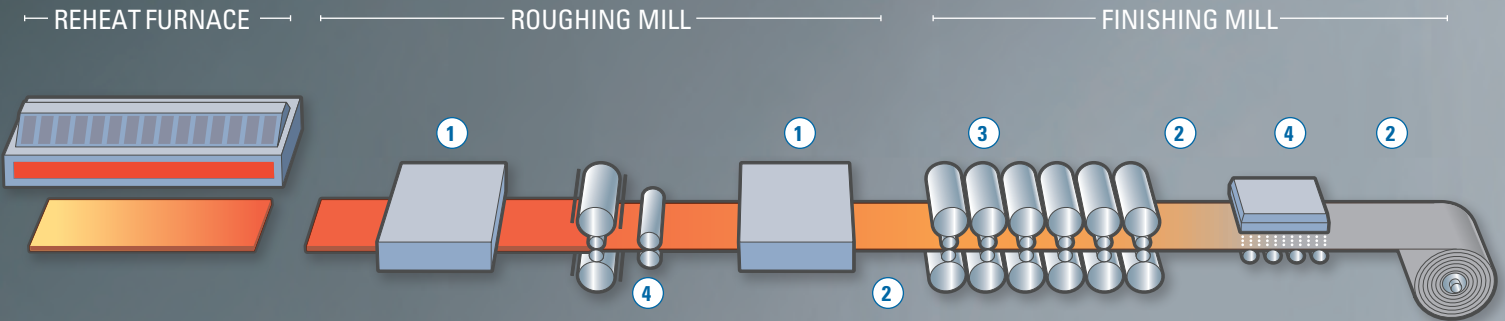

1

DESCALING

DescaleJet® Pro
nozzles and headers

2

**WASHDOWN
AND BLOW OFF**

FloodJet® nozzles
FlatJet® nozzles
WindJet® nozzles

3

ROLL COOLING

VeeJet® self-aligning
nozzles and headers

4

STRIP COOLING

FullJet® nozzles
FullJet maximum
free passage nozzles
Laminar flow headers

SPRAY TECHNOLOGY SOLUTIONS FOR EVERY AREA OF YOUR HOT ROLLING MILL

To ensure optimal steel quality, partner with Spraying Systems Co. for superior products and service. Our product offering includes a wide range of nozzles and headers, for descaling, cooling, scale removal and more. In addition, there is a local steel industry expert in your area to help assist with product selection, header and system design, cooling calculations, specialized testing and more. We have a decades-long, proven track record helping mills around the world minimize defects, reduce operating costs and simplify maintenance.

Please let us know how we can help you.



**HOT ROLLING MILLS
TABLE OF CONTENTS**

DESCALING NOZZLES

	OVERVIEW	PERFORMANCE	
	PAGE	ENGLISH	METRIC
DescalJet® Pro nozzles	C4 ▶	G18 ▶	G84 ▶
26180/26190 and AA218/AA219 DescalJet nozzles	C4 ▶	G18 ▶	G84 ▶
AA214 and Compact DescalJet nozzles	C4 ▶	G18 ▶	G84 ▶
HiScaleJet, HSJ and Mini HiScaleJet nozzles	C5 ▶	G18 ▶	G84 ▶
CVCN check valves	C5 ▶	G19 ▶	G85 ▶

FLAT SPRAY NOZZLES

18897 and FSUN-S VeeJet® spray tips	C6 ▶	G41 ▶	G107 ▶
49803 and 49807 VeeJet spray tips	C6 ▶	G43 ▶	G109 ▶
58606 VeeJet spray tips	C6 ▶	G45 ▶	G111 ▶
58600-H3/4U VeeJet nozzles	C6 ▶	G27 ▶	G93 ▶
MEG, WEG, MEG-SSTC and IMEG® WashJet® nozzles	C7 ▶	G28 ▶	G94 ▶
K and TEK FloodJet® nozzles	C8 ▶	G31-32 ▶	G98-99 ▶
P FlatJet® nozzles	C8 ▶	G33 ▶	G99 ▶

**MORE FLAT SPRAY NOZZLES:
SEE SECTIONS B AND D**

DescalWare®, our proprietary software, simplifies nozzle selection and header design by using impact and coverage data collected in our spray laboratories. The software determines which nozzles provide the desired performance and graphically displays the optimal header layout including nozzle type, spacing, coverage, spray height, lead angle and impact values.

FULL CONE NOZZLES

	OVERVIEW	PERFORMANCE	
	PAGE	ENGLISH	METRIC
H FullJet® nozzles	C9 ▶	G48 ▶	G114 ▶
Maximum Free Passage FullJet nozzles	C9 ▶	G52 ▶	G118 ▶

HEADERS

Descal headers	C10 ▶	CONTACT LOCAL STEEL SPECIALIST ▶
Laminar flow headers	C10 ▶	CONTACT LOCAL STEEL SPECIALIST ▶
VeeJet headers	C10 ▶	CONTACT LOCAL STEEL SPECIALIST ▶

**MORE FULL CONE NOZZLES:
SEE SECTIONS B AND E**



OVERVIEW: DESCALING NOZZLES

- High-impact descaling for scale-free steel
- Minimize turbulence and maximize impact
- Minimize water and pressure use without compromising performance
- Maximize effective coverage area

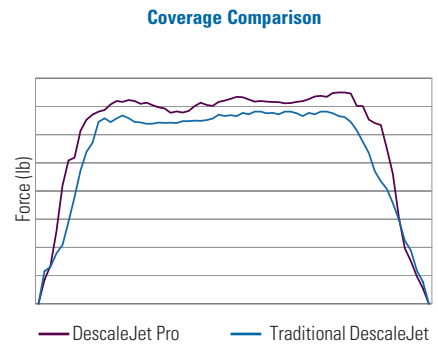
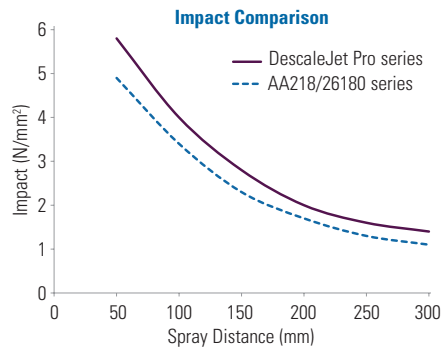

DESCALING NOZZLE OPTIONS

DescaleJet® Pro nozzles

- Advanced vane design reduces turbulence while increasing water velocity for improved impact and more effective descaling
- Orifice design produces large effective coverage and enables use of fewer nozzles and eliminates water waste
- Carbide material with finer grain structure reduces material wear and extends service life
- Wide range of threaded and weld connections, stabilizing attachments and tip bodies for easy integration in existing installations
- Ideal for thin strip, slab, plate, rounds and billets



26180/26190 DescaleJet and AA218/AA219 DescaleJet nozzles

- Internal vane and tight spray pattern increase impact
- Hardened stainless steel or tungsten carbide inserts extend service life
- Stainless steel body and spray tip holder provide protection from splashback wear and flying debris
- Self-aligning spray tips reduce maintenance/replacement time
- Flat seat design of the 26180/26190 series expedites maintenance; an internally threaded cap on AA218/AA219 protects against splashback damage
- 1" inlet connections with choice of threaded or weld bodies
- Ideal for thin strip, slab, plate, rounds and billets



AA214 DescaleJet and Compact DescaleJet nozzles

- When used at spray heights of 2" to 6" (50 to 150 mm) and placed close together on a header, these nozzles provide the same impact level of higher capacity nozzles using less water
- Fluid passages minimize turbulence and produce thin, high-impact sprays
- Tungsten carbide inserts, pressed directly in nozzle bodies, provide long wear life, reduced maintenance time and lower replacement costs
- Choice of threaded and weld connections
- Ideal for thin strip, rounds and billets



HiScaleJet, HSJ and Mini HiScaleJet nozzles

- Comparable performance to AA218/AA219 and 26180/26190 DescaleJet® nozzles but with body styles to match different header designs
- HiScaleJet and Mini HiScaleJet feature a flat seated surface and long alignment flat on the tip body for positive alignment
- HSJ features a flat seating surface and larger and durable alignment lugs at the base of the tip holder
- Ideal for thin strip, slab, plate, rounds and billets

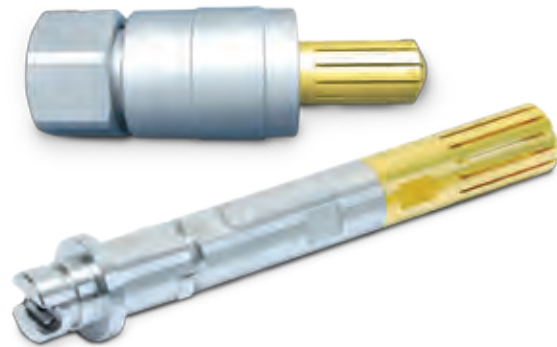

CVCN Check Valves

- Used with DescaleJet Pro nozzles, CVCN check valves prevent water from dripping after descaling and overcooling steel
- Allows faster sequencing of plates – no delays waiting for nozzles to shut off
- Eliminates water hammer effect by reducing nozzle turbulence and controlling turbulence in the header
- Minimizes pressure drop



DESCALING NOZZLE QUICK REFERENCE GUIDE

Model	Flow Rate Range at 2000 psi (138 bar) gpm (lpm)	Max. Operating Pressure psi (bar)	Spray Angle	Orifice Material
DescaleJet® Pro	3.5 to 52 (14 to 196.8) 3.5 to 35 (14 to 140) for Mini DescaleJet Pro	5800 (400) 4350 (300) for Mini DescaleJet Pro	20° to 40° at 2175 psi (150 bar)	Tungsten carbide
26180/26190 and AA218/AA219	5.7 to 52 (21.6 to 196.8)	3000 (207)	15° to 40° at 40 psi (3 bar)	Tungsten carbide or hardened stainless steel
AA214 DescaleJet and Compact DescaleJet	1.4 to 10.6 (5.3 to 40.1)	5800 (400)	18° to 40° at 40 psi (3 bar)	Tungsten carbide
HiScaleJet and HSJ Nozzles	4.2 to 52 (15.9 to 196.8)	4350 (300)	23° to 40° at 2175 psi (150 bar)	Tungsten carbide
Mini HiScaleJet	4.2 to 52 (15.9 to 196.8)	5800 (400)	20° to 40° at 2175 psi (150 bar)	Tungsten carbide

PLACING YOUR ORDER

Call your local steel specialist for application assistance or to place an order.

FOR DETAILED NOZZLE PERFORMANCE DATA, SEE spray.com/steeltatalog/sectionC



OVERVIEW: VEEJET® NOZZLES

- Flat fan spray patterns available in different styles and a wide range of flow rates and spray angles
- Large coverage area per nozzle reduces the number of nozzles required
- Narrow spray angle nozzles provide focused impact for side sweep applications
- Self-aligning nozzles, ideal for use in headers or manifolds, use a dovetail groove or locating flats to ensure repeatable pattern positioning; available with weld or threaded body connection options
- Ideal for use in roll cooling and interstand cooling

VEEJET NOZZLE OPTIONS

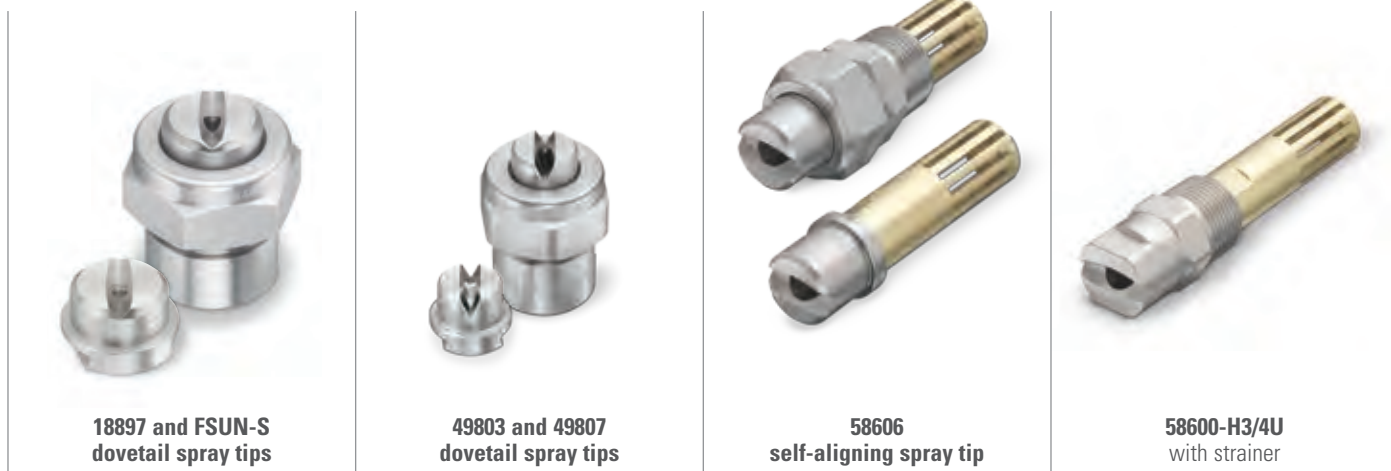

VEEJET NOZZLE QUICK REFERENCE GUIDE

Model	Connection/Type	Offset Angle	Flow Rate Range gpm (lpm)	Spray Angle	Materials
18897	Dovetail tip; threaded and weld body options	0°, 5°, 15°, 30°, 45° and 60°	1.0 to 44 (3.2 to 144)	15° to 110° at 40 psi (3 bar)	Brass, 303 stainless steel, hardened stainless steel, PVDF
FSUN-S	Dovetail tip; threaded and weld body options	0°, 5°, 15°	.06 to 109.7 (.2 to 353.6)	20° to 120° at 72 psi (5 bar)	Brass, 303 stainless steel, 316 stainless steel, PVDF
49803 and 49807	Dovetail tip; threaded and weld body options	5°	.05 to 13.6 (.22 to 50.5)	5° to 110° at 40 psi (3 bar)	Brass, 303 stainless steel, 316 stainless steel
58606	Self-aligning tip with locating flats; M body	15°	6.0 to 55.9 (34.2 to 180.2)	15° to 110° at 40 psi (3 bar)	303 stainless steel with brass strainer
58600	M	NA	7.1 to 141 (29 to 539)	50° to 95° at 40 psi (3 bar)	303 stainless steel with brass strainer

F = female thread; M = male thread.

PLACING YOUR ORDER

Call your local steel specialist for application assistance or to place an order.

FOR DETAILED NOZZLE PERFORMANCE DATA, SEE spray.com/steeltcatalog/sectionC

OVERVIEW: WASHJET® NOZZLES

- High-impact sprays and high pressure operation ensure optimal cleaning
- Made of 400 series stainless steel to provide longer wear life than traditional VeeJet® nozzles
- Flat spray nozzles provide an even edge fan type spray pattern
- Uniform spray distribution from .10 to 78 gpm (.39 to 290 lpm) by using optional internal guide vane to stabilize liquid turbulence
- Spray angles from 0° (solid stream) to 65° for MEG, WEG and MEG-SSTC; 5° to 80° for IMEG®
- Operating pressures from 300 to 4000 psi (20 to 275 bar)
- MEG-SSTC nozzles have tungsten carbide orifice inserts for maximum erosion resistance
- IMEG nozzles feature a patented design that minimizes turbulence and maximizes impact; higher impact per unit than MEG nozzles
- Ideal for light descaling of billets, blooms or rounds

WASHJET NOZZLE OPTIONS



WASHJET NOZZLE QUICK REFERENCE GUIDE

Model	Connection/Type	Connection Size (in.)	Materials
MEG	M	1/8 to 1/4	Hardened stainless steel
WEG	F	1/8 to 1/4	
MEG-SSTC	M	1/4	
IMEG	M	1/8 to 1/4	

F = female thread; M = male thread.

PLACING YOUR ORDER

Call your local steel specialist for application assistance or to place an order.

FOR DETAILED NOZZLE PERFORMANCE DATA, SEE spray.com/steeltatalog/sectionC

OVERVIEW:

FLOODJET® NOZZLES

- Wide angle, deflected type flat fan spray pattern – angles from 73° to 153°
- Uniform spray distribution from .04 to 110 gpm (.14 to 410 lpm)
- Use when nozzles can be mounted horizontally
- Can be used with steam for blow-off applications
- TEK provides a tapered edge spray pattern to eliminate heavy edges while maintaining the wide spray pattern
- Ideal for operations requiring wide coverage such as blowing loose scale off strip

FLATJET® NOZZLES

- Narrow angle, deflected type flat fan spray pattern – angles from 15° to 50°
- Uniform spray distribution from .24 to 39 gpm (.91 to 144 lpm)
- Provides higher impact than other narrow angle nozzles
- Ideal for side sweep

FLOODJET NOZZLE OPTIONS

FLATJET NOZZLE OPTIONS



FLOODJET & FLATJET NOZZLE QUICK REFERENCE GUIDE

Model	Connection/Type	Connection Size (in.)	Materials
K	M	1/8 to 1	Brass, 303 stainless steel, 316 stainless steel
TEK	M	1/8 to 1/4	Brass, 303 stainless steel
P	M	1/8 to 3/4	Brass, mild steel, 303 stainless steel, 316 stainless steel

F = female thread; M = male thread.

FloodJet nozzles are also available in quick-connect versions.

PLACING YOUR ORDER

Call your local steel specialist for application assistance or to place an order.

FOR DETAILED NOZZLE PERFORMANCE DATA, SEE spray.com/steeltcatalog/sectionC

OVERVIEW:

H FULLJET® NOZZLES

- Solid cone-shaped spray pattern with round impact area
- Unique vane design minimizes turbulence to ensure uniform spray distribution and consistent spray coverage
- Large unobstructed flow passages minimize clogging
- Flow rates from 5.1 to 3686 gpm (21 to 13953 lpm)
- Ideal for plate cooling

MAXIMUM FREE PASSAGE FULLJET NOZZLES

- Patented vane design provides largest free passage of maximum free passage nozzles; ideal for use with fluids containing particulates
- More uniform spray distribution than other large free passage nozzles
- Uniform spray distribution from 1.4 to 119 gpm (5.3 to 470 lpm)
- Operating pressures up to 80 psi (6 bar)
- Spray angles: 60°, 90° and 115°
- Ideal for cooling slab and strip

FULLJET NOZZLE OPTIONS



FULLJET NOZZLE QUICK REFERENCE GUIDE

Model	Connection/Type	Connection Size (in.)	Materials
H	F, Cast	1-1/4 to 8	Brass, 316 stainless steel
HMFP	F	3/8 to 1-1/2	316 stainless steel vane and choice of brass or 316 stainless steel bodies
	F	1-1/4 to 1-1/2	316 stainless steel vane and 316 stainless steel body
HHMFP	M	3/8 to 1	316 stainless steel vane and choice of brass or 316 stainless steel bodies
	M	1-1/4 to 1-1/2	316 stainless steel vane and 316 stainless steel body

F = female thread; M = male thread.

PLACING YOUR ORDER

Call your local steel specialist for application assistance or to place an order.

FOR DETAILED NOZZLE PERFORMANCE DATA, SEE spray.com/steeltatalog/sectionC

DESCALE HEADERS

OVERVIEW:

To ensure optimal descaling, we use DescaleWare®, our propriety software, for descale header layout. DescaleWare uses impact and coverage data collected in our spray laboratories to identify the nozzles and header layout that will provide the performance needed for your specific operation.

BENEFITS:

- Ensures headers are properly sized to match performance requirements
- Code compliance as required
- Single-source supply of headers and nozzles eliminates potential integration problems
- CFD modeling available to validate header design and reduce pressure loss and turbulence



This CFD model shows a 4" dia. header with 14 nozzles. The total flow is 743 gpm (2813 lpm) at 2300 psi (159 bar). The model reveals the velocity leading into the first six nozzles exceeds the recommended maximum of 15 ft/s (4.5 m/s). In fact, the entry velocity for the first nozzle is 25.7 ft/s (7.8 m/s).



This model shows what happens when the pipe dia. is increased to 6" and operating conditions remain the same. The entry velocity of the first nozzle is now well below the recommended value at 11.3 ft/s (3.4 m/s).

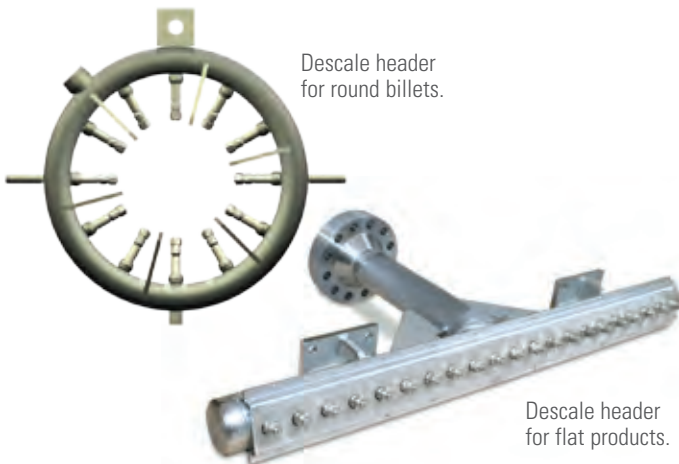

FOR MORE INFORMATION ON HEADER DESIGN AND SPECIFICATION GUIDELINES, SEE spray.com/steeltatalog/sectionC

LAMINAR FLOW HEADERS

OVERVIEW:

Laminar flow headers provide consistent and cost-effective sheet cooling on runout tables. Operating at pressures as low as 0.9 psi (0.06 bar), laminar cooling uses water very effectively.

BENEFITS:

- Rod-like column of water from solid stream VeeJet nozzles is superior to U-tube nozzle cooling
- Header does not need to be filled or drained to interrupt the flow pattern enabling simplified header sequencing and reduced lag time
- An internal baffle plate ensures precise flow distribution and simplifies maintenance and replacement
- Slit-style laminar flow headers that produce an evenly distributed curtain-like sheet of water help reduce cracking and other defects

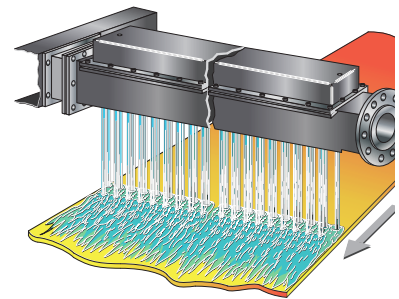

VEEJET® HEADERS

OVERVIEW:

Custom-designed headers equipped with VeeJet flat spray nozzles are ideal for cooling hot strip and plate products. Headers can be designed to allow use of VeeJet nozzles with different spray angles.

BENEFITS:

- Wide range of nozzle sizes, capacities, spray angles and materials
- Compact profile allows close positioning to target to maximize heat removal and extend roll life
- Overlapping patterns provide efficient, uniform cooling
- Suitable for use on runout tables, strip wash and lubrication





SOLUTIONS FOR COLD ROLLING MILLS

WASHING • RINSING • DRYING
OILING • ROLL COOLING
LUBRICATING • COATING



COLD ROLLING MILLS INTRODUCTION

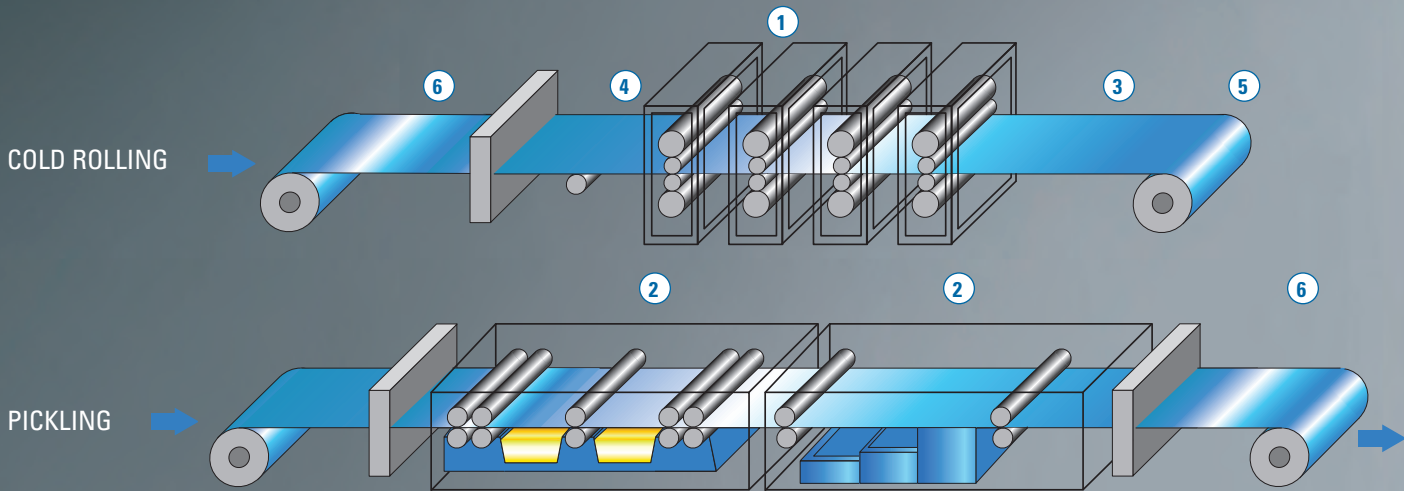

1 ROLL COOLING VeeJet® nozzles and headers	2 PICKLING AND RINSING PVDF VeeJet nozzles and headers	3 BLOW OFF AND DRYING WindJet® nozzles Air headers	4 LUBRICATION Automatic and air atomizing nozzles	5 OILING AccuOil™ system PulsaJet® nozzles VeeJet nozzles	6 WASHING AND RINSING FlatJet® nozzles FloodJet® nozzles VeeJet nozzles	7 DEGREASING AND QUENCHING VeeJet nozzles Brush headers
--	--	---	---	---	---	--

SPRAY TECHNOLOGY FOR ALL THE PROCESSES IN YOUR COLD ROLLING MILL

No matter what you need to wash, rinse, lubricate, cool or dry, Spraying Systems Co. has the ideal nozzle for your application. We offer hydraulic and air atomizing nozzles in a thousands of styles and sizes. Our VeeJet flat spray nozzles and headers are widely used in pickling, annealing and galvanizing operations and are available in acid- and corrosion-resistant plastics in addition to metal materials.

For oiling, zinc dip, galvanizing, soft quenching and more, consider our PulsaJet automatic spray nozzles. These unique nozzles provide superior spray performance and can help eliminate common quality problems. PulsaJet nozzles are part of our AccuOil system, which can dramatically reduce over-application of oil on strip, even when line speed changes. Our WindJet product line is ideal for drying and blow-off throughout your mill. Choose from headers and nozzles that use compressed air or air knife packages powered by energy-efficient regenerative blowers.

Contact your local steel specialist for a no-charge consultation to see how we can assist with process optimization and product selection.

**COLD ROLLING MILLS
TABLE OF CONTENTS**

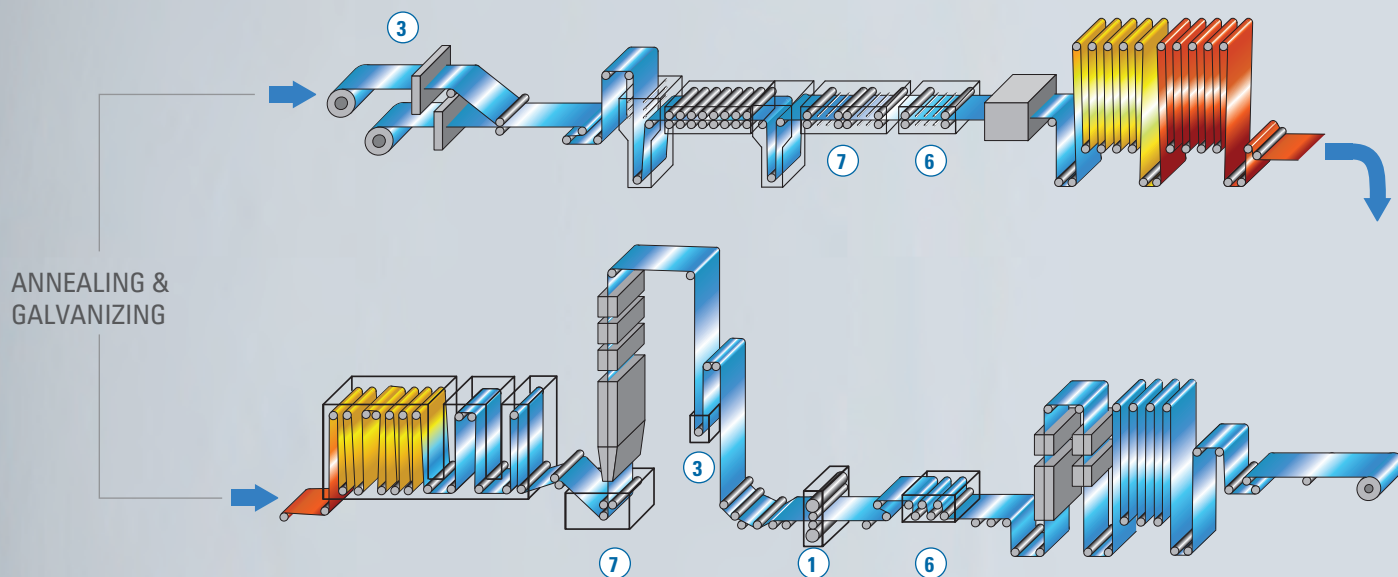

FLAT SPRAY NOZZLES

	OVERVIEW	PERFORMANCE	
	PAGE	ENGLISH	METRIC
H-DT, H-DU, H-U, H-VV, H-VVL and U VeeJet® nozzles	D4 ▶	G20-23 ▶	G86-89 ▶
18897, FSUN-S and 20799 dovetail spray tips	D5 ▶	G41 ▶	G107 ▶
TPU, 13802 and 14784 UniJet® spray tips	D6 ▶	G34 ▶	G100 ▶
Flat spray headers	D6 ▶	CONTACT LOCAL STEEL SPECIALIST ▶	

AUTOMATIC AND AIR ATOMIZING NOZZLES

Electrically-actuated PulsaJet® hydraulic automatic nozzles	D7 ▶	Cat76 ▶	Cat76-M ▶
Electrically-actuated PulsaJet air atomizing automatic nozzles	D8 ▶	Cat76 ▶	Cat76-M ▶
Air-actuated JAU series automatic air atomizing nozzles	D9 ▶	Cat76 ▶	Cat76-M ▶
Air-actuated J series air atomizing nozzles	D10 ▶	Cat76 ▶	Cat76-M ▶
Automatic and air atomizing spray headers	D10 ▶	CONTACT LOCAL STEEL SPECIALIST ▶	

**MORE FULL CONE NOZZLES:
SEE SECTIONS B AND C**

BLOWER AND COMPRESSED AIR PRODUCTS

WINDJET® AIR KNIFE PACKAGES

	OVERVIEW	PERFORMANCE	
	PAGE	ENGLISH	METRIC
Air knives and blowers	D11 ▶	Cat20D ▶	Cat20D ▶

WINDJET COMPRESSED AIR PRODUCTS

AA727, AA707 and Y767 nozzles	D12 ▶	Cat20D ▶	Cat20D ▶
WindJet low flow air knives	D12 ▶	Cat20D ▶	Cat20D ▶
WindJet air amplifiers	D12 ▶	Cat20D ▶	Cat20D ▶
UniJet air nozzles	D12 ▶	Cat20D ▶	Cat20D ▶
LU-VK air nozzles	D12 ▶	CONTACT LOCAL STEEL SPECIALIST ▶	
Air nozzle headers	D12 ▶	CONTACT LOCAL STEEL SPECIALIST ▶	

SYSTEMS AND HEADERS

AccuOil™ system	D13 ▶	CONTACT LOCAL STEEL SPECIALIST ▶	
Brushless, brush and automatic brush headers	D14 ▶	CONTACT LOCAL STEEL SPECIALIST ▶	
Slit laminar flow headers	D14 ▶	CONTACT LOCAL STEEL SPECIALIST ▶	

**MORE FLAT SPRAY NOZZLES:
SEE SECTIONS B AND C**



OVERVIEW: VEEJET® NOZZLES

- Flat spray nozzles are ideal for use in spray headers or manifolds, producing a fan-type, tapered-edge spray pattern to ensure even coverage when multiple nozzles are used in a series
- One-piece design
- Spray angles from 0° to 110°
- Uniform spray distribution with flow rates from .012 to 1237 gpm (.047 to 4720 lpm)
- Operating pressures up to 500 psi (35 bar)
- Ideal for use in pickling, annealing, galvanizing and rolling operations

VEEJET NOZZLE OPTIONS



H-VV and H-VVL

1/8" to 1/4" male conn.
Flow rates below 1 gpm at 40 psi (3.8 lpm at 2.8 bar)
H-VVL includes integral strainer



H-DT

1/8" to 1/4" female conn.
Flow rates below 1 gpm at 40 psi (3.8 lpm at 2.8 bar)



H-DU

1/8" to 1/4" female conn.
Flow rates of 1 gpm and greater at 40 psi (3.8 lpm and greater at 2.8 bar)



U

1" to 2" male conn.
Flow rates of 40 gpm and greater at 40 psi (151 lpm and greater at 2.8 bar)



H-U

1/8" to 3/4" male conn.
Flow rates of 1 gpm and greater at 40 psi (3.8 lpm and greater at 2.8 bar)

VEEJET NOZZLE QUICK REFERENCE GUIDE

Model	Connection/Type	Connection Size (in.)	Materials
H-VV	M	1/8 to 1/4	Brass, mild steel, 303 stainless steel, 316 stainless steel, PVDF
H-VVL	M	1/8 to 1/4	Brass, 303 stainless steel, 316 stainless steel
H-DT	F	1/8 to 1/4	Brass, 303 stainless steel
H-DU	F	1/8 to 1/4	Brass, 303 stainless steel, polyvinyl chloride
U	M	1 to 2	Brass, mild steel, 303 stainless steel
H-U	M	1/8 to 3/4	Brass, mild steel, 303 stainless steel, 316 stainless steel, polyvinyl chloride, PVDF

F = female thread; M = male thread.

PLACING YOUR ORDER

Call your local steel specialist for application assistance or to place an order.

FOR DETAILED NOZZLE PERFORMANCE DATA, SEE spray.com/steeltcatalog/sectionD



OVERVIEW: DOVETAIL SPRAY TIPS

- Flat fan spray pattern; widely use in spray headers
- Dovetail groove feature provides repeatable pattern positioning without an elastomeric seal
- Self-aligning, interchangeable spray tip slides into the groove in the nozzle body ensuring exact alignment every time the nozzle is reassembled
- Ideal for use in pickling, annealing, galvanizing and rolling operations

DOVETAIL SPRAY TIP OPTIONS



18897 and FSUN-S
dovetail spray tips



20799
dovetail spray tip

DOVETAIL SPRAY TIP QUICK REFERENCE GUIDE

Model	Connection/Type	Offset Angle	Flow Rate gpm (lpm)	Spray Angle	Materials
18897	Dovetail tip; threaded and weld body options	0°, 5°, 15°, 30°, 45° and 60°	1.0 to 44 (3.2 to 144)	15° to 110° at 40 psi (3 bar)	Brass, 303 stainless steel, hardened stainless steel, PVDF
FSUN-S	Dovetail tip; threaded and weld body options	0°, 5°, 15°	.06 to 109.7 (.2 to 353.6)	20° to 120° at 72 psi (5 bar)	Brass, 303 stainless steel, 316 stainless steel, PVDF
20799	Dovetail tip; threaded and weld body options	15°	.63 to 45 (2.0 to 144)	120° at 40 psi (3 bar)	Brass, stainless steel, hardened stainless steel

PLACING YOUR ORDER

Call your local steel specialist for application assistance or to place an order.

FOR DETAILED NOZZLE PERFORMANCE DATA, SEE spray.com/steeltatalog/sectionD



OVERVIEW: UNIJET® NOZZLES

- UniJet quick-connect nozzles reduce maintenance time – bodies remain on pipe/header
- Save on nozzle replacement costs – bodies can be reused, only spray tips are replaced; tips fit on male or female bodies
- Produce a uniform distribution at flow rates up to 7 gpm (28 lpm) at 40 psi (2.8 bar); spray angles available from 15° to 110°
- Ideal for use in pickling, annealing, galvanizing and rolling operations

UNIJET NOZZLE OPTIONS



TPU spray tip



13802 spray tip

Self-aligning tip with wrench flats on top of tip; straight alignment flats connection



14784 spray tip

Self-aligning tip

UNIJET NOZZLE QUICK REFERENCE GUIDE

Model	Connection/Type	Materials
TPU	T male and TT female body options	Brass, 303 stainless steel
13802	T male and TT female body options	
14784	M	

F = female thread; M = male thread.

PVDF AND PVC VEEJET® HEADERS

OVERVIEW:

VeeJet nozzles are available in PVDF and PVC for operations such as pickling lines that require an acid wash. Built-to-order spray headers are also available in PVC and PVDF for corrosion-resistance. Plastic headers can be reinforced with steel to prevent sagging.



PLACING YOUR ORDER

Call your local steel specialist for application assistance or to place an order.

FOR DETAILED NOZZLE PERFORMANCE DATA, SEE spray.com/steeltcatalog/sectionD



OVERVIEW: ELECTRICALLY-ACTUATED PULSAJET® HYDRAULIC AND AIR ATOMIZING NOZZLES

- Hydraulic atomizing PulsaJet nozzles use only liquid pressure as the force for atomization; air atomizing PulsaJet nozzles use liquid mixed with compressed air as the atomization force
- Dozens of UniJet® spray tips and air atomizing spray set-ups are available for PulsaJet nozzles in a wide variety of flow rates and spray patterns
- When using a PulsaJet series nozzle and an AutoJet® spray controller, Precision Spray Control (PSC) is achieved:
 - Consistent application rates at varying line speeds
 - Low flow rates comparable to air atomizing nozzles for possible elimination of compressed air in some operations
- Ideal for oiling, zinc dip, galvanizing, soft quenching and more

ELECTRICALLY-ACTUATED PULSAJET HYDRAULIC NOZZLE OPTIONS



AA10000AUH-03
 Typical flow range:
 0.0017 - 0.47 gpm (0.006 - 1.8 lpm)
 Stainless steel, Viton® or EPDM seals, PPS and PEEK
 Up to 15,000 cycles per min
 Zone 1 use version also available



AA10000AUH-10
 Typical flow range:
 0.02 - 1.6 gpm (0.075 - 6.1 lpm)
 Stainless steel, Viton or EPDM seals, PPS and PEEK
 Up to 5,000 cycles per min



AA10000AUH-104210
 Rear liquid inlet
 Typical flow range:
 0.0017 - 0.47 gpm (0.006 - 1.8 lpm)
 Stainless steel, Viton or EPDM seals, PPS and PEEK
 Up to 15,000 cycles per min
 Side liquid inlet version for low profile mounting also available



AA10000AUH-104215
 Front port for liquid recirculation
 Typical flow range:
 0.0017 - 0.47 gpm (0.006 - 1.8 lpm)
 Stainless steel, Viton or EPDM seals, PPS and PEEK
 Up to 15,000 cycles per min



AA10000AUH-72440-1/4
 Jacketed design keeps nozzle and sprayed liquid at a consistent temperature
 Typical flow range:
 0.0017 - 0.47 gpm (0.006 - 1.8 lpm)
 Electropolished or chromium nitride coated magnetic stainless steel, stainless steel, Viton or EPDM seals, PPS and PEEK
 Up to 15,000 cycles per min



AA10000AUH-0050
 Miniature design for applications with limited space
 Typical flow range:
 0.0009 - 0.08 gpm (0.003 - 0.30 lpm)
 Stainless steel, Viton or EPDM seals, PPS and PEEK Available only as a part of the PulsaJet Mini Low Flow Spray System (with AutoJet spray controller)

PLACING YOUR ORDER

Call your local steel specialist for application assistance or to place an order.

FOR DETAILED NOZZLE PERFORMANCE DATA, SEE spray.com/steeltatalog/sectionD



ELECTRICALLY-ACTUATED PULSAJET® AIR ATOMIZING NOZZLE OPTIONS



AA10000JJAU

Flow rates up to 0.16 gpm (0.61 lpm)
Stainless steel, PPS and PEEK construction with Viton® or EPDM seals
Up to 10,000 cycles per min



AA10000JAU-10

Flow rates up to 0.75 gpm (2.84 lpm)
Stainless steel, PPS and PEEK construction with Viton or EPDM seals
Up to 5,000 cycles per min

ELECTRICALLY-ACTUATED PULSAJET HYDRAULIC NOZZLE QUICK REFERENCE GUIDE

Model	Connection Size (in.)	Max Liquid Pressure psi (bar)	Power VDC (Amp)	Max Flow gpm (lpm)	Max Temp Liquid °F (°C)	Max Speed cpm	Spray Tips
AA10000AUH-03	1/8	100 (7)* 250 (17) (250 w/ AutoJet® 2008+ spray controller)	24 (0.36)	0.47 (1.8)	200 (93)	10,000 (15,000 with AutoJet 2008+ controller)	TPU
AA10000AUH-10	1/8	100 (7)	24 (1.05)	1.6 (6.1)	150 (66)	5,000	TPU
AA10000AUH-104210	1/8	100 (7)	24 (0.36)	0.47 (1.8)	200 (93)	10,000 (15,000 with AutoJet 2008+ controller)	PWMD w/ auto spray pattern alignment
AA10000AUH-104215	1/8	100 (7)	24 (0.36)	0.47 (1.8)	200 (93)	10,000 (15,000 with AutoJet 2008+ controller)	PWMD w/ auto spray pattern alignment
AA10000AUH-72440-1/4	1/4	100 (7)* 250 (17) (250 w/ AutoJet 2008+ spray controller)	48 (0.36)	0.47 (1.8)	150 (66)	10,000 (15,000 with AutoJet 2008+ controller)	TPU
AA10000AUH-0050	5/32 (4mm) tube fittings	200 (14)	48 (1.0)	0.08 (0.30)	150 (66)	25,000	PWMD w/ auto spray alignment pattern

*Higher pressure possible with AutoJet 2008+ spray controller.

ELECTRICALLY-ACTUATED PULSAJET AIR ATOMIZING NOZZLE QUICK REFERENCE GUIDE

Model	Connection Size (in.)	Max Liquid Pressure psi (bar)	Power VDC (Amp)	Max Air Pressure psi (bar)	Max Flow gpm (lpm)	Max Temp Liquid °F (°C)	Max Speed cpm	Spray Set-Ups
AA10000JJAU	1/8 (air and liquid)	100 (7) 250 (17) (w/ AutoJet 2008+ spray controller)	24 (0.36)	100 (7)	0.16 (0.61)	200 (93)	10,000	JJ set-ups
AA10000JAU-10	1/8 (air and liquid)	100 (7)	24 (1.05)	100 (7)	0.75 (2.84)	200 (93)	5000	Threadless 1/4J set-ups



OVERVIEW: AIR-ACTUATED AUTOMATIC AIR ATOMIZING NOZZLES

- Compressed air is used to control air cylinder operation for accurate intermittent spraying (up to 180 cycles per minute) and also for liquid atomization
- Wide variety of nozzle bodies is available for convenient mounting and positioning
- Models available with clean-out needles, shut-off needles, swivels and strainers to optimize performance
- Liquid lines can be pressure-fed, siphon-fed or gravity-fed
- Spray set-ups consisting of an air cap and a fluid cap can mix the fluids either internally or externally to produce a fine spray pattern
- Dozens of Drip Free™ air atomizing spray set-ups available for a wide range of flow capacity and spray patterns
- Ideal for zinc dip, galvanizing, soft quenching and more

AIR-ACTUATED AUTOMATIC AIR ATOMIZING NOZZLE OPTIONS



1/4JAU

Flow rates up to 1.2 gpm (4.5 lpm)
Drip Free spray set-ups provide complete shut-off
Nickel-plated brass or stainless steel



10535-1/4J

Self-contained air cylinder provides controlled intermittent spraying
Drip Free spray set-ups provide complete shut-off
Nickel-plated brass or stainless steel



D55500-JAU

Block design 30% smaller than standard 1/4JAU
Drip Free spray set-ups provide complete shut-off
Stainless steel

AIR-ACTUATED AUTOMATIC AIR ATOMIZING NOZZLE QUICK REFERENCE GUIDE

Model	Connection Size (in.)	Max Liquid Pressure psi (bar)	Min Air Cylinder Pressure psi (bar)	Max Flow gpm (lpm)	Max Temp Liquid °F (°C)	Max Speed cpm	Spray Set-Ups
1/4JAU	1/4 (air and liquid)	125 (8.6)	30 (2.1)	1.2 (4.5)	400 (204)	180	1/4J set-ups
10535-1/4J	1/4 (air and liquid)	125 (8.6)	30 (2.1)	1.2 (4.5)	400 (204) liquid 150 (66) air	180	1/4J set-ups
D55500-JAU	1/8 (air and liquid)	43 (3)	72 (5)	0.42 (1.6)	158 (70)	600	1/4J or DSU set-ups



OVERVIEW: J AND JJ SERIES AIR ATOMIZING NOZZLES

- Liquid and compressed air enter the nozzle body and are mixed by the spray set-up to produce a finely atomized spray pattern
- Spray set-ups, consisting of an air cap and a fluid cap, can mix the fluids either internally or externally
- Hundreds of spray set-ups are available to produce cone and flat spray patterns
- A wide variety of nozzle bodies are available for convenient mounting and positioning
- JJ compact nozzle bodies are available for applications where space is limited
- Models available with clean-out needles, shut-off needles swivels and strainers to optimize performance
- Ideal for zinc dip, galvanizing, soft quenching and more

J AND JJ SERIES AIR ATOMIZING NOZZLE OPTIONS



1/8J and 1/4J nozzles

Flow rates up to 72 gph (273 lph)
Liquid and air inlets on opposing sides
Removable plug so needle assemblies can be added
Nickel-plated brass or stainless steel



1/8JJ series nozzles

Compact version of 1/4J
Flow rates up to 33 gph (126 lph) in various spray patterns
Liquid and air inlets on opposing sides
Removable plug so needle assemblies can be added
Nickel-plated brass or stainless steel

AIR ATOMIZING NOZZLE QUICK REFERENCE GUIDE

Model	Connection Size (in.)	Max Flow gph (lph)	Max Temp Liquid °F (°C)	Spray Set-Ups
1/8J and 1/4J	1/8 to 1/4	72 (273)	400 (204)	1/8J and 1/4J set-ups
1/8JJ	1/8	33.2 (126)	400 (204)	1/8JJ set-ups

AUTOMATIC AND AIR ATOMIZING NOZZLE HEADERS

OVERVIEW:

Headers equipped with automatic hydraulic or air atomizing nozzles are ideal for applications requiring zone control. A PLC equipped with AutoJet® precision spray control drivers automatically adjust sprays as needed to accommodate multiple strip widths. For air atomizing nozzles, options include block-style and standard headers.

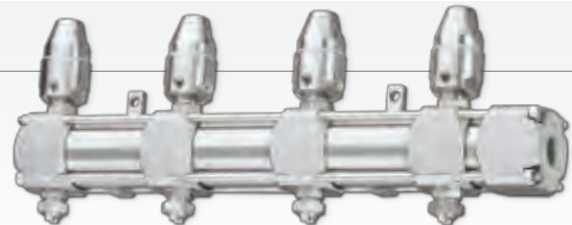

Block manifold



63600 manifold

WINDJET® AIR KNIFE PACKAGES

OVERVIEW:

- Powered by a rugged, regenerative blower; no compressed air required. Costs can be reduced by 95% or more
- A uniform high volume, constant heated air stream is produced along the entire edge of the knife eliminating spotting problems
- Low operating noise
- Large application area
- Packages are customized based on application
- Use when velocity is needed or the oil in compressed air is causing quality problems
- Knife lengths of 6", 12", 18", 24", 30" and 36" (152, 305, 457, 610, 762 and 914 mm)
- Air slot sizes of .040" and .060" (1 and 1.5 mm)
- Aluminum and 316 stainless steel material options
- Blower assemblies: 5.5, 10, 20, 25 and 30 Hp (4.1, 7.5, 14.9, 18.6, 22.3 kW). Include pressure relief valve, pressure gauge, air inlet filter, filter monitoring gauge, fittings, mounting adapter for flexible or rigid tubing
- Ideal for drying cut sheet and rolls and debris removal



Regenerative blower assemblies available in wide range of horsepower and air knife lengths

PLACING YOUR ORDER

Call your local steel specialist for application assistance or to place an order.

FOR DETAILED NOZZLE PERFORMANCE DATA, SEE spray.com/steeltcatalog/sectionD

WINDJET® COMPRESSED AIR NOZZLES

OVERVIEW:

- Economical alternative to drilled pipe
 - Air nozzles use compressed air use 25% to 35% less air than open pipe
 - Low flow air knives use 89% to 92% less air than open pipe
 - Air amplifiers use 75% to 90% less air than open pipe
- Perceived noise reductions ranging from 28% to 60% less than open pipe
- Improved worker safety
- AA727 nozzles produce controlled flat fan air pattern for uniform distribution
- AA707 nozzles produce tightly directed round spray pattern and feature color-coded aluminum caps for easy flow rate identification
- Y767 nozzles feature a short profile – less than half the height of the AA727
- Ideal for drying cut sheet and rolls and debris removal



AA727 WindJet nozzles
1/4" male or female conn.
Polyphenylene sulfide, aluminum, ABS plastic or 303 stainless steel



AA707 WindJet nozzles
1/4" male conn.
Polyphenylene sulfide, PVDF, aluminum, ABS plastic or 303 stainless steel



Y767 Compact WindJet Nozzles
1/4" male conn.
ABS plastic or 303 stainless steel

WINDJET COMPRESSED AIR LOW FLOW AIR KNIVES AND AIR AMPLIFIERS

OVERVIEW:

- Low flow air knives provide a uniform, high velocity air flow across the entire length of the knife with no temperature increase
- Air amplifiers deliver a targeted high-volume, high velocity amplified air stream



WindJet low flow air knives
3", 6", 12", 18" and 24"
(8, 15, 30, 46 and 61 cm) lengths
Aluminum or 316 stainless steel
Shim sets available to adjust air force and flow

WindJet air amplifiers
1/8" to 1/2" female conn.
Aluminum and 316 stainless steel material options

UNIJET® AIR NOZZLES

OVERVIEW:

- Blow-off spray tips specifically designed for use with air and steam to deliver a wide, uniform spray



UniJet blow-off nozzle
1/8" to 3/8" conn.
Brass or 303 stainless steel

LU-VK AIR NOZZLES

OVERVIEW:

- Round high-performance, multi-orifice air nozzle
- One-piece, compact design is well-suited for use in confined areas



LU-VK air nozzle
1/2" to 3/4" female conn.
Brass or 303 stainless steel

AIR NOZZLE HEADERS

OVERVIEW:

WindJet air nozzles can be mounted on a header to ensure uniform coverage of the target area. Standard manifolds are available with 4 to 30 nozzles. Impact can be increased from moderate to very high with a simple operating pressure adjustment.



ACCUOIL™ SYSTEM

OVERVIEW:

The AccuOil system enables precise, uniform application of oil on strip and reduces waste and quality problems. The system uses Precision Spray Control (PSC) to ensure the proper volume of oil is applied consistently, even when line speed changes and sheet width varies. Electrically-actuated hydraulic PulsaJet® nozzles mounted on headers and are controlled by a PLC equipped with AutoJet® PSC drivers. The need for compressed air is eliminated and only the nozzles required to cover the strip width are activated to spray, eliminating oil waste and hazardous overspray.

BENEFITS:

- Reduced scrap – uniform coverage across the entire strip eliminates scrap and costly rework
- Consistent application even when line speed changes
- Lower operating costs – reduces oil consumption, eliminates compressed air
- Reduced maintenance time – reduces messy, dangerous oil to remove from equipment and floors
- Flexible configurations – choose from heated versions with recirculating header and non-heated systems with standard header. Both versions are available with one or two channels
- Ideal for cold and temper mills

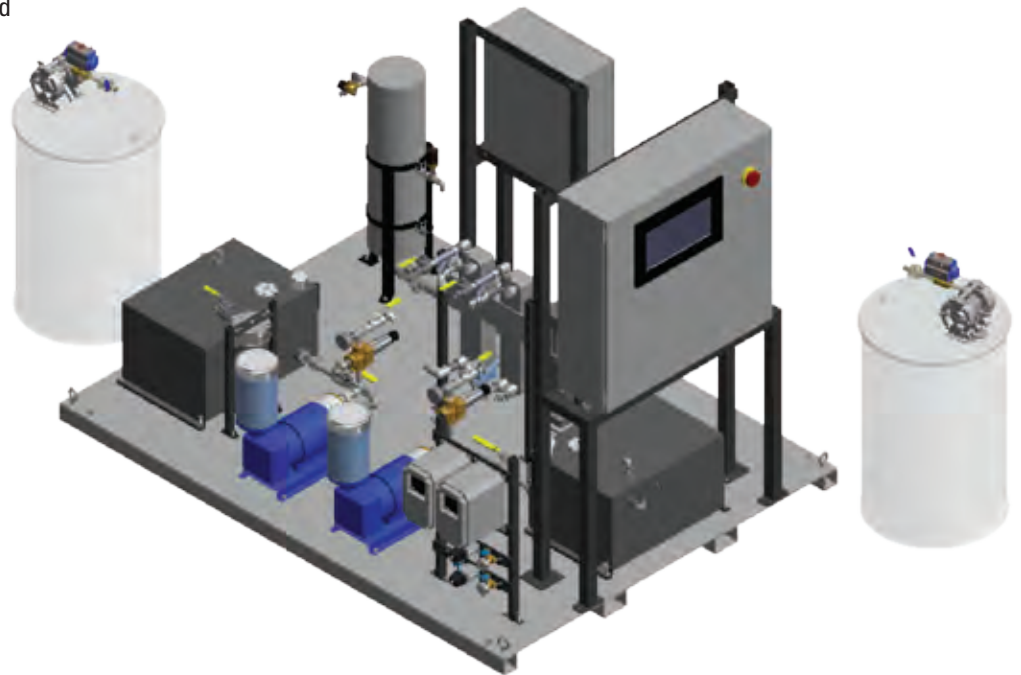

PLACING YOUR ORDER

Call your local steel specialist for application assistance or to place an order.

FOR DETAILED SYSTEM DATA, SEE spray.com/steeltatalog/sectionD



SPRAY HEADERS

OVERVIEW:

Spray headers are available for a wide range of operations including cooling, cleaning strip before galvanizing and high-pressure rinsing in pickling operations. Headers are built-to-order to optimize nozzle performance and easily integrate into existing lines.

BENEFITS:

Brushless headers

- Basic, effective and economical
- For use with fresh water and operations where nozzle clogging is unlikely
- Use with self-cleaning nozzles when brushes are not desirable
- Available in PVDF and stainless steel

Brush headers

- An internal rotating brush assembly sweeps debris away from nozzles without shutting the system down
- Brushes scrub the interior wall of the header as well as the nozzle orifices, removing accumulated debris in a matter of seconds
- Debris is discharged through a flush-out valve
- Manually-operated brush headers use a handwheel for brush rotation
- Automatic spray headers are equipped with geared drive unit, smart motor and optional timer control

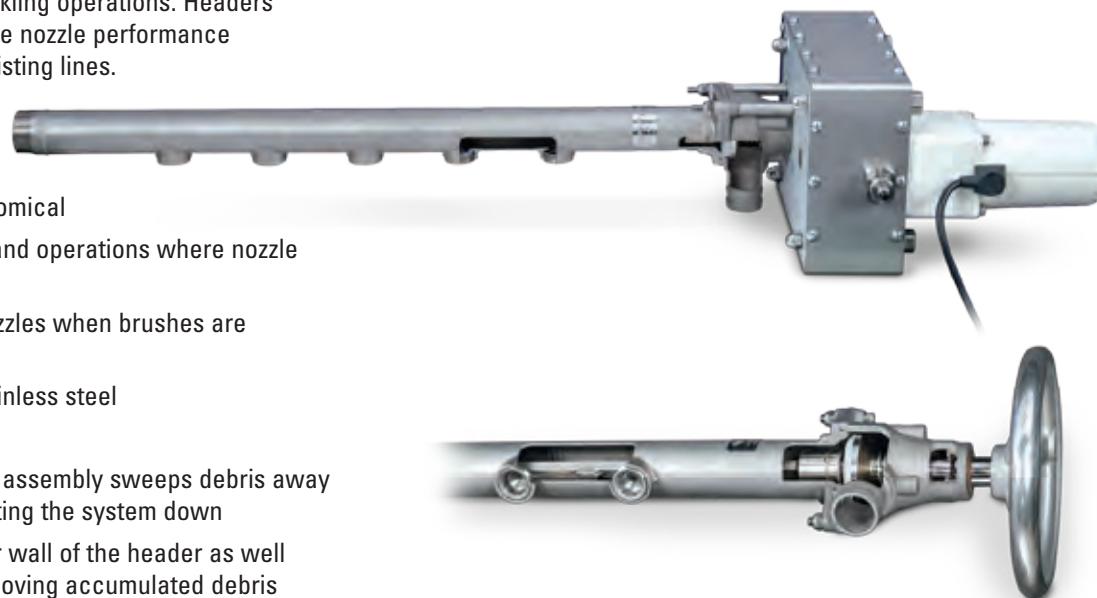

SLIT LAMINAR FLOW HEADERS

OVERVIEW:

The ultra-thin, uniform, continuous sheet of water or air produced by our laminar flow headers improves cleaning and drying in a wide range of operations and provides operating flexibility.

BENEFITS:

- Vertical sheet of liquid or air can be sprayed upward or downward
- Slit widths from .004" to .06" (.1 to 1.6 mm)
- Lengths from 2" to 118" (50 to 3000 mm)
- Flow rate range: 2 to 350 gpm (8.5 to 1325 lpm)
- Dual function operation works with both water and air, eliminating the need for two separate systems
- 304 or 316 stainless steel, PVC or CPVC



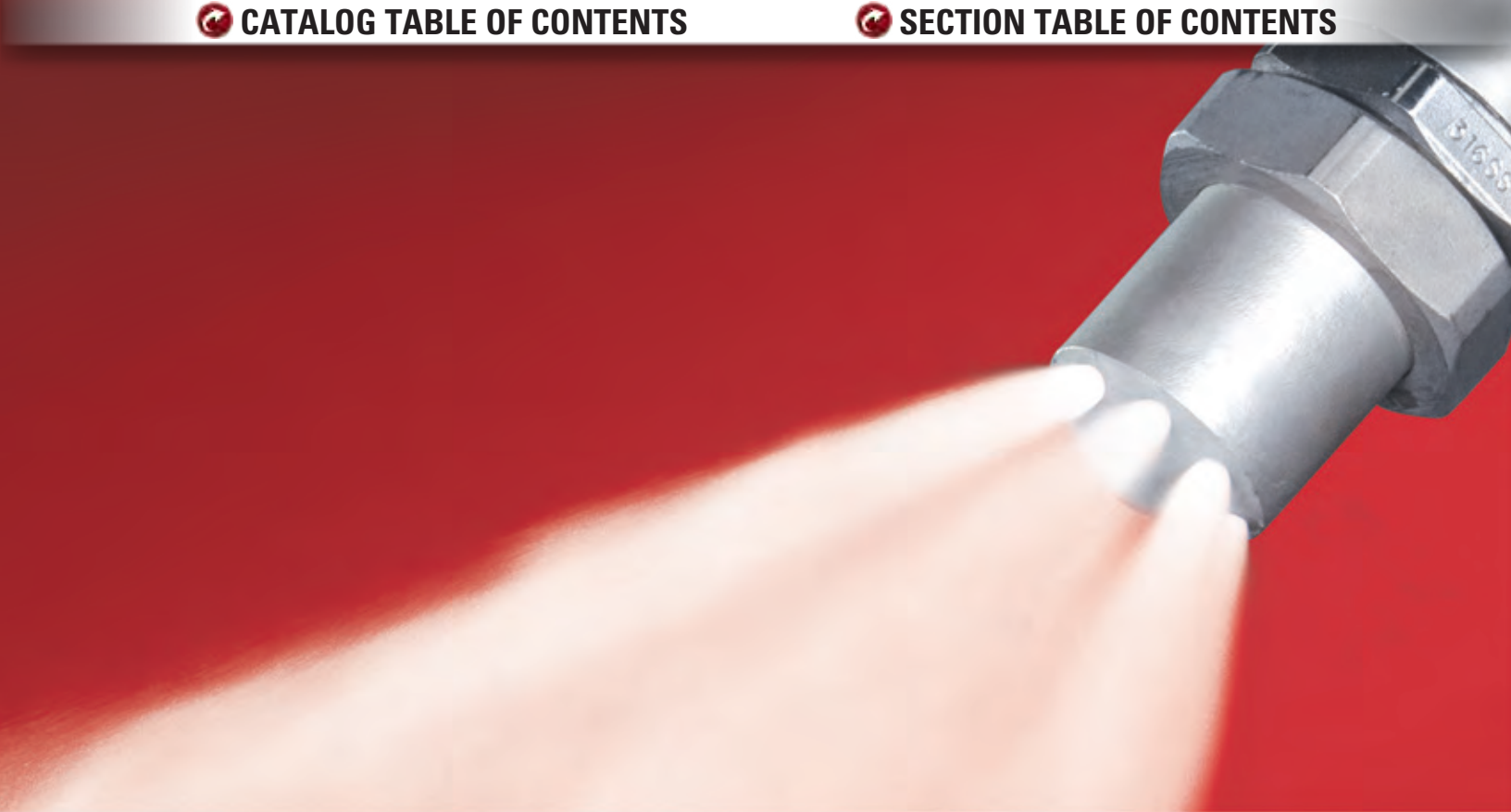

SOLUTIONS FOR IRON AND STEELMAKING

GAS COOLING • DUST SUPPRESSION
SINTER COOLING • FIRE CONTROL
COATING • ELECTRODE COOLING
COKE COOLING



IRON AND STEELMAKING
INTRODUCTION

STOCKPILE

IRON PRODUCTION

FURNACE

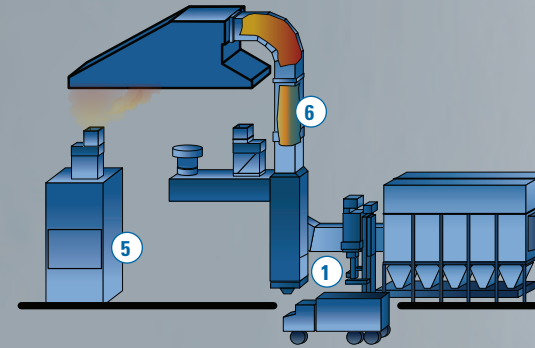
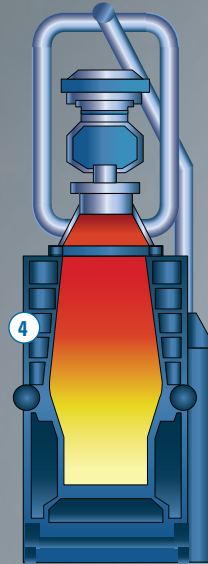
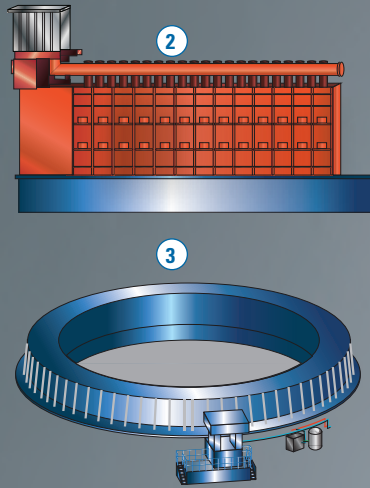

1

DUST CONTROL

- FullJet® nozzles
- UniJet® nozzles
- Air atomizing nozzles

2

COKE COOLING

- FullJet nozzles

3

SINTER COOLING

- FullJet nozzles
- FloMax® nozzles
- Spray lances

4

BLAST FURNACE COOLING

- Air atomizing nozzles

PRODUCT SOLUTIONS AND THE EXPERTISE TO ACHIEVE SUPERIOR PERFORMANCE

We have a full range of nozzles and systems for your iron and steelmaking requirements. Just as importantly, we have the services and test equipment to help optimize performance in critical operations such as sinter, coke, electrode and gas cooling and more.

In order to accurately predict performance in a customer's environment, we often use Computational Fluid Dynamics (CFD) modeling. Common uses for CFD include the determination of the best drop size for gas cooling and conditioning and the ideal placement of nozzles and lances in the furnace, cooling tower or other process vessel.

In dust suppression and fire control applications, we often head to our state-of-the-art test laboratories. Drop velocity and distribution studies conducted in our wind tunnel are widely used to simulate the conditions where the nozzles will be used to verify the expected performance can be achieved.



**IRON AND STEELMAKING
TABLE OF CONTENTS**

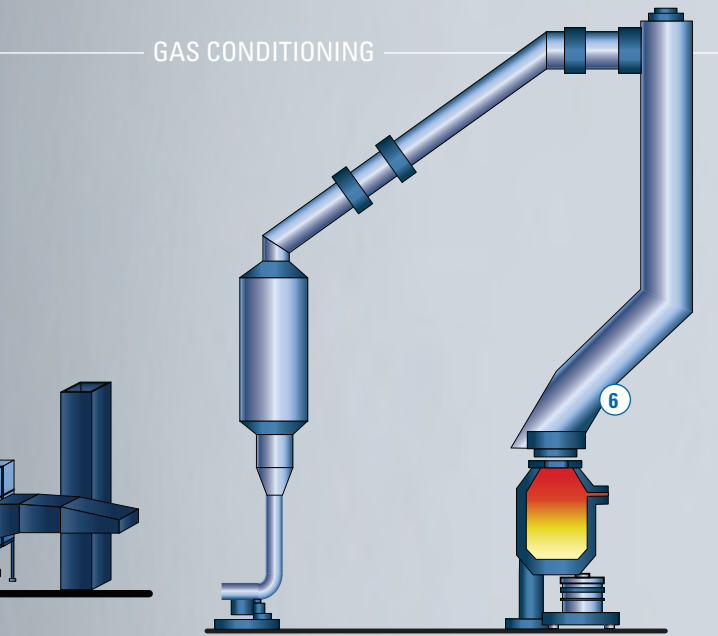

5

ELECTRODE COOLING

- VeeJet® nozzles
- Air atomizing nozzles
- FlatJet® nozzles

6

GAS COOLING

- AutoJet Gas Cooling Systems
- FloMax nozzles
- FullJet nozzles
- WhirlJet nozzles
- Spray lances

MORE INFORMATION ON OUR MODELING AND TESTING SERVICES CAN BE FOUND IN SECTION A.

YOUR LOCAL STEEL SPECIALIST CAN ALSO PROVIDE ADDITIONAL INFORMATION ABOUT HOW WE CAN ASSIST WITH PROCESS OPTIMIZATION.

AIR ATOMIZING NOZZLES

FloMax® nozzles

J series nozzles

OVERVIEW PAGE	PERFORMANCE	
	ENGLISH	METRIC
E4 ▶	CONTACT LOCAL STEEL SPECIALIST ▶	
E5 ▶	CONTACT LOCAL STEEL SPECIALIST ▶	

FULL CONE NOZZLES

H, HF, R, RF, RR, HMFP and HHMFP FullJet® nozzles

HHSJ and HHSJX SpiralJet® nozzles

TG and TG-SQ UniJet® spray tips

E6 ▶	G48 ▶	G114 ▶
E7 ▶	G54-55 ▶	G120-121 ▶
E8 ▶	G61 ▶	G127 ▶

HOLLOW CONE NOZZLES

AX, BX, CX, CF, E, and BD WhirlJet® nozzles

BSJ SpiralJet nozzles

E9 ▶	G63-68 ▶	G129-134 ▶
E11 ▶	G69 ▶	G135 ▶

SYSTEMS

AutoJet® Gas Cooling Systems and lances

E12 ▶	CONTACT LOCAL STEEL SPECIALIST ▶
-------	----------------------------------

**MORE FULL CONE NOZZLES:
SEE SECTIONS B AND C**



OVERVIEW: FLOMAX® NOZZLES

- Patented multi-stage atomization process produces very small drops using less compressed air than other nozzles
- High turndown ratio for maximum operating flexibility
- Large free passages reduce the risk of clogging and enable the use of lower quality water sources
- Anti-bearding nozzles feature a patented air cap design that resists material buildup near nozzle orifices and prevents performance problems
- Standard and made-to-order lances are also available in a wide range of materials and configurations
- Ideal for evaporative gas cooling and sinter cooling

FLOMAX NOZZLE OPTIONS



FLOMAX NOZZLE QUICK REFERENCE GUIDE

Model	Flow Rate Range gpm (lpm)	Spray Angle	Materials
FM3A and FM3A-AB*	.03 to 3.0 (1.13 to 11.3)	20° and 55°	316 or 310 stainless steel, Hastelloy®; cap options for anti-bearding versions include reaction-bonded silicon carbide, Stellite®, ceramic and tungsten carbide
FM5A and FM5A-AB*	.7 to 7.0 (2.6 to 26.5)	20° and 55° (95° optional)	
FM10A and FM10A-AB*	1.3 to 13.0 (4.9 to 49.2)	20° and 55° (95° optional)	
FM25A and FM25A-AB*	10.0 to 30.0 (37.8 to 114)	20° and 55° (95° optional)	
FM40A and FM40-ABD	20.0 to 45.0 (75.7 to 170.3)	55° and 95°	316 or 310 stainless steel, Hastelloy
FMX015	.03 to .25 (.11 to .94)	20°	
FMX030	.05 to .5 (.19 to 1.89)	20°	
FMX090	.5 to 1.5 (.11 to .94)	20° and 55°	

* Anti-bearding versions not available in 20° spray angle.

PLACING YOUR ORDER

Call your local steel specialist for application assistance or to place an order.



OVERVIEW: J SERIES NOZZLES

- J Series nozzles consist of a nozzle body and spray set-up
- Standard bodies have liquid and air inlets on opposing sides of the nozzle bodies. Nozzle bodies include a removable plug so needle assemblies can be added in the future. Additional body styles available for 1/2J
- 1/2J nozzles are available with a variety of spray set-ups and flow rates up to 306 gph (1158 lph) in various spray patterns
- 1J nozzles are also available with several spray set-ups and flow rates up to 29 gpm (110 lpm) in various spray patterns
- Ideal for dust suppression and some gas cooling operations

J SERIES NOZZLE OPTIONS



J SERIES NOZZLE QUICK REFERENCE GUIDE

Model	Connection/Type	Inlet Connection Size (in.)	Max Temp Liquid °F (°C)	Materials
1/2J	F	1/2	400 (204)	Nickel-plated brass or stainless steel construction
1J	F	1	400 (204)	

F = female thread; M = male thread.

PLACING YOUR ORDER

Call your local steel specialist for application assistance or to place an order.

FOR DETAILED NOZZLE PERFORMANCE DATA, SEE spray.com/steeltatalog/sectionE

OVERVIEW: FULLJET® NOZZLES

- Solid cone-shaped spray pattern with round impact area
- Vane design minimizes fluid turbulence to ensure uniform spray distribution and consistent spray coverage
- H and HF nozzles provide uniform distribution from 5.1 to 5324 (35 to 19842 lpm)
- DistribroJet® R, RF and RR extra large free passage versions eliminate clogging, provide uniform spray distribution from 27 to 8728 gpm (122 to 32530 lpm), and are available in six different spray angles ranging from 50° to 95°
- Maximum free passage (MFP) versions provide the largest free passage of nozzles of this type and uniform spray distribution from 50 to 582 gpm (191 to 2282 lpm)
- Ideal for gas cooling, coke cooling, sinter cooling, fire control, and dust control

FULLJET NOZZLE OPTIONS



FULLJET NOZZLE QUICK REFERENCE GUIDE

Model	Connection/Type	Connection Size (in.)	Materials
H	F, Cast	1-1/4 to 8	Brass, 316 stainless steel
HF	Flange, Cast	4 to 10	
R	F, Cast	2 to 8	Brass, 316 stainless steel
RR	M, Cast	2 to 8	
RF	Flange, Cast	4 to 12	
HMFP	F, Cast	2 to 3	316 stainless steel
HHMFP	M, Cast	2 to 3	

F = female thread; M = male thread. Other materials available upon request.

OVERVIEW: SPIRALJET® NOZZLES

- Solid cone-shaped spray pattern
- Open passages ideal for use with fluids with particulates
- Maximum liquid throughput for a given pipe size
- Spray angles from 60° to 170°
- Uniform spray distribution from .7 to 3320 gpm (2.7 to 11967 lpm)
- Operating pressures up to 400 psi (25 bar)
- Ideal for gas cooling, dust control, fire control

SPIRALJET NOZZLE OPTIONS



HHSJ
1/4" to 2" male conn.
Hex body style/316 stainless steel



HHSJX
3/8" to 2" male conn.
Extra large free passage design
Hex body style/brass

SPIRALJET NOZZLE QUICK REFERENCE GUIDE

Model	Connection/Type	Connection Size (in.)	Materials
HHSJ	M, Hex	1/4 to 2	Brass, 316 stainless steel
	M, Flats, Cast	1/4 to 4	316 stainless steel
	M, Round	1/4 to 4	Polyvinyl chloride, PTFE
HHSJX	M, Hex	3/8 to 2	Brass
	M, Flats, Cast	3/8 to 2	316 stainless steel
	M, Round	3/8 to 2	Polypropylene, polyvinyl chloride

F = female thread; M = male thread. Other materials available upon request.

PLACING YOUR ORDER

Call your local steel specialist for application assistance or to place an order.

FOR DETAILED NOZZLE PERFORMANCE DATA, SEE spray.com/steeltatalog/sectionE

OVERVIEW: UNIJET® NOZZLES

- Quick-connect nozzles reduce maintenance time – bodies remain on pipe/header
- Save on nozzle replacement costs – bodies can be reused, only spray tips are replaced; tips fit on male or female bodies
- Solid cone-shaped spray pattern with round impact area or cone-shaped spray pattern with square-like impact area for coverage of rectangular areas or spray zones
- Spray angles: Standard – 43° to 91°
- Uniform spray distribution from .08 to 7.4 gpm (.3 to 28 lpm)
- Operating pressures up to 300 psi (20 bar)
- Ideal for dust control

UNIJET NOZZLE OPTIONS



TG spray tip
Standard spray pattern



TG-SQ spray tip
Cone-shaped spray with square-like impact area

UNIJET NOZZLE QUICK REFERENCE GUIDE

Model	Connection/Type	Materials
TG	T male and TT female body options	Brass, 303 stainless steel
TG-SQ	T male and TT female body options	

PLACING YOUR ORDER

Call your local steel specialist for application assistance or to place an order.

FOR DETAILED NOZZLE PERFORMANCE DATA, SEE spray.com/steeltcatalog/sectionE



OVERVIEW: WHIRLJET® NOZZLES

- Hollow cone spray pattern with a circular impact area
- Large, unobstructed flow passages minimize clogging
- Good atomization of liquids at lower pressures
- Removable caps for easy inspection and cleaning on some models
- Slope-bottom design models reduce the drilling effect of the fluid vortex in the fluid chamber and premature wear
- AX and BX nozzles form smaller drops and operate at flow rates from .03 to .38 gpm (.19 to 145 lpm)
- CX and CF nozzles feature higher flow rates – 4.4 to 2362 gpm *17.1 to 9010 lpm)
- E nozzles offer extra wide spray angle and provide flow rates from .20 to 16.8 gpm (.76 to 64 lpm)
- BD nozzles have a lower profile and provide flow rates from 11 to 38 (41 to 145 lpm)
- Ideal for gas cooling and dust control

WHIRLJET NOZZLE OPTIONS

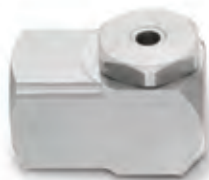

AX
1/8" to 3/4" female conn.
Slope-bottom design
Removable cap



BX
1/8" to 3/4" male conn.
Slope-bottom design
Removable cap



CX
1" to 2-1/2" female conn.
Slope-bottom design
One-piece cast-type



CF
4" to 6" flange conn.
Two-piece cast type



E
1/4" to 3/8" female conn.
One piece bar stock



BD
3/8" to 1-1/2" male conn.
In-line nozzle
Removable cap

PLACING YOUR ORDER

Call your local steel specialist for application assistance or to place an order.

FOR DETAILED NOZZLE PERFORMANCE DATA, SEE spray.com/steeltatalog/sectionE



WHIRLJET® NOZZLE QUICK REFERENCE GUIDE

Model	Connection/Type	Connection Size (in.)	Materials
AX	F	1/8 to 3/4	Brass, mild steel, 303 stainless steel, 316 stainless steel
BX	M	1/8 to 3/4	
CX	F, Cast	1 to 2-1/2	Brass, 316 stainless steel
CF	Flange, Cast	4 to 6	Brass, 316 stainless steel
E	F	1/4 to 1/2	303 stainless steel
BD	M	3/8 to 1-1/2	Brass, 303 stainless steel

F = female thread; M = male thread.

PLACING YOUR ORDER

Call your local steel specialist for application assistance or to place an order.

FOR DETAILED NOZZLE PERFORMANCE DATA, SEE spray.com/steeltatalog/sectionE



OVERVIEW: SPIRALJET® NOZZLES

- Hollow cone spray pattern with a circular impact area
- Minimal clogging – maximum flow through passages of any nozzle of comparable size
- Spray angles: Standard – 50° to 180°
- Uniform spray distribution from .49 to 3320 gpm (2.0 to 11967 lpm)
- Operating pressures up to 400 psi (25 bar)
- Precision impact blade angles distribute drops and provide excellent coverage – ideal for washing, rinsing and cooling
- Compact size

SPIRALJET NOZZLE OPTIONS



SPIRALJET NOZZLE QUICK REFERENCE GUIDE

Model	Connection/Type	Connection Size (in.)	Materials
BSJ	M, Hex	1/4 to 2	Brass, 316 stainless steel
	M, Flats	1/4 to 4	316 stainless steel
	M, Flats, Cast	1/4 to 4	316 stainless steel
	M, Round	1/4 to 4	PTFE, polyvinyl chloride

F = female thread; M = male thread.

PLACING YOUR ORDER

Call your local steel specialist for application assistance or to place an order.

FOR DETAILED NOZZLE PERFORMANCE DATA, SEE spray.com/steeltatalog/sectionE

AUTOJET® GAS COOLING SYSTEMS

OVERVIEW:

AutoJet Gas Cooling Systems provide effective emission control using closed-loop control of all automated spray system components – nozzles, pumps, sensors and other hydraulic and pneumatic components – to simplify and streamline the gas cooling process. They can be used with a wide range of nozzles including our standard and anti-bearding FloMax® nozzles.

BENEFITS:

- Precise control of gas temperature enables increased production and improved operating efficiency
- Automated control of spray nozzles optimizes performance, reduces energy costs
- Closed-loop control ensures precise cooling even with variable operating conditions
- Total control of all system components minimizes the need for operator involvement
- If system cannot make a needed adjustment based on operating conditions, operators are notified via alarms
- Total solution from a single source eliminates integration problems and the hassles of working with multiple vendors

Note: System availability may vary by region. Contact your local steel specialist for assistance.



PLACING YOUR ORDER

Call your local steel specialist for application assistance or to place an order.

SPRAY LANCES

We provide a wide range of design, fabrication and testing services for spray lances:

- Assistance with lance design, placement in the gas stream and spray direction
- Computational Fluid Dynamics (CFD) modeling to determine how the injected fluid interacts with the receiving stream to validate performance
- Manufacturing to meet a wide range of code requirements
- Spray and flow testing, radiographic, ferrite weld, ultrasonic examination and more



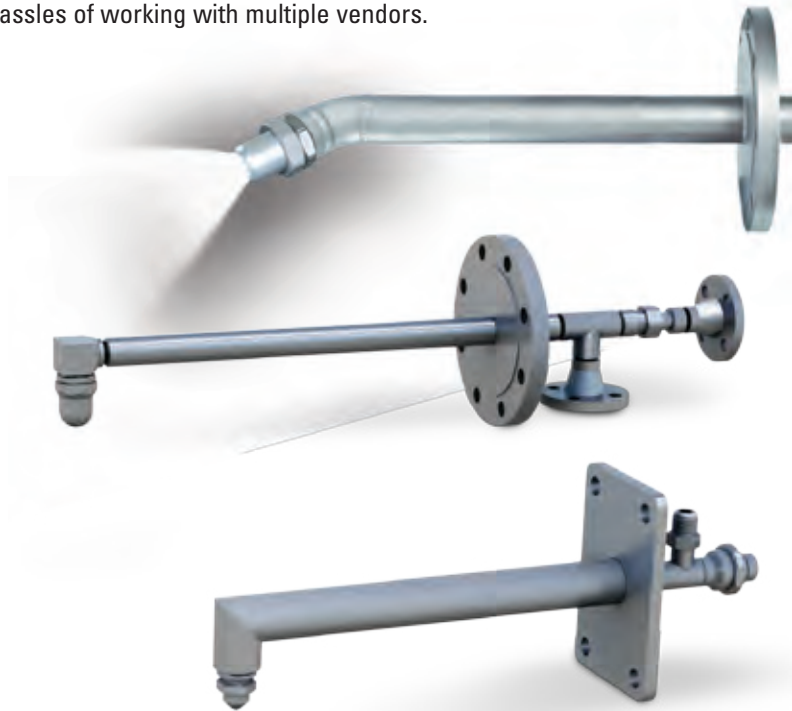



Spray lances can be controlled by AutoJet Gas Cooling Systems for automatic adjustment of spray performance based on operating conditions. In addition, a total solution from a single source eliminates integration problems and the hassles of working with multiple vendors.



MORE INFORMATION ON SPRAY LANCES: SEE SECTION A







TECHNICAL REFERENCE
TABLE OF CONTENTS

**KEY CONSIDERATIONS IN SPRAY NOZZLE SELECTION
AND PERFORMANCE OPTIMIZATION**

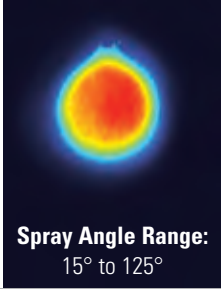
	PAGE
 Basic nozzle characteristics	F2
 Capacity and specific gravity	F5
 Spray performance considerations	F6
 Spray drop size	F7
 Impact	F8
 Operating pressure and nozzle materials	F9
 Maintenance tips	F10

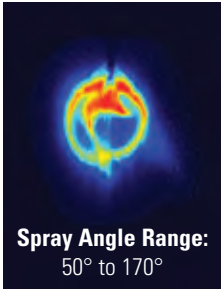

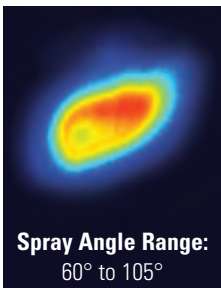
Spray nozzles are precision components designed to yield very specific performance under specific conditions. To help you determine the best nozzle type for your application, the following chart summarizes the performance that each nozzle type is designed to deliver. Visit [youtube.com/sprayingystems](https://www.youtube.com/sprayingystems) for video demonstrations of spray patterns.

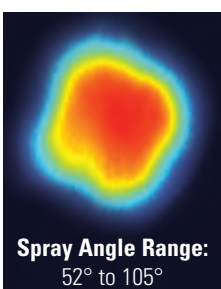
		LASER SHEET IMAGE
	<p>FULL CONE NOZZLES</p> <ul style="list-style-type: none"> • Uses a unique internal vane design to produce a solid cone-shaped spray pattern • Spray pattern consists of medium- to large-sized drops 	<p>Typical applications:</p> <ul style="list-style-type: none"> • Metal cooling • Washing/rinsing • Dust control • Fire control • Coating  <p>Spray Angle Range: 15° to 125°</p>
	<p>FULL CONE (SPIRAL-TYPE) NOZZLES</p> <ul style="list-style-type: none"> • Produces a solid cone-shaped spray pattern when the fluid exits the voids in the spiral • Spray pattern is not as uniform as full cone nozzles with an internal vane • Spray pattern consists of relatively coarse drops 	<p>Typical applications:</p> <ul style="list-style-type: none"> • Quenching • Dust control • Fire control • Flue gas desulfurization (FGD)  <p>Spray Angle Range: 50° to 170°</p>
	<p>FULL CONE (OVAL SPRAY) NOZZLES</p> <ul style="list-style-type: none"> • Uses a unique internal vane to produce a solid cone-shaped spray pattern with oval impact area with a width approximately one-half its length • Spray pattern consists of medium- to large-sized drops 	<p>Typical applications:</p> <ul style="list-style-type: none"> • Metal cooling • Air/gas washing • Dust control • Fire control  <p>Spray Angle Range: 60° to 105°</p>
	<p>FULL CONE (SQUARE SPRAY) NOZZLES</p> <ul style="list-style-type: none"> • Uses a unique internal vane to produce a solid cone-shaped spray with square impact area • Spray pattern is uniform across entire spray area • Spray pattern consists of medium- to large-sized drops 	<p>Typical applications:</p> <ul style="list-style-type: none"> • Metal cooling • Air/gas washing • Dust control • Fire control  <p>Spray Angle Range: 52° to 105°</p>

NOTE: The spray pattern images on the right were acquired in our spray laboratories using Laser Sheet Imaging (LSI). LSI images are collected by passing a laser sheet through a cross-section of the spray plume and imaging with a light-filtered camera. The distributions are directly proportional to the surface area distribution of the sprayed material (red: high, blue: low, black: zero). Volume distributions typically are similar to surface area distributions for these nozzles, depending on the local drop size distributions.

BASIC NOZZLE CHARACTERISTICS

TECHNICAL REFERENCE



FLAT (EVEN) NOZZLES

- Provides even distribution of medium-sized drops throughout the thin, rectangular spray pattern
- When used on a header, nozzles are positioned for edge-to-edge pattern contact

Typical applications:

- Descaling
- Metal cooling
- Washing/cleaning
- Coating

LASER SHEET IMAGE

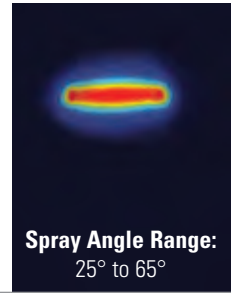

FLAT SPRAY (TAPERED) NOZZLES

- Produces a tapered-edge flat spray pattern
- Used on spray headers to provide uniform coverage as a result of overlapping distributions

Typical applications:

- Descaling
- High-pressure cleaning
- Metal cooling

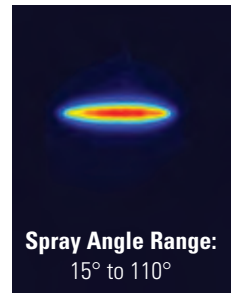

FLAT SPRAY (DEFLECTED-TYPE) NOZZLES

- Uses a deflector surface to form an even flat spray pattern consisting of medium-sized drops
- Large free passage design reduces clogging through the round orifice

Typical applications:

- Washing/cleaning
- Debris removal



HOLLOW CONE (WHIRLCHAMBER-TYPE) NOZZLES

- Uses a whirlchamber to rotate the fluid and produce a circular spray pattern
- Ideal for use when a combination of small drop size and higher capacity is needed

Typical applications:

- Air, gas and water cooling
- Dust control
- Flue gas desulfurization (FGD)
- Cooling products on conveyors
- Water aeration

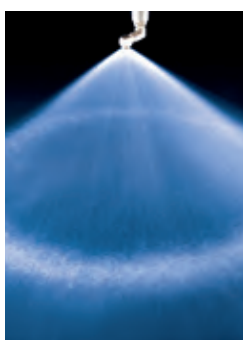

HOLLOW CONE (DEFLECTED-TYPE) NOZZLES

- Uses a deflector cap to form an umbrella-shaped hollow cone pattern

Typical applications:

- Dust control
- Fire control
- Flush cleaning of tube/pipe interiors

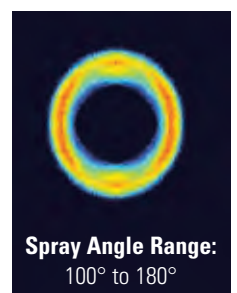



HOLLOW CONE (SPIRAL-TYPE) NOZZLES

- Produces a circular spray pattern when the fluid exits the voids in the spiral
- Drops are slightly coarser than those in other hollow cone sprays
- Provides a high flow rate in a compact nozzle size
- One-piece design produces maximum throughput for a given pipe size

Typical applications:

- Dust control
- Fire control
- Flue gas desulfurization (FGD)

LASER SHEET IMAGE

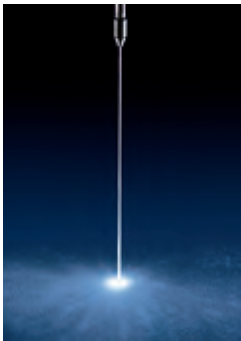
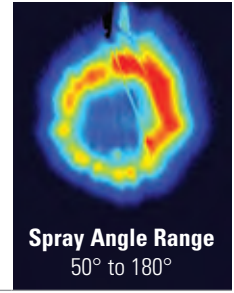

SOLID STREAM NOZZLES

- Produces a solid stream spray with the highest impact per unit area

Typical applications:

- Laminar flow operations
- Washing/cleaning

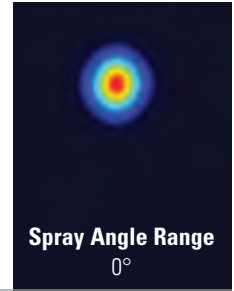

ATOMIZING (HYDRAULIC, FINE MIST) NOZZLES

- Produces a finely atomized, low capacity spray in a hollow cone pattern without use of compressed air

Typical applications:

- Evaporative cooling
- Dust control
- Coating

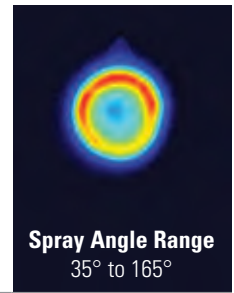

AIR ATOMIZING AND AIR ASSISTED NOZZLES

- Produces a variety of cone and flat spray patterns through atomization of liquid by compressed air
- Internal mix impingement atomization forms very fine drops

Typical applications:

- Evaporative cooling
- Coating
- Metal cooling

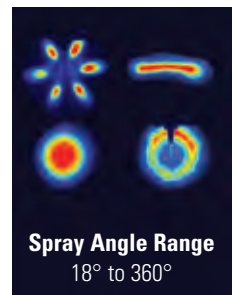

NOTE: The spray pattern images on the right were acquired in our spray laboratories using Laser Sheet Imaging (LSI). LSI images are collected by passing a laser sheet through a cross-section of the spray plume and imaging with a light-filtered camera. The distributions are directly proportional to the surface area distribution of the sprayed material (red: high, blue: low, black: zero). Volume distributions typically are similar to surface area distributions for these nozzles, depending on the local drop size distributions.

CAPACITY – FLUID CAPACITY FOR HYDRAULIC NOZZLES VARIES WITH SPRAYING PRESSURE

The relationship of pressure and flow with a given orifice is:

$$\frac{Q_1}{Q_2} \sim \left(\frac{P_1}{P_2}\right)^n$$

Q = Flow Rate (in gpm or lpm)
P = Liquid pressure (in psi or bar)
n = Flow exponent

To approximate any unknown flow or pressure, use this formula when the other variables are known. The "n" exponent is used to approximate the ratio of pressure to flow based on the type of spray pattern.

Example:

To determine the flow rate of water for a 1/4G-10 standard full cone nozzle at 150 psi (10 bar), consult the performance charts in this catalog.

You will find that:

- The spray angle is 65°
- Flow (Q₁) at 40 psi = 1.9 gpm
- Pressure (P₁) = 40 psi
- Pressure (P₂) = 150 psi

Solving for Q₂ = 3.5 gpm

$$Q_2 = \frac{Q_1}{(P_1/P_2)^n} = \frac{1.9 \text{ gpm}}{(40/150)^{.46}}$$

- The spray angle is 65°
- Flow (Q₁) at 3 bar = 7.5 lpm
- Pressure (P₁) = 3 bar
- Pressure (P₂) = 10 bar

Solving for Q₂ = 13 lpm

$$Q_2 = \frac{Q_1}{(P_1/P_2)^n} = \frac{7.5 \text{ lpm}}{(3/10)^{.46}}$$

FLOW EXPONENT FOR SPECIFIC HYDRAULIC NOZZLE TYPES

Nozzle Type	Exponent "n"
Flat Spray Nozzles – All	.50
Full cone Nozzles – Vaneless, 15° and 30° Series	
Hollow Cone Nozzles – All	
Solid Stream Nozzles – All	
Spiral Nozzles – All	
Full Cone Nozzles – Standard, Square, Oval and Large Capacity	.46
Full Cone Nozzles – Wide Spray and Wide Square Spray	.44

Visit spray.com/sprayware for online flow rate and spray coverage calculators.

SPECIFIC GRAVITY

All capacity tabulations in this catalog are based on water. Since the specific gravity of a liquid affects its flow rate, tabulated catalog capacities must be multiplied by the conversion factor that applies to the specific gravity of the liquid being sprayed as explained below.

Specific gravity is the ratio of the density of a fluid compared to the density of water. The specific gravity of water is defined as 1. When spraying fluids other than water, specific gravity must be considered in the flow calculations.

$$Q_2 = Q_1(\text{water}) \times \frac{1}{\sqrt{SG}}$$

Using the previous example:

- Fluid sprayed is heavier than water and has a specific gravity of 1.4
- Flow of water at 150 psi = 3.5 gpm
- Heavy fluid (Q₂) = Q₁(water)*1/√1.4

$$Q_2 = \frac{3.5 \text{ gpm} * 1}{\sqrt{1.4}} = 2.95 \text{ gpm}$$

- Fluid sprayed is heavier than water and has a specific gravity of 1.4
- Flow of water at 10 bar = 13 lpm
- Heavy fluid (Q₂) = Q₁(water)*1/√1.4

$$Q_2 = \frac{13 \text{ lpm} * 1}{\sqrt{1.4}} = 11 \text{ lpm}$$

SPECIFIC GRAVITY VERSUS CONVERSION FACTOR

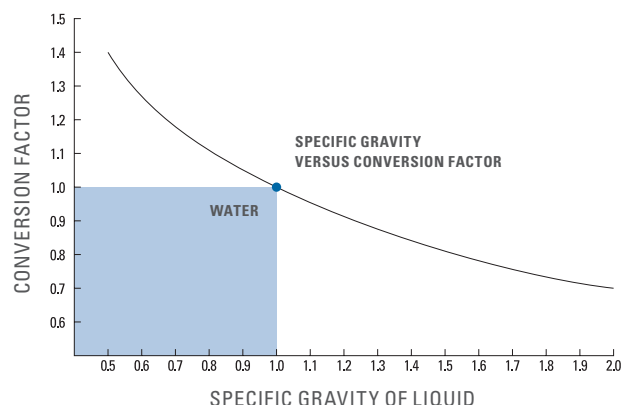

KEY: Conversion factor multiplied by the capacity of the nozzle when spraying water gives the capacity of the nozzle when spraying a liquid with a specific gravity corresponding to the conversion factor. This conversion factor accounts only for the effect of specific gravity on capacity and does not account for other factors affecting capacity.

SPRAY ANGLE AND COVERAGE

Tabulated spray angles indicate approximate spray coverage based on spray or distribution of water. In actual spraying, the effective spray angle varies with spray distance. Liquids more viscous than water form relatively smaller spray angles (or even a solid stream), depending upon viscosity, nozzle capacity and spraying pressure. Liquids with surface tensions lower than water will produce relatively wider spray angles than those listed for water. This table lists the theoretical coverage of spray patterns as calculated from the included spray angle of the spray and the distance from the nozzle orifice. Values are based on the assumption that the spray angle remains the same throughout the entire spray distance. In actual practice, the tabulated spray angle does not hold for long spray distances. If the spray coverage requirement is critical, request data sheets for specific spray coverage data.

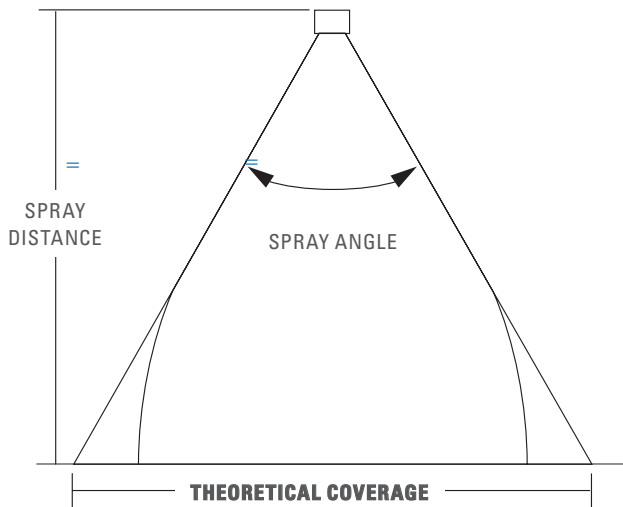

Example: A spray nozzle with an angle of 65° spraying 15" (39 cm) from the target provides 19.2" (48.8 cm) of coverage

THEORETICAL SPRAY COVERAGE AT VARIOUS DISTANCES IN INCHES (CM) FROM NOZZLE ORIFICE

Spray Angle	2 in.	5 cm	4 in.	10 cm	6 in.	15 cm	8 in.	20 cm	10 in.	25 cm	12 in.	30 cm	15 in.	40 cm	18 in.	50 cm	24 in.	60 cm	30 in.	70 cm	36 in.	80 cm	48 in.	100 cm
5°	.2	.4	.4	.9	.5	1.3	.7	1.8	.9	2.2	1.1	2.6	1.3	3.5	1.6	4.4	2.1	5.2	2.6	6.1	3.1	7.0	4.2	8.7
10°	.4	.9	.7	1.8	1.1	2.6	1.4	3.5	1.8	4.4	2.1	5.3	2.6	7.0	3.1	8.8	4.2	10.5	5.2	12.3	6.3	14.0	8.4	17.5
15°	.5	1.3	1.1	2.6	1.6	4.0	2.1	5.3	2.6	6.6	3.2	7.9	3.9	10.5	4.7	13.2	6.3	15.8	7.9	18.4	9.5	21.1	12.6	26.3
20°	.7	1.8	1.4	3.5	2.1	5.3	2.8	7.1	3.5	8.8	4.2	10.6	5.3	14.1	6.4	17.6	8.5	21.2	10.6	24.7	12.7	28.2	16.9	35.3
25°	.9	2.2	1.8	4.4	2.7	6.7	3.5	8.9	4.4	11.1	5.3	13.3	6.6	17.7	8.0	22.2	10.6	26.6	13.3	31.0	15.9	35.5	21.2	44.3
30°	1.1	2.7	2.1	5.4	3.2	8.0	4.3	10.7	5.4	13.4	6.4	16.1	8.1	21.4	9.7	26.8	12.8	32.2	16.1	37.5	19.3	42.9	25.7	53.6
35°	1.3	3.2	2.5	6.3	3.8	9.5	5.0	12.6	6.3	15.8	7.6	18.9	9.5	25.2	11.3	31.5	15.5	37.8	18.9	44.1	22.7	50.5	30.3	63.1
40°	1.5	3.6	2.9	7.3	4.4	10.9	5.8	14.6	7.3	18.2	8.7	21.8	10.9	29.1	13.1	36.4	17.5	43.7	21.8	51.0	26.2	58.2	34.9	72.8
45°	1.7	4.1	3.3	8.3	5.0	12.4	6.6	16.6	8.3	20.7	9.9	24.9	12.4	33.1	14.9	41.4	19.9	49.7	24.8	58.0	29.8	66.3	39.7	82.8
50°	1.9	4.7	3.7	9.3	5.6	14.0	7.5	18.7	9.3	23.3	11.2	28.0	14.0	37.3	16.8	46.6	22.4	56.0	28.0	65.3	33.6	74.6	44.8	93.3
55°	2.1	5.2	4.2	10.4	6.3	15.6	8.3	20.8	10.3	26.0	12.5	31.2	15.6	41.7	18.7	52.1	25.0	62.5	31.2	72.9	37.5	83.3	50.0	104
60°	2.3	5.8	4.6	11.6	6.9	17.3	9.2	23.1	11.5	28.9	13.8	34.6	17.3	46.2	20.6	57.7	27.7	69.3	34.6	80.8	41.6	92.4	55.4	115
65°	2.5	6.4	5.1	12.7	7.6	19.1	10.2	25.5	12.7	31.9	15.3	38.2	19.2	51.0	22.9	63.7	30.5	76.5	38.2	89.2	45.8	102	61.2	127
70°	2.8	7.0	5.6	14.0	8.4	21.0	11.2	28.0	14.0	35.0	16.8	42.0	21.0	56.0	25.2	70.0	33.6	84.0	42.0	98.0	50.4	112	67.2	140
75°	3.1	7.7	6.1	15.4	9.2	23.0	12.3	30.7	15.3	38.4	18.4	46.0	23.0	61.4	27.6	76.7	36.8	92.1	46.0	107	55.2	123	73.6	153
80°	3.4	8.4	6.7	16.8	10.1	25.2	13.4	33.6	16.8	42.0	20.2	50.4	25.2	67.1	30.3	83.9	40.3	101	50.4	118	60.4	134	80.6	168
85°	3.7	9.2	7.3	18.3	11.0	27.5	14.7	36.7	18.3	45.8	22.0	55.0	27.5	73.3	33.0	91.6	44.0	110	55.0	128	66.0	147	88.0	183
90°	4.0	10.0	8.0	20.0	12.0	30.0	16.0	40.0	20.0	50.0	24.0	60.0	30.0	80.0	36.0	100	48.0	120	60.0	140	72.0	160	96.0	200
95°	4.4	10.9	8.7	21.8	13.1	32.7	17.5	43.7	21.8	54.6	26.2	65.5	32.8	87.3	39.3	109	52.4	131	65.5	153	78.6	175	105	218
100°	4.8	11.9	9.5	23.8	14.3	35.8	19.1	47.7	23.8	59.6	28.6	71.5	35.8	95.3	43.0	119	57.2	143	71.6	167	85.9	191	114	238
110°	5.7	14.3	11.4	28.6	17.1	42.9	22.8	57.1	28.5	71.4	34.3	85.7	42.8	114	51.4	143	68.5	171	85.6	200	103	229	-	286
120°	6.9	17.3	13.9	34.6	20.8	52.0	27.7	69.3	34.6	86.6	41.6	104	52.0	139	62.4	173	83.2	208	104	243	-	-	-	-
130°	8.6	21.5	17.2	42.9	25.7	64.3	34.3	85.8	42.9	107	51.5	129	64.4	172	77.3	215	103	257	-	-	-	-	-	-
140°	10.9	27.5	21.9	55.0	32.9	82.4	43.8	110	54.8	137	65.7	165	82.2	220	98.6	275	-	-	-	-	-	-	-	-
150°	14.9	37.3	29.8	74.6	44.7	112	59.6	149	74.5	187	89.5	224	112	299	-	-	-	-	-	-	-	-	-	-
160°	22.7	56.7	45.4	113	68.0	170	90.6	227	113	284	-	-	-	-	-	-	-	-	-	-	-	-	-	-
170°	45.8	114	91.6	229	-	-	-	-	-	-	-	-	-	-	-	-	-	-	-	-	-	-	-	-

Visit spray.com/sprayware for online flow rate and spray coverage calculators.



SPRAY DROP SIZE (ATOMIZATION)

Drop size refers to the size of the individual spray drops that comprise a nozzle's spray pattern. Each spray provides a range of drop sizes; this range is referred to as drop size distribution. Drop size distribution is dependent on the spray pattern type and varies significantly from one type to another. The smallest drop sizes are achieved by air atomizing nozzles while the largest drops are produced by full cone hydraulic spray nozzles.

ACTUAL DROP SIZES

- 500 μm
- 1200 μm
- 5500 μm

One inch = 25,400 μm
One millimeter = 1,000 μm
μm = micrometers

Liquid properties, nozzle capacity, spraying pressure and spray angle also affect drop size. Lower spraying pressures provide larger drop sizes. Conversely, higher spraying pressures yield smaller drop sizes. Within each type of spray pattern the smallest capacities produce the smallest spray drops, and the largest capacities produce the largest spray drops.

DROP SIZE BY SPRAY PATTERN TYPE AT VARIOUS PRESSURES AND CAPACITIES

Spray Pattern Type	10 psi (0.7 bar)			40 psi (2.8 bar)			100 psi (7 bar)		
	Capacity		VMD	Capacity		VMD	Capacity		VMD
	gpm	lpm	microns	gpm	lpm	microns	gpm	lpm	microns
Air Atomizing	.005 .02	.02 .08	20 100	.008 8	.03 30	15 200	12	45	400
Fine Spray	.22	.83	375	.03 .43	.1 1.6	110 330	.05 .69	.2 2.6	110 290
Hollow Cone	.05 12	.19 45	360 3400	.10 24	.38 91	300 1900	.16 38	.61 144	200 1260
Flat Fan	.05 5	.19 18.9	260 4300	.10 10	.38 38	220 2500	.16 15.8	.61 60	190 1400
Full Cone	.10 12	.38 45	1140 4300	.19 23	.72 87	850 2800	.30 35	1.1 132	500 1720

Based on a sampling of nozzles selected to show the wide range of possible drop sizes available.

DROP SIZE TERMINOLOGY

Terminology is often a major source of discrepancy and confusion in understanding drop size. To accurately compare drop sizes from one nozzle to another, the same diameters have to be used. Drop size is usually expressed in microns (micrometers). Following are the most popular characteristic diameters and their definitions.

VOLUME MEDIAN DIAMETER (VMD)

also expressed as $D_{v0.5}$ and Mass Median Diameter (MMD)

A means of expressing drop size in terms of the volume of liquid sprayed. The Volume Median Diameter drop size when measured in terms of volume (or mass) is a value where 50% of the total volume of liquid sprayed is made up of drops with diameters larger than the median value and 50% with smaller diameters.

SAUTER MEAN DIAMETER (SMD)

also expressed as D_{32}

A means of expressing the fineness of a spray in terms of the surface area produced by the spray. The Sauter Mean Diameter is the diameter of a drop having the same volume-to-surface area ratio as the total volume of all the drops to the total surface area of all the drops.

NUMBER MEDIAN DIAMETER (NMD)

also expressed as $D_{No.5}$

A means of expressing drop size in terms of the number of drops in the spray. This means that 50% of the drops by count or number are smaller than the median diameter and 50% of the drops are larger than the median diameter.

More drop size data is available on all types of spray nozzles. For more information, contact your local steel specialist.

IMPACT

Impact is the measure of force imparted on a surface by a spray pattern at a given distance. It can be expressed in several ways. All definitions are derived from the most basic equation of total impact force. This is the force that any flow, at any pressure, is capable of making on a surface. This does not account for orifice shape, nozzle type, fluid properties and other factors.

$$I = K \times Q \times \sqrt{P}$$

Total theoretical impact = constant (based on units) x flow (at pressure P) x square root of pressure (P)

	I	lbs.(f)	kg(f)	Newtons	Newtons
I = total theoretical spray impact	K	.0526	.024	.24	.745
K = constant	Q	gpm	lpm	lpm	lpm
Q = flow rate	P	psi	kg/cm ²	bar	MPa
P = liquid pressure					

The constant (K), is a unit conversion based on the measurement system used. The conversions are listed in the chart above.

Example:

$$I = .0526 \times 10.5 \text{ gpm} \times \sqrt{2500 \text{ psi}}$$

$$I = 27.6 \text{ lbs(f)}$$

Contact your local steel specialist for assistance in determining impact in your application.

FACTORS THAT AFFECT IMPACT

- Loose material and standing liquid both dissipate some portion of the flow energy and can reduce impact
- As spray travels through the air to reach the target surface, drops decelerate and the momentum of the spray is reduced. Nozzle size, pressure, spray style and spray height each play a role in deceleration
- Closer target distances result in higher normalized impact pressure, but also result in smaller coverage area per nozzle
- Increasing pressure will increase total impact. Changes in impact also affect the spray pattern and increase turbulence
- Turbulence has a negative effect on nozzle performance, the service life of the nozzle and header

LATERAL IMPACT AND SPECIFIC IMPACT

Lateral impact, sometimes called lineal impact, is the force per unit length across the spray width. Usually expressed in lb./in. or kg/cm, it shows the volumetric distribution pattern and the evenness of the impact across the spray. It also provides an indication of relative cleaning effectiveness. Flat spray patterns have fairly uniform impact distribution across the effective spray coverage.

Specific impact is the total impact force divided by a given area. Because spray patterns have both an effective impact area, where the majority of the spray hits, and a somewhat larger total impact area, two types of specific impact can be calculated.

- **Average specific impact** is the total impact force divided by the total impact area
- **Maximum specific impact** is the total impact force divided by the effective impact area

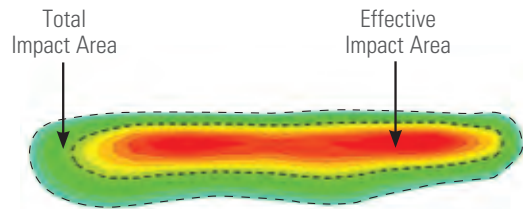

Both are expressed in terms of force per unit area. Maximum specific impact is a direct indication of spray intensity applied to a surface and can be used to compare spray effectiveness under various conditions.

OPERATING PRESSURE

The values given in the tabulation sections of this catalog indicate the most commonly used pressure ranges for the associated spray nozzle or accessory.

Contact your local steel specialist if your application requires pressure ranges beyond those stated in this catalog.

NOZZLE MATERIALS

For each nozzle there is a selection of “standard” materials that have been determined to meet the usual requirements of the applications most commonly associated with that type of nozzle. Standard materials include brass, steel, various stainless steels, hardened stainless steels, many plastics and various carbides. Spray nozzles can also be supplied in other materials upon special request including:

- AMPCO® 8
- CARPENTER® 20 (Alloy 20)
- Ceramics
- CUPRO® NICKEL
- Graphite
- HASTELLOY®
- INCONEL®
- MONEL®
- Nylon
- Polypropylene, PVC and CPVC
- REFRAK®
- Silicon carbide
- Stellite®
- Titanium
- Zirconium



NOZZLE WEAR

Nozzle wear is typically characterized by an increase in nozzle capacity, followed by a general deterioration of the spray pattern. Flat fan spray nozzles with elliptical orifices experience a narrowing of the spray pattern. In other spray pattern types, the distribution within the spray pattern deteriorates without substantially changing the coverage area. The increase in nozzle capacity can sometimes be recognized by a decrease in system operating pressure, particularly when using positive displacement pumps.

Materials having harder surfaces generally provide longer wear life. The chart below provides standard abrasion resistance ratios for different materials to help you determine if you should consider a different material for your nozzles, orifice inserts and/or spray tips.

Materials that offer better corrosion resistance are also available. However, the rate of chemical corrosion on specific nozzle materials is dependent on the solution being sprayed, its percent concentration and temperature, as well as the corrosion resistance of the nozzle material to the chemical must all be considered.

APPROXIMATE ABRASION RESISTANCE RATIOS

Spray Nozzle Material	Resistance Ratio
Aluminum	1
Brass	1
Polypropylene	1-2
Steel	1.5-2
MONEL	2-3
Stainless Steel	4-6
HASTELLOY	4-6
Hardened Stainless Steel	10-15
Stellite	10-15
Silicon Carbide (Nitride Bonded)	90-130
Ceramics	90-200
Carbides	180-250
Synthetic Ruby or Sapphire	600-2000

See Trademark Registration and Ownership, page i-1.

MAINTAINING SPRAY NOZZLES

Like any precision component, spray nozzles wear over time. Spray nozzle wear can be hard to detect. Small changes in performance can result in quality problems and wasted water, chemicals and electricity. The cost of using worn nozzles can be very significant – tens of thousands of dollars or more per year. Detecting nozzle wear in the early stages can prevent a significant profit drain.

USING NOZZLES THAT ARE SPRAYING JUST 15% OVER THE RATED CAPACITY*

	WASTE	COST OF EXCESS
WATER	1,701,835 gallons (6,442,146 liters)	US \$4,680
CHEMICALS	170,165 gallons (644,145 liters)	US \$170,164
WASTEWATER DISPOSAL	1,872,000 gallons (7,086,291 liters)	US \$7,956
TOTAL COST OF USING WORN NOZZLES:		US \$182,800

*Based on total system flow of 100 gpm (379 lpm). Water cost of US \$2.75/1000 gallons (3,785 liters). Chemical cost of US \$1.00 per gallon (\$0.264 per liter) and a dilution ratio of 10:1. System operates 2080 hours per year. Increased electricity cost, scrap and downtime due to quality problems are not included.

DETECTING WORN SPRAY NOZZLES

Visually inspecting nozzles is a start but unless wear is significant, it may not be detectable.

The graphic below illustrates this problem. The spray tip on the left is new and sprays properly. The spray tip on the right is worn and sprays 30% over capacity. The difference is undetectable by inspecting the nozzle, but spray collection data reveals the difference between the two tips.

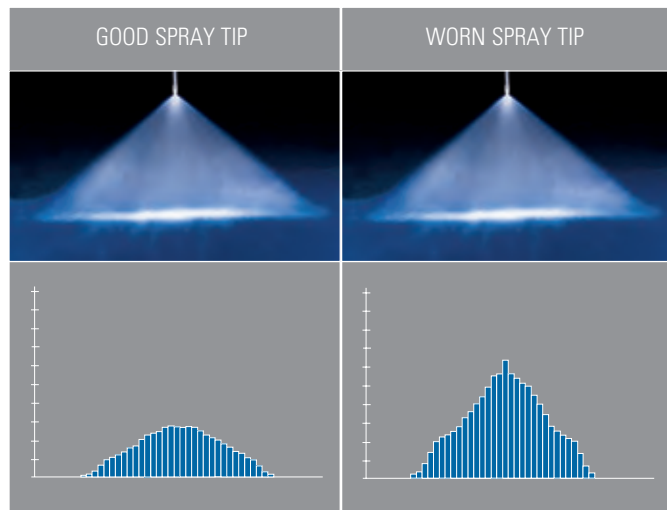

WATCH FOR THESE SIGNS OF NOZZLE WEAR:

- **Quality control issues and increased scrap.** Check for uneven coating, cooling, drying or cleaning and changes in temperature, dust content and humidity
- **Flow rate change:**
 - For centrifugal pumps: monitor flow meter readings to detect increases or collect and measure the flow from the spray nozzle for a given period of time at a specific pressure and compare them to flow rate readings from new, unused spray nozzles
 - For positive displacement pumps: monitor the liquid line pressure for decreases; the flow rate will remain constant
- **Spray pressure in the nozzle manifold:**
 - For centrifugal pumps: monitor for increases in liquid volume sprayed. The spraying pressure is likely to remain the same
 - For positive displacement pumps: monitor pressure gauge for decreases in pressure and reduction in impact on sprayed surfaces. The liquid volume sprayed is likely to remain the same. Also, monitor for increases in pressure due to clogged spray nozzles
- **Deterioration of spray pattern quality.** Visually inspect the spray pattern for changes. Check the spray angle with a protractor. Measure the width of the spray pattern on the sprayed surface

REPLACING WORN NOZZLES

Inspecting and maintaining your nozzles on a regular basis will help identify wear and extend service life. However, wear will occur over time and the only solution is to replace your nozzles. Here are a few guidelines to help you determine the optimal replacement interval:

- Are worn nozzles affecting product or process quality? If so, replace nozzles as soon as any wear is evident
- Is water conservation a priority? If so, replace nozzles as soon as wear is evident
- How much are you spending by continuing to use worn nozzles? How do the additional costs for water, chemicals, electricity and wastewater disposal compare with the cost of replacement nozzles?
- Is precise spray performance important to your overall process? If so, you may want to set pre-determined dates for nozzle replacement such as annual or semi-annual maintenance shutdowns

For more information on nozzle maintenance and replacement, visit spray.com. Or, contact your local steel specialist for assistance developing a nozzle maintenance program.

PERFORMANCE DATA











PERFORMANCE DATA
INTRODUCTION

PERFORMANCE YOU CAN COUNT ON FOR ALL THE SPRAY APPLICATIONS IN YOUR MILL

The performance data section of *Spray Technology for Steels Mills* is organized by product line, then by spray pattern type. Performance and dimensional data are presented in both English units, beginning on page G4, and metric units, beginning on page G70.

Our experienced steel industry experts are available to help you with product applications and system optimization. To locate your local sales engineer, [click here](#)

SPRAY TECHNOLOGY FOR STEEL MILLS

-  [INTRODUCTION AND TABLE OF CONTENTS](#)
-  [FABRICATION AND TESTING](#)
-  [SOLUTIONS FOR CONTINUOUS CASTING](#)
-  [SOLUTIONS FOR HOT ROLLING MILLS](#)
-  [SOLUTIONS FOR COLD ROLLING MILLS](#)
-  [SOLUTIONS FOR IRON AND STEELMAKING](#)
-  [FABRICATION AND TESTING](#)
-  [TECHNICAL REFERENCE](#)



PERFORMANCE DATA
TABLE OF CONTENTS

CONTINUOUS CASTING NOZZLES

FLAT SPRAY

	ENGLISH UNITS	METRIC UNITS
50070, 50085, 56780 and 64010 NCJ CasterJet® nozzles	G4 ▶	G70 ▶
D40208 CasterJet nozzles	G5 ▶	G71 ▶
D41968 and D41936 anti-pulsing CasterJet nozzles	G6 ▶	G72 ▶
23530-XT and 58090-XT VeeJet® nozzles	G7 ▶	G73 ▶
56862 nozzles	G8 ▶	G74 ▶
49784-XT VeeJet spray tips	G8 ▶	G74 ▶

FULL CONE

58050 and 58160 CasterJet nozzles	G9 ▶	G75 ▶
D40206 CasterJet nozzles	G10 ▶	G76 ▶
HHCC FullJet® nozzles	G11 ▶	G77 ▶
HHX FullJet nozzles	G12 ▶	G78 ▶
P45075 FullJet nozzles	G13 ▶	G79 ▶

RECTANGULAR SPRAY

D41502 CasterJet nozzles	G14 ▶	G80 ▶
25381 and D41828 spray tips	G15 ▶	G81 ▶
D41539 spray tips	G16 ▶	G82 ▶

IMPINGEMENT COOLING

26010-1/4J nozzles	G17 ▶	G83 ▶
--------------------	-------	-------

DESCALING NOZZLES

	ENGLISH UNITS	METRIC UNITS
DescaleJet® nozzles	G18 ▶	G84 ▶
DescaleJet Pro tips	G19 ▶	G85 ▶
CVCN check valves	G19 ▶	G85 ▶

FLAT SPRAY NOZZLES

	ENGLISH UNITS	METRIC UNITS
H-VV, H-VVL and H-DT VeeJet nozzles	G20 ▶	G86 ▶
H-U, H-DU and U VeeJet nozzles	G23 ▶	G89 ▶
MEG and MEG-SSTC WashJet® nozzles	G28 ▶	G94 ▶
WEG and IMEG® WashJet nozzles	G29 ▶	G95 ▶
K FloodJet® nozzles	G31 ▶	G97 ▶
TEK FloodJet nozzles	G32 ▶	G98 ▶
P FlatJet® nozzles	G33 ▶	G99 ▶
TPU and 13802 UniJet® spray tips	G34 ▶	G100 ▶
14784 UniJet spray tips	G40 ▶	G106 ▶
18897 VeeJet spray tips	G41 ▶	G107 ▶
49803 and 49807 VeeJet spray tips	G43 ▶	G109 ▶
58606 and 20799 VeeJet spray tips	G45 ▶	G111 ▶
FSUN-S VeeJet spray tips	G46 ▶	G112 ▶

FULL CONE NOZZLES

	ENGLISH UNITS	METRIC UNITS
G, GG, H, HH, HF, GA and GGA FullJet nozzles	G48 ▶	G114 ▶
HMFP and HHMFP Maximum Free Passage FullJet nozzles	G52 ▶	G118 ▶
HHSJ SpiralJet® nozzles	G54 ▶	G120 ▶
HHSJX SpiralJet nozzles	G55 ▶	G121 ▶
VK nozzles	G56 ▶	G122 ▶
GANV and GGANV FullJet nozzles	G57 ▶	G123 ▶
R, RR and RF DistribioJet® nozzles	G58 ▶	G124 ▶

SQUARE SPRAY

G-SQ, GG-SQ and HH-SQ FullJet nozzles	G60 ▶	G126 ▶
TG and TG-SQ UniJet spray tips	G61 ▶	G127 ▶

OVAL SPRAY

G-VL, GG-VL and HH-VL FullJet nozzles	G62 ▶	G128 ▶
---------------------------------------	-------	--------

HOLLOW CONE NOZZLES

	ENGLISH UNITS	METRIC UNITS
AX and BX WhirlJet® nozzles	G63 ▶	G129 ▶
CX WhirlJet nozzles	G64 ▶	G130 ▶
CF and E WhirlJet nozzles	G65 ▶	G131 ▶
BD WhirlJet nozzles	G68 ▶	G134 ▶
BSJ SpiralJet nozzles	G69 ▶	G135 ▶



PERFORMANCE DATA

FLAT SPRAY: 50070, 50085, 56780 AND 64010 NCJ CASTERJET® NOZZLES

Capacity Code	Assembly No.				Water 100 psi (gpm)	Air 45 psi (scfm)	Spray Angle
	50070	50085	64010	56780			
2	•		•	•	2.0	4.9	60° to 135°
2.5	•		•	•	2.5	5.6	
3	•				3.0	6.0	
3.5	•				3.5	9.8	
3.7	•		•	•	3.7	8.5	
4	•		•	•	4.0	9.9	
5	•				5.0	10.2	
5.7	•				5.7	12.7	
6.3	•				6.3	14.8	
6.5	•		•	•	6.5	15.5	
7			•	•	7.0	16.3	
8		•			8.0	18.0	
9		•			9.0	26.2	
10		•			10.0	23.7	
10.5		•			10.5	22.5	
12		•			12.0	23.0	

DIMENSIONS AND WEIGHTS

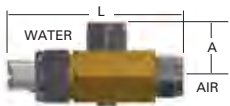
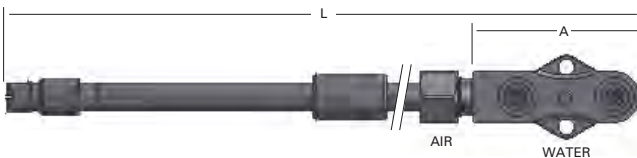
Nozzle	Nozzle Type	Air Inlet Conn. (in.)	Water Inlet Conn. (in.)	L (in.)	A (in.)
	50070	3/8 (F)	3/8 (F)	5.91 min.	1.36
	50085	1/2 (F)	1/2 (F)	8.69 min.	1.55
	64010	3/8 (F)	3/8 (F)	3.86	1.18
	56780	3/8 (F)	3/8 (F)	8.86	5.80

Length varies; other sizes are available. Available with NPT or BSPT threads unless otherwise noted.

PERFORMANCE DATA
FLAT SPRAY: D40208 CASTERJET® NOZZLES

Capacity Code	Assembly No.	Water 100 psi (gpm)	Air 45 psi (scfm)	Spray Angle
	D40208			
480	•	1.3	8.0	30° to 140°
490	•	1.3	5.2	
520	•	1.8	5.2	
530	•	2.2	4.1	
630	•	4.2	3.6	
640	•	3.7	3.9	
720	•	5.8	4.9	
770	•	7.3	7.1	
780	•	8.0	6.9	
850	•	10.3	7.2	

DIMENSIONS AND WEIGHTS

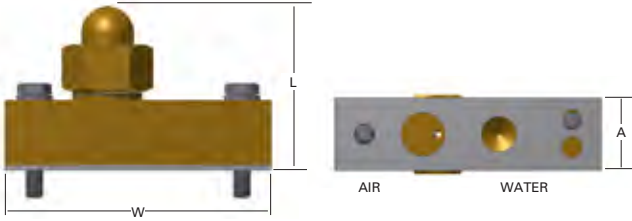
Nozzle	Nozzle Type	Air Conn. (in.)	Water Conn. (in.)	L (in.)	W (in.)	A (in.)
	D40208	.47	.59	2.11	3.58	.98

PERFORMANCE DATA
FLAT SPRAY: D41968 AND D41936 ANTI-PULSING CASTERJET® NOZZLES

Capacity Code	Assembly No.		Water 100 psi (gpm)	Air 45 psi (scfm)	Spray Angle
	D41968	D41936			
0.7	•	•	.8	.8	40° to 120°
1.3	•		1.3	1.7	
1.7	•		1.7	1.1	
2	•	•	1.9	2.6	
2.5	•		2.3	4.1	
2.7	•		2.4	6.9	
3	•	•	3.1	3.2	
3.5	•		3.3	3.7	
4	•		3.7	5.0	
4.5	•		4.2	4.7	
5	•		4.9	5.9	
6	•		5.7	4.2	
7.5	•	•	6.9	3.9	
8	•		6.9	3.9	

DIMENSIONS AND WEIGHTS

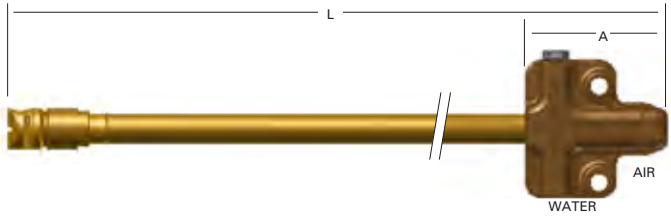
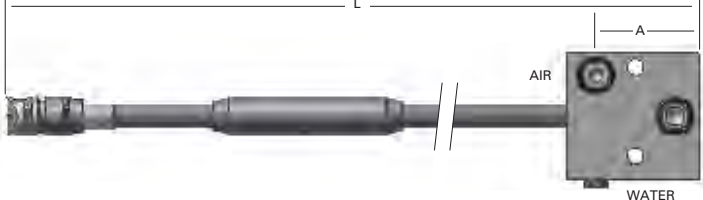
Nozzle	Nozzle Type	Air Conn. (in.)	Water Conn. (in.)	L (in.)	A (in.)
	D41968*	.31	.47	42.9 min.	3.27
	D41936*	.31	.47	54.53 min.	1.97

* Length varies.

PERFORMANCE DATA
FLAT SPRAY: 23530-XT AND 58090-XT VEEJET® NOZZLES

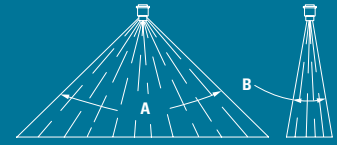

Nozzle Type	Capacity Size	Flow Rate Capacity (gallons per minute)							Spray Angle at 40 psi	
		10 psi	20 psi	40 psi	60 psi	80 psi	100 psi	200 psi	A	B
23530-XT	15	.8	1.1	1.5	1.8	2.1	2.4	3.4	105°	30°
	10	.5	.7	1.0	1.2	1.4	1.6	2.2	110°	30°
	20	1.0	1.4	2.0	2.4	2.8	3.2	4.5	110°	30°
58090-XT	20	1.0	1.4	2.0	2.4	2.8	3.2	4.5	45°	30°
	20	1.0	1.4	2.0	2.4	2.8	3.2	4.5	85°	30°
	26	1.3	1.8	2.6	3.2	3.7	4.1	5.8	85°	30°
	10	.5	.7	1.0	1.2	1.4	1.6	2.2	110°	30°
	15	.8	1.1	1.5	1.8	2.1	2.4	3.4	110°	30°
	20	1.0	1.4	2.0	2.4	2.8	3.2	4.5	110°	30°
	26	1.3	1.8	2.6	3.2	3.7	4.1	5.8	110°	30°
	40	2.0	2.8	4.0	4.9	5.7	6.3	8.9	110°	30°

DIMENSIONS AND WEIGHTS

Nozzle	Nozzle Type	Inlet Conn. (in.)	L (in.)	Hex. (in.)	D/flats (in.)
	58090-XT (M)	1/4	1.0	9/16	.63
		3/8	1.25	11/16	.75

Based on the largest/heaviest version of each type.

Nozzle	Nozzle Type	Inlet Conn. (in.)	L (in.)	Hex. (in.)	D/flats (in.)
	23530-XT (M)	3/8	1.27	11/16	.5

Based on the largest/heaviest version of each type.



**PERFORMANCE DATA
FLAT SPRAY: 56862 NOZZLES**

Nozzle Type	Inlet Conn. (in.)	Flow Rate Capacity (gallons per minute)							Spray Angle at 40 psi
		10 psi	20 psi	40 psi	60 psi	80 psi	100 psi	200 psi	
56862	1/2	1.1	1.5	2.2	2.6	3.0	3.4	4.8	20°

Dual heavy edge spray pattern enables each nozzle to cool two rolls.

DIMENSIONS AND WEIGHTS

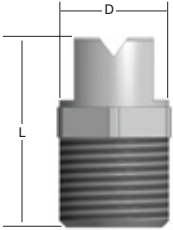
Nozzle	Nozzle Type	Inlet Conn. (in.)	L (in.)	Hex. (in.)	D/flats (in.)
	56862 (M)	1/2	1.5	7/8	.63

Based on the largest/heaviest version of each type.

**PERFORMANCE DATA
FLAT SPRAY: 49784-XT VEEJET® SPRAY TIPS**

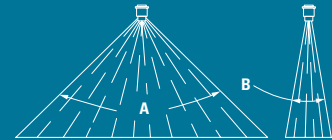

Tip Type	Capacity Size	Flow Rate Capacity (gallons per minute)						Spray Angle at 40 psi	
		20 psi	40 psi	60 psi	80 psi	100 psi	150 psi	A	B
•	20	1.41	2.00	2.45	2.83	3.16	3.87	65°, 80°	30°
•	30	2.12	3.00	3.67	4.25	4.74	5.80		
•	40	2.83	4.00	4.89	5.65	6.32	7.74		
•	50	3.53	5.00	6.12	7.07	7.90	9.68		
•	120	8.60	12.00	14.4	16.4	18.0	21.9	80°	

DIMENSIONS AND WEIGHTS

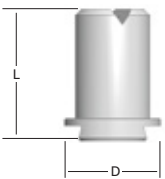
Spray Tip	Spray Tip Type	L (in.)	D (in.)
	49784-XT	1.50	.70

Based on the largest/heaviest version of each type.

PERFORMANCE DATA
FULL CONE: 58050 AND 58160 CASTERJET® NOZZLES

Capacity Code	Assembly No.		Water 100 psi (gpm)	Air 45 psi (scfm)	Spray Angle
	58050	58160			
075	•	•	.7	4.7	45°, 60°, 90°
090	•	•	.9	4.7	
095	•	•	.95	4.8	
210	•	•	2.1	10.0	

DIMENSIONS AND WEIGHTS

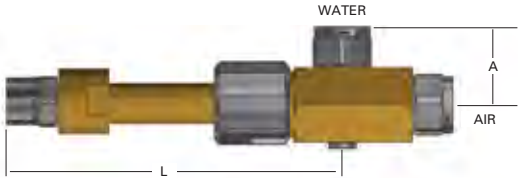
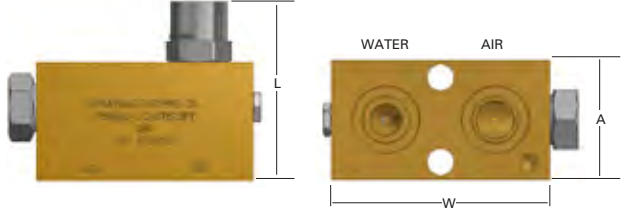
Nozzle	Nozzle Type	Air Conn. (in.)	Water Conn. (in.)	L (in.)	A (in.)	W (in.)
	58050	1/4 (F)	1/4 (F)	3.9 min.*	1.10	—
	58160	.39	.39	2.93	1.58	2.76

PERFORMANCE DATA
FULL CONE: D40206 CASTERJET® NOZZLES

Capacity Code	Assembly No.	Water 100 psi (gpm)	Air 45 psi (scfm)	Spray Angle
	D40206			
400	•	.6	8.4	60° to 90°
440	•	.7	8.7	
480	•	.9	8.1	
510	•	1.2	6.7	
520	•	1.7	3.7	
530	•	1.8	3.7	
560	•	2.3	4.9	
640	•	3.8	8.1	

DIMENSIONS AND WEIGHTS

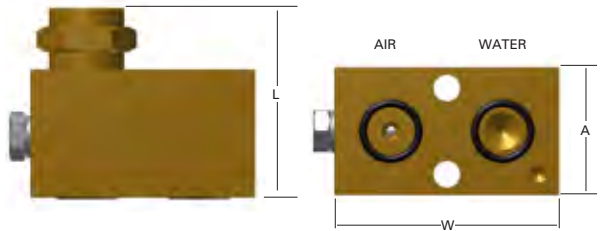
Nozzle	Nozzle Type	Air Conn. (in.)	Water Conn. (in.)	L (in.)	W (in.)	A (in.)
	D40206*	.39	.47	2.32	2.76	1.58

* Other sizes are available.

PERFORMANCE DATA
FULL CONE: HHCC FULLJET® NOZZLES

Inlet Conn. (in.)	Nozzle Type	Capacity Size	Orifice Dia. Nom. (in.)	Max. Free Passage Dia. (in.)	Flow Rate Capacity (gallons per minute)										Spray Angle at 40 psi
					10 psi	20 psi	30 psi	40 psi	50 psi	60 psi	70 psi	80 psi	90 psi	100 psi	
1/4	●	6.5	.085	.068	.65	.89	1.1	1.3	1.4	1.5	1.6	1.7	1.8	1.9	68°
	●	8	.088	.071	.80	1.1	1.3	1.5	1.7	1.8	2.0	2.1	2.2	2.3	
	●	10	.098	.072	1.0	1.4	1.7	1.9	2.2	2.4	2.5	2.7	2.8	3.0	74°
	●	12.5	.106	.075	1.25	1.7	2.1	2.4	2.7	2.9	3.1	3.3	3.5	3.7	
3/8	●	15	.128	.085	1.5	2.1	2.5	2.9	3.2	3.5	3.7	4.0	4.2	4.4	
1/2	●	20	.111	.101	2.0	2.8	3.4	3.8	4.3	4.6	5.0	5.3	5.6	5.8	74°
	●	25	.119	.115	2.5	3.5	4.2	4.8	5.3	5.8	6.2	6.6	7.0	7.3	
	●	32	.170	.120	3.2	4.5	5.4	6.1	6.8	7.4	7.9	8.4	8.9	9.4	

DIMENSIONS AND WEIGHTS

Nozzle	Nozzle Type	Inlet Conn. (in.)	L (in.)	Hex. (in.)
	HHCC (M)	1/4	.875	9/16
		3/8	.938	11/16
		1/2	1.16	7/8

Based on the largest/heaviest version of each type.

PERFORMANCE DATA
FULL CONE: HHX FULLJET® NOZZLES

Inlet Conn. (in.)	Nozzle Type	Capacity Size	Orifice Dia. Nom. (in.)	Max. Free Passage Dia. (in.)	Flow Rate Capacity (gallons per minute)										Spray Angle (°)		
					5 psi	7 psi	10 psi	20 psi	30 psi	40 psi	60 psi	80 psi	100 psi	150 psi	7 psi	20 psi	80 psi
1/4	●	5	.078	.046	.36	.42	.50	.69	.82	.95	1.2	1.3	1.5	1.8	60	65	61
	●	6.5	.093	.062	.47	.55	.65	.89	1.1	1.3	1.5	1.7	1.9	2.3	45	50	46
	●	8	.109	.046	.58	.68	.80	1.1	1.3	1.5	1.8	2.1	2.3	2.8	68	80	76
	●	10	.109	.062	.73	.85	1.0	1.4	1.7	1.9	2.4	2.7	3.0	3.6	58	67	61
	●	12	.125	.062	.87	1.0	1.2	1.7	2.0	2.3	2.7	3.1	3.5	4.2	71	81	72
	●	14.5	.140	.062	1.05	1.2	1.45	2.0	2.4	2.7	3.3	3.8	4.2	5.0	78	89	75
3/8	●	15	.140	.093	1.1	1.3	1.5	2.1	2.5	2.9	3.5	4.0	4.4	5.3	64	67	61
	●	18	.156	.093	1.3	1.5	1.8	2.5	3.0	3.4	4.1	4.7	5.2	6.3	77	86	73
	●	20	.171	.109	1.5	1.7	2.0	2.8	3.4	3.8	4.6	5.3	5.9	7.0	76	80	73
	●	22	.187	.109	1.6	1.9	2.2	3.0	3.7	4.2	5.1	5.8	6.4	7.8	87	90	82

DIMENSIONS AND WEIGHTS

Nozzle	Nozzle Type	Inlet Conn. (in.)	L (in.)	Hex. (in.)
	HHX (M)	1/4	.875	9/16
		3/8	.938	11/16

Based on the largest/heaviest version of each type.



PERFORMANCE DATA
FULL CONE: P45075 FULLJET® NOZZLES

Inlet Conn. (in.)	Nozzle Type P45075	Capacity Size	Orifice Dia. Nom. (in.)	Max. Free Passage Dia. (in.)	Flow Rate Capacity (gallons per minute)							Spray Angle at 20 psi
					10 psi	20 psi	30 psi	40 psi	60 psi	80 psi	100 psi	
1/4	•	4	.076	.047	.42	.57	.70	.81	.96	1.1	1.2	65°
	•	5.5	.084	.050	.56	.78	.96	1.1	1.3	1.5	1.6	
	•	7.5	.099	.050	.77	1.1	1.3	1.5	1.8	2.0	2.2	45°, 65°
3/8	•	3	.060	.040	.28	.39	.48	.55	.61	.71	.79	65°
	•	3.5	.065	.047	.35	.48	.58	.66	.80	.91	1.0	
	•	4	.072	.047	.42	.57	.70	.81	.96	1.1	1.2	
	•	5	.081	.063	.46	.65	.80	.93	1.1	1.3	1.5	
	•	5.5	.084	.050	.56	.78	.96	1.1	1.3	1.5	1.6	
	•	7	.094	.050	.70	.96	1.2	1.3	1.6	1.8	2.0	45°, 65°
	•	8.5	.103	.063	.85	1.2	1.5	1.7	2.0	2.2	2.5	65°
	•	10	.109	.063	.94	1.3	1.6	1.9	2.2	2.5	2.7	45°, 65°
	•	11	.112	.063	1.1	1.5	1.8	2.1	2.5	2.9	3.2	
	•	14	.136	.093	1.43	2.0	2.4	2.7	3.3	3.7	4.1	60°
	•	22	.166	.118	2.2	3.0	3.5	3.9	4.6	5.1	5.6	60°, 90°
	•	7W	.086	.050	.70	.90	1.0	1.1	1.3	1.5	1.6	120°

DIMENSIONS AND WEIGHTS

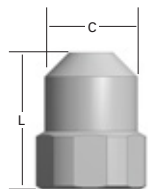
Nozzle	Nozzle Type	Inlet Conn. (in.)	L (in.)	Hex. (in.)	C (in.)	Net Weight (oz.)
	P45075 (F)	1/4	1.09	13/16	.75	1.9
		3/8	1.05	7/8	.83	1.9

Based on the largest/heaviest version of each type.

PERFORMANCE DATA
RECTANGULAR SPRAY: D41502 CASTERJET® NOZZLES

Capacity Code	Assembly No.	Water 100 psi (gpm)	Air 45 psi (scfm)	Spray Angle
	D41502			
450	•	.8	5.2	70° to 120°
510	•	1.2	7.9	
520	•	1.2	3.2	
540	•	2.0	5.2	
600	•	2.8	4.6	
610	•	3.2	4.0	

DIMENSIONS AND WEIGHTS

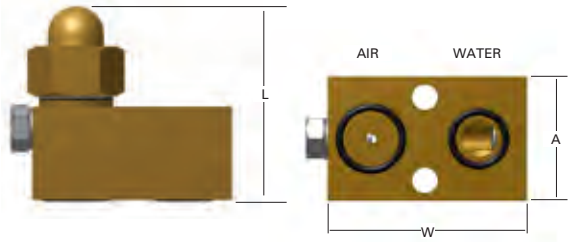
Nozzle	Nozzle Type	Air Conn. (in.)	Water Conn. (in.)	L (in.)	W (in.)	A (in.)
	D41502*	.47	.59	2.09	2.52	1.58

* Other sizes are available.

PERFORMANCE DATA
RECTANGULAR SPRAY: 25381 AND D41828 SPRAY TIPS

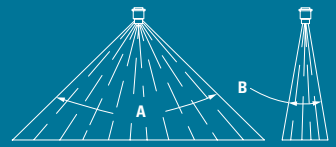

Nozzle Type		Capacity Size	Flow Rate Capacity (gallons per minute)					Spray Angle at 40 psi	
25381	D41828		20 psi	40 psi	70 psi	100 psi	200 psi	A	B
•	•	6	.44	.59	.75	.88	1.3	90° 70°	20°
•	•	8	.58	.78	.99	1.2	1.6	90° 70°	20°
•	•	9	.65	.89	1.2	1.6	1.75	90° 70°	20°
•	•	13	.90	1.3	1.7	1.85	2.4	90° 70° 70°	20° 30° 20°
•	•	14	1.1	1.5	1.8	2.1	2.9	90° 70° 70°	20° 30° 20°
•	•	19	1.4	1.8	2.5	2.8	3.9	90° 70°	20°
•	•	21	1.6	2.1	2.7	3.2	4.5	90° 70° 70°	20° 30° 20°
•	•	28	1.9	2.6	3.6	4.2	5.9	90° 70° 70°	20° 30° 20°
•	•	35	2.5	3.5	4.5	5.2	7.2	90° 70° 70°	20° 30° 20°
•	•	46	3.4	4.6	5.9	6.9	9.0	90° 70° 70°	20° 30° 20°
•	•	61	4.5	6.1	7.9	9.0	12.5	90° 70° 70°	20° 30° 20°
•	•	100	7.3	10.0	14.0	15.5	20.1	90° 70° 70°	20° 30° 20°

DIMENSIONS AND WEIGHTS

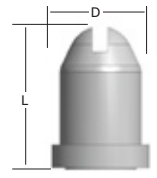
Nozzle	Nozzle Type	L (in.)	D (in.)	Net Weight (oz.)
	25381	1.378	.945	2.1

Based on the largest/heaviest version of each type.

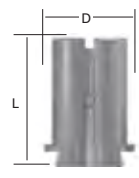
Nozzle	Nozzle Type	L (in.)	D (in.)	Net Weight (oz.)
	D41828	1.34	.79	3.0

Based on the largest/heaviest version of each type.

PERFORMANCE DATA
RECTANGULAR SPRAY: D41539 SPRAY TIPS

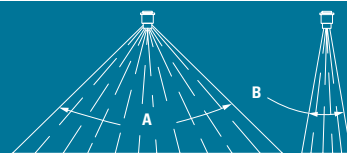

Spray Tip Type	Capacity Size	Flow Rate Capacity (gallons per minute)						Spray Angle at 40 psi	
		20 psi	40 psi	60 psi	80 psi	100 psi	150 psi	A	B
D41539									
•	6	1.1	1.6	2.0	2.3	2.5	3.1	80°	24°
•	8	1.5	2.1	2.6	3.0	3.3	4.1		
•	12	2.3	3.2	3.9	4.5	5.1	6.2		
•	18	3.3	4.7	5.8	6.6	7.4	9.1		32°

DIMENSIONS AND WEIGHTS

Nozzle	Spray Tip Type	L (in.)	D1 (in.)	D2 (in.)	D3 (in.)
<p>The technical drawing shows a cylindrical nozzle with a central spray tip. Dimension D1 is the diameter of the spray tip, D2 is the diameter of the nozzle body, D3 is the diameter of the nozzle base, and L is the length of the nozzle body.</p>	D41539	2.05	1.26	1.5	1.34

PERFORMANCE DATA
IMPINGEMENT COOLING: 26010-1/4J NOZZLES

Nozzle Type	Capacity Size*	Pressure (psi)		Flow Rate Capacity		Spray Angle
		Air	Liquid	Air (scfm)	Liquid (gpm)	
26010-1/4J						
•	0	40	37	3.0	.5	90°
•	1		33	9.7	1.0	
•	2		35	10.5	1.5	
•	3		60	6.2	2.8	
•	4		35	10.5	1.5	120°
•	5		60	5.5	2.8	

* Number of indicator rings on the air cap.

DIMENSIONS AND WEIGHTS

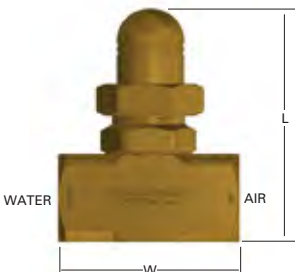
Nozzle	Nozzle Type	Air Conn. (in.)	Water Conn (in.)	L (in.)	W (in.)
	26010-1/4J	1/4	1/4	2.38	1.5



PERFORMANCE DATA
OVERVIEW

Nozzle Type								Capacity Code	Flow Rate Capacity (gallons per minute)								
AA214 Compact	DescalJet® Pro	Mini DescalJet Pro	26180/26190	AA218/AA219	HiScaleJet	HSJ	Mini HiScaleJet		1000 psi	1500 psi	2000 psi	2500 psi	3000 psi	3500 psi	4000 psi	4500 psi	5000 psi
•								-02	1.0	1.2	1.4	1.6	1.7	1.9	2.0	2.1	2.2
•								-03	1.5	1.8	2.1	2.4	2.6	2.8	3.0	3.2	3.4
•								-04	2.0	2.4	2.8	3.2	3.5	3.7	4.0	4.2	4.5
•		•						-05	2.5	3.1	3.5	4.0	4.3	4.7	5.0	5.3	5.6
•		•					•	-06	3.0	3.7	4.2	4.7	5.2	5.6	6.0	6.4	6.7
•		•					•	-07	3.5	4.3	4.9	5.5	6.1	6.5	7.0	7.4	7.8
•	•	•	•	•	•	•	•	-08	4.0	4.9	5.7	6.3	6.9	7.5	8.0	8.5	8.9
•	•	•	•	•	•	•	•	-09	4.5	5.5	6.4	7.1	7.8	8.4	9.0	9.5	10.1
•	•	•	•	•	•	•	•	-10	5.0	6.1	7.1	7.9	8.7	9.4	10.0	10.6	11.2
•	•	•	•	•	•	•	•	-12	6.0	7.3	8.5	9.5	10.4	11.2	12.0	12.7	13.4
•	•	•	•	•	•	•	•	-15	7.5	9.2	10.6	11.9	13.0	14.0	15.0	15.9	16.8
	•	•	•	•	•	•	•	-20	10.0	12.2	14.1	15.8	17.3	18.7	20	21	22
	•	•	•	•	•	•	•	-25	12.5	15.3	17.7	19.8	22	23	25	27	28
	•	•	•	•	•	•	•	-30	15.0	18.4	21	24	26	28	30	32	34
	•	•	•	•	•	•	•	-35	17.5	21	25	28	30	33	35	37	39
	•	•	•	•	•	•	•	-40	20	24	28	32	35	37	40	42	45
	•	•	•	•	•	•	•	-50	25	31	35	40	43	47	50	53	56
	•	•	•	•	•	•	•	-55	28	34	39	43	48	51	55	58	61
	•	•	•	•	•	•	•	-60	30	37	42	47	52	56	60	64	67
	•	•	•	•	•	•	•	-70	35	43	49	55	61	65	70	74	78

DIMENSIONS AND WEIGHTS

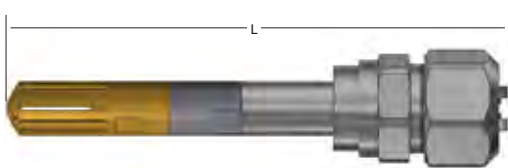
Nozzle	Nozzle Type	Inlet Conn.	L (in.)
	DescalJet® Pro Nozzles	Available with weld or 1" (M) threaded connection adapters; some styles use a high impact strainer attachment, with or without body adapter for added length. Mini configuration also available. Projection into header varies by connection.	Minimum overall length: 5.59 Maximum length: 7.48 Mini DescalJet Pro nozzle length: 6.12 Nozzles can be ordered in any length between the minimum and maximum. Longer lengths are available upon request.

Dimensions vary depending on the capacity, configuration and options selected. Contact your local sales engineer to request dimensional data for other descaling nozzle types.

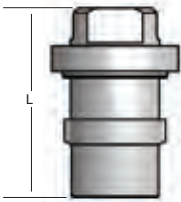
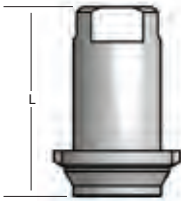
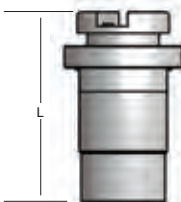

DIMENSIONS AND WEIGHTS

DescalJet® Pro Tip Body	Assembly No.	L (in.)	Diameter (in.)
	98016-1-SS	1.87	1.25
	98016-2-SS	1.87	1.12
	98016-3-SS	1.87	1.16

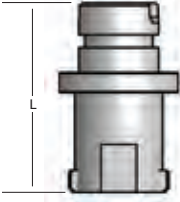
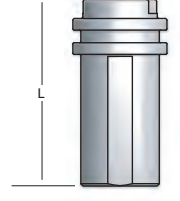
DescalJet Pro Tip Body	Assembly No.	L (in.)	Diameter (in.)
	98016-4-SS	1.87	1.18
	98016-5-SS	1.87	.94

For complete information, contact your local sales engineer.

ENGLISH UNITS

DIMENSIONS AND WEIGHTS

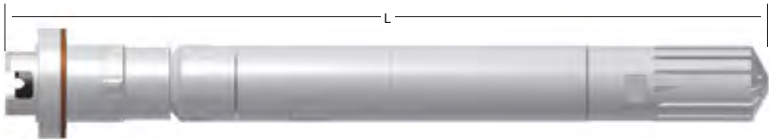
CVCN Check Valves	Nozzle Type	L (in.)
 <p>CVCN check valves in varying lengths to fit existing DescaleJet Pro nozzles.</p>	DescalJet Pro with CVCN	8.1 to 11.2

For complete information, contact your local sales engineer.

PERFORMANCE DATA

ENGLISH UNITS
FLAT SPRAY NOZZLES

ENGLISH UNITS

PERFORMANCE DATA
H-VV, H-VVL AND H-DT VEEJET® NOZZLES

Spray Angle at 40 psi	Nozzle Type/ Inlet Conn. (in.)						Capacity Size	Equiv. Orifice Dia. (in.)	Flow Rate Capacity (gallons per minute)										Spray Angle (°)			
	H-VV		H-VVL		H-DT				5 psi	10 psi	20 psi	40 psi	80 psi	100 psi	200 psi	300 psi	500 psi	20 psi	40 psi	80 psi	200 psi	
	1/8	1/4	1/8	1/4	1/8	1/4																
110°	•	•	•	•			01	.026	.035	.05	.07	.10	.14	.16	.22	.27	.35	94	110	121	124	
	•	•	•	•			015	.032	.05	.08	.11	.15	.21	.24	.34	.41	.53	97	110	121	124	
	•	•	•	•		•	02	.035	.07	.10	.14	.20	.28	.32	.45	.55	.71	98	110	120	123	
	•	•	•	•		•	03	.043	.11	.15	.21	.30	.42	.47	.67	.82	1.1	99	110	120	123	
	•	•	•	•		•	04	.050	.14	.20	.28	.40	.57	.63	.89	1.1	1.4	100	110	119	122	
	•	•	•	•		•	05	.056	.18	.25	.35	.50	.71	.79	1.1	1.4	1.8	100	110	118	122	
	•	•	•	•		•	06	.061	.21	.30	.42	.60	.85	.95	1.3	1.6	2.1	101	110	117	122	
	•	•	•	•		•	08	.071	.28	.40	.57	.80	1.1	1.3	1.8	2.2	2.8	102	110	117	121	
	•	•	•	•		•	10	.079	.35	.50	.71	1.0	1.4	1.6	2.2	2.7	3.5	103	110	117	119	
	•	•	•	•		•	15	.094	.53	.75	1.1	1.5	2.1	2.4	3.4	4.1	5.3	104	110	117	118	
95°	•		•			•	0050	.018	–	–	.035	.050	.07	.08	.11	.14	.18	81	95	105	113	
	•	•	•	•			01	.026	.035	.05	.07	.10	.14	.16	.22	.27	.35	81	95	105	113	
	•		•	•			015	.032	.05	.08	.11	.15	.21	.24	.34	.41	.53	82	95	105	113	
	•	•	•	•		•	02	.035	.07	.10	.14	.20	.28	.32	.45	.55	.71	82	95	105	113	
	•	•	•	•		•	03	.043	.11	.15	.21	.30	.42	.47	.67	.82	1.1	83	95	104	111	
	•	•	•	•		•	04	.050	.14	.20	.28	.40	.57	.63	.89	1.1	1.4	84	95	103	108	
	•	•	•	•		•	05	.056	.18	.25	.35	.50	.71	.79	1.1	1.4	1.8	84	95	102	107	
	•	•	•	•		•	06	.061	.21	.30	.42	.60	.85	.95	1.3	1.6	2.1	86	95	101	106	
	•		•	•		•	065	.064	.23	.33	.46	.65	.92	1.0	1.5	1.8	2.3	86	95	101	106	
80°	•	•	•	•			0050	.018	–	–	.035	.050	.07	.08	.11	.14	.18	61	80	95	101	
	•	•	•	•			0067	.021	–	.033	.05	.067	.09	.11	.15	.18	.24	67	80	94	99	
	•	•	•	•		•	01	.026	–	.05	.07	.10	.14	.16	.22	.27	.35	68	80	89	92	
		•	•	•		•	015	.032	–	.08	.11	.15	.21	.24	.34	.41	.53	68	80	89	92	
	•	•	•	•		•	02	.035	.07	.10	.14	.20	.28	.32	.45	.55	.71	69	80	88	91	
	•	•	•	•		•	03	.043	.11	.15	.21	.30	.42	.47	.67	.82	1.1	70	80	87	90	
	•	•	•	•		•	04	.050	.14	.20	.28	.40	.57	.63	.89	1.1	1.4	71	80	86	89	
	•	•	•	•		•	05	.056	.18	.25	.35	.50	.71	.79	1.1	1.4	1.8	71	80	86	89	
	•	•	•	•		•	06	.061	.21	.30	.42	.60	.85	.95	1.3	1.6	2.1	72	80	85	88	
	•		•	•		•	07	.066	.25	.35	.49	.70	.99	1.1	1.6	1.9	2.5	72	80	85	88	
	•	•	•	•		•	08	.071	.28	.40	.57	.80	1.1	1.3	1.8	2.2	2.8	72	80	84	87	
		•		•		•	09	.075	.32	.45	.64	.90	1.3	1.4	2.0	2.5	3.2	73	80	84	87	

Highlighted column shows the rated pressure.



PERFORMANCE DATA
H-VV, H-VVL AND H-DT VEEJET® NOZZLES

Spray Angle at 40 psi	Nozzle Type/ Inlet Conn. (in.)						Capacity Size	Equiv. Orifice Dia. (in.)	Flow Rate Capacity (gallons per minute)										Spray Angle (°)			
	H-VV		H-VVL		H-DT				5 psi	10 psi	20 psi	40 psi	80 psi	100 psi	200 psi	300 psi	500 psi	20 psi	40 psi	80 psi	200 psi	
	1/8	1/4	1/8	1/4	1/8	1/4																
73°	●	●	●	●	●		0077	.023	–	.039	.055	.077	.11	.12	.17	.21	.27	53	73	86	92	
	●	●	●	●			0154	.032	.054	.077	.11	.15	.22	.24	.34	.42	.54	55	73	84	88	
		●		●			0231	.038	.082	.12	.16	.23	.33	.37	.52	.63	.82	56	73	83	87	
	●	●	●	●			0308	.044	.11	.15	.22	.31	.44	.49	.69	.84	1.1	58	73	82	86	
		●		●			0462	.054	.16	.23	.33	.46	.65	.73	1.0	1.3	1.6	60	73	80	84	
	●		●				0770	.069	.27	.39	.54	.77	1.1	1.2	1.7	2.1	2.7	64	73	77	82	
65°	●		●				0017	.011	–	–	.012	.017	.024	.027	.038	.047	.06	44	65	77	86	
	●		●				0033	.015	–	–	.023	.033	.047	.052	.07	.09	.12	47	65	76	83	
	●	●	●	●	●		0067	.021	–	.033	.05	.067	.09	.11	.15	.18	.24	50	65	75	81	
	●	●	●	●	●	●	01	.026	–	.05	.07	.10	.14	.16	.22	.27	.35	51	65	74	80	
	●	●	●	●			015	.032	–	.08	.11	.15	.21	.24	.34	.41	.53	51	65	74	80	
	●	●	●	●	●	●	02	.035	.07	.10	.14	.20	.28	.32	.45	.55	.71	52	65	73	79	
	●		●				025	.039	.09	.13	.18	.25	.35	.40	.56	.68	.88	52	65	73	79	
	●	●	●	●	●	●	03	.043	.11	.15	.21	.30	.42	.47	.67	.82	1.1	53	65	72	78	
	●	●	●	●	●	●	04	.050	.14	.20	.28	.40	.57	.63	.89	1.1	1.4	53	65	72	76	
	●	●	●	●	●	●	05	.056	.18	.25	.35	.50	.71	.79	1.1	1.4	1.8	53	65	72	76	
		●			●	●	055	.059	.19	.28	.39	.55	.78	.87	1.2	1.5	1.9	53	65	72	76	
	●	●		●	●	●	06	.061	.21	.30	.42	.60	.85	.95	1.3	1.6	2.1	54	65	72	75	
		●			●	●	07	.066	.25	.35	.49	.70	.99	1.1	1.6	1.9	2.5	54	65	71	75	
	●	●	●	●	●	●	08	.071	.28	.40	.57	.80	1.1	1.3	1.8	2.2	2.8	55	65	71	74	
	●				●	●	09	.075	.32	.45	.64	.90	1.3	1.4	2.0	2.5	3.2	55	65	71	74	
50°	●	●	●	●			01	.026	–	.05	.07	.10	.14	.16	.22	.27	.35	37	50	59	65	
	●	●	●	●			02	.035	–	.10	.14	.20	.28	.32	.45	.55	.71	39	50	57	63	
	●	●	●	●		●	03	.043	.11	.15	.21	.30	.42	.47	.67	.82	1.1	40	50	56	62	
	●	●	●	●		●	04	.050	.14	.20	.28	.40	.57	.63	.89	1.1	1.4	42	50	56	61	
	●	●	●	●		●	05	.056	.18	.25	.35	.50	.71	.79	1.1	1.4	1.8	44	50	56	61	
	●				●		055	.059	.19	.28	.39	.55	.78	.87	1.2	1.5	1.9	44	50	56	61	
	●	●	●	●		●	06	.061	.21	.30	.42	.60	.85	.95	1.3	1.6	2.1	45	50	56	60	
	●	●			●		07	.066	.25	.35	.49	.70	.99	1.1	1.6	1.9	2.5	45	50	56	60	
	●	●	●	●		●	08	.071	.28	.40	.57	.80	1.1	1.3	1.8	2.2	2.8	45	50	55	60	
		●			●	●	09	.075	.32	.45	.64	.90	1.3	1.4	2.0	2.5	3.2	45	50	55	59	
40°	●	●	●	●	●		01	.026	–	–	.07	.10	.14	.16	.22	.27	.35	26	40	52	59	
	●	●	●	●	●		015	.032	–	–	.11	.15	.21	.24	.34	.41	.53	27	40	52	59	
	●	●	●	●	●	●	02	.035	–	.10	.14	.20	.28	.32	.45	.55	.71	29	40	51	58	
	●	●	●	●	●	●	03	.043	–	.15	.21	.30	.42	.47	.67	.82	1.1	30	40	50	57	
	●	●	●	●	●	●	04	.050	–	.20	.28	.40	.57	.63	.89	1.1	1.4	30	40	50	56	

Highlighted column shows the rated pressure.



PERFORMANCE DATA

**ENGLISH UNITS
FLAT SPRAY NOZZLES**

ENGLISH UNITS

**PERFORMANCE DATA
H-VV, H-VVL AND H-DT VEEJET® NOZZLES**

Spray Angle at 40 psi	Nozzle Type/ Inlet Conn. (in.)						Capacity Size	Equiv. Orifice Dia. (in.)	Flow Rate Capacity (gallons per minute)										Spray Angle (°)			
	H-VV		H-VVL		H-DT				5 psi	10 psi	20 psi	40 psi	80 psi	100 psi	200 psi	300 psi	500 psi	20 psi	40 psi	80 psi	200 psi	
	1/8	1/4	1/8	1/4	1/8	1/4																
40°	•	•	•	•	•	•	05	.056	–	.25	.35	.50	.71	.79	1.1	1.4	1.8	31	40	49	55	
	•	•			•	•	055	.059	–	.28	.39	.55	.78	.87	1.2	1.5	1.9	31	40	49	55	
	•	•	•	•	•	•	06	.061	–	.30	.42	.60	.85	.95	1.3	1.6	2.1	31	40	49	55	
	•	•			•	•	065	.064	–	.33	.46	.65	.92	1.0	1.5	1.8	2.3	31	40	48	54	
	•	•			•	•	07	.066	–	.35	.49	.70	.99	1.1	1.6	1.9	2.5	31	40	48	54	
	•	•	•	•	•	•	08	.071	.28	.40	.57	.80	1.1	1.3	1.8	2.2	2.8	31	40	47	53	
	•						085	.073	.30	.43	.60	.85	1.2	1.3	1.9	2.3	3.0	32	40	46	50	
	•	•			•	•	09	.075	.32	.45	.64	.90	1.3	1.4	2.0	2.5	3.2	32	40	46	50	
25°	•	•	•	•	•		01	.026	–	–	.07	.10	.14	.16	.22	.27	.35	14	25	34	42	
	•	•	•	•	•	•	02	.035	–	–	.14	.20	.28	.32	.45	.55	.71	15	25	33	40	
	•	•	•	•	•	•	03	.043	–	–	.21	.30	.42	.47	.67	.82	1.1	15	25	33	40	
	•	•	•	•	•	•	04	.050	–	.20	.28	.40	.57	.63	.89	1.1	1.4	1.6	16	25	32	39
				•	•	•	045	.053	–	.23	.32	.45	.64	.71	1.0	1.2	1.6	16	25	32	39	
	•	•	•	•	•	•	05	.056	–	.25	.35	.50	.71	.79	1.1	1.4	1.8	16	25	32	39	
	•	•			•	•	055	.059	–	.28	.39	.55	.78	.87	1.2	1.5	1.9	16	25	31	38	
	•	•	•	•	•	•	06	.061	–	.30	.42	.60	.85	.95	1.3	1.6	2.1	17	25	31	38	
	•	•			•	•	065	.064	–	.33	.46	.65	.92	1.0	1.5	1.8	2.3	17	25	31	38	
	•	•	•		•	•	07	.066	–	.35	.49	.70	.99	1.1	1.6	1.9	2.5	17	25	31	38	
	•	•					075	.068	–	.38	.53	.75	1.1	1.2	1.7	2.1	2.7	17	25	31	38	
	•	•	•	•	•	•	08	.071	–	.40	.57	.80	1.1	1.3	1.8	2.2	2.8	17	25	31	38	
	•						085	.073	–	.43	.60	.85	1.2	1.3	1.9	2.3	3.0	18	25	31	37	
	•	•			•	•	09	.075	–	.45	.64	.90	1.3	1.4	2.0	2.5	3.2	17	25	31	37	
					•		15	.094	–	.75	1.1	1.5	2.1	2.4	3.4	4.1	5.3	18	25	31	37	
15°	•	•		•			01	.026	–	–	–	.10	.14	.16	.22	.27	.35	–	15	24	28	
	•		•		•	•	02	.035	–	–	.14	.20	.28	.32	.45	.55	.71	6	15	22	27	
	•	•	•	•	•	•	03	.043	–	–	.21	.30	.42	.47	.67	.82	1.1	6	15	22	27	
	•	•	•	•	•	•	04	.050	–	–	.28	.40	.57	.63	.89	1.1	1.4	7	15	21	26	
	•	•	•	•	•	•	05	.056	–	–	.35	.50	.71	.79	1.1	1.4	1.8	7	15	21	26	
	•	•			•	•	055	.059	–	.28	.39	.55	.78	.87	1.2	1.5	1.9	7	15	21	26	
	•	•	•	•	•	•	06	.061	–	.30	.42	.60	.85	.95	1.3	1.6	2.1	8	15	21	26	
	•	•			•	•	065	.064	–	.33	.46	.65	.92	1.0	1.5	1.8	2.3	8	15	20	25	
		•			•	•	07	.066	–	.35	.49	.70	.99	1.1	1.6	1.9	2.5	8	15	20	25	
	•	•	•	•	•	•	08	.071	–	.40	.57	.80	1.1	1.3	1.8	2.2	2.8	9	15	20	25	
	•	•			•	•	085	.073	–	.43	.60	.85	1.2	1.3	1.9	2.3	3.0	9	15	19	24	
	•	•			•	•	09	.075	–	.45	.64	.90	1.3	1.4	2.0	2.5	3.2	9	15	19	24	

Highlighted column shows the rated pressure.



**PERFORMANCE DATA
H-U, H-DU AND U VEEJET® NOZZLES**

Spray Angle at 40 psi	Nozzle Type/ Inlet Conn. (in.)										Capacity Size	Equiv. Orifice Dia. (in.)	Flow Rate Capacity (gallons per minute)										Spray Angle (°)			
	H-U					H-DU		U					5 psi	10 psi	20 psi	40 psi	80 psi	100 psi	200 psi	300 psi	500 psi	20 psi	40 psi	80 psi	200 psi	
	1/8	1/4	3/8	1/2	3/4	1/8	1/4	1	1-1/4	2																
110°		•									20	.109	.71	1.0	1.4	2.0	2.8	3.2	4.5	5.5	7.1	105	110	117	118	
95°	•	•		•		•	•				10	.079	.35	.50	.71	1.0	1.4	1.6	2.2	2.7	3.5	89	95	100	105	
	•	•		•		•	•				15	.094	.53	.75	1.1	1.5	2.1	2.4	3.4	4.1	5.3	90	95	100	105	
	•	•	•				•				20	.109	.71	1.0	1.4	2.0	2.8	3.2	4.5	5.5	7.1	90	95	100	105	
	•	•		•		•	•				30	.133	1.1	1.5	2.1	3.0	4.2	4.7	6.7	8.2	10.6	91	95	101	105	
		•	•	•			•				40	.153	1.4	2.0	2.8	4.0	5.7	6.3	8.9	11.0	14.1	92	95	100	105	
		•		•			•				50	.172	1.8	2.5	3.5	5.0	7.1	7.9	11.2	13.7	17.7	93	95	99	103	
		•		•			•				60	.188	2.1	3.0	4.2	6.0	8.5	9.5	13.4	16.4	21	93	95	99	103	
		•	•	•				•			70	.203	2.5	3.5	4.9	7.0	9.9	11.1	15.7	19.2	25	93	95	99	103	
				•							80	.217	2.8	4.0	5.7	8.0	11.3	12.6	17.9	22	28	93	95	99	102	
				•							100	.243	3.5	5.0	7.1	10.0	14.1	15.8	22	27	35	93	95	99	102	
			•							150	.297	5.3	7.5	10.6	15.0	21	24	34	41	53	93	95	99	102		
				•						400	.472	14.1	20	28	40	57	63	89	110	141	93	95	99	102		
80°	•	•	•	•		•	•				10	.079	.35	.50	.71	1.0	1.4	1.6	2.2	2.7	3.5	73	80	84	87	
	•	•		•		•	•				15	.094	.53	.75	1.1	1.5	2.1	2.4	3.4	4.1	5.3	74	80	83	86	
	•	•	•	•		•	•				20	.109	.71	1.0	1.4	2.0	2.8	3.2	4.5	5.5	7.1	74	80	83	86	
	•	•	•	•		•	•				30	.133	1.1	1.5	2.1	3.0	4.2	4.7	6.7	8.2	10.6	74	80	83	86	
	•	•	•	•		•	•				40	.153	1.4	2.0	2.8	4.0	5.7	6.3	8.9	11.0	14.1	74	80	83	86	
		•	•	•			•				50	.172	1.8	2.5	3.5	5.0	7.1	7.9	11.2	13.7	17.7	74	80	83	85	
		•	•	•			•				60	.188	2.1	3.0	4.2	6.0	8.5	9.5	13.4	16.4	21	75	80	83	85	
		•	•	•			•				70	.203	2.5	3.5	4.9	7.0	9.9	11.1	15.7	19.2	25	75	80	83	86	
			•	•							100	.243	3.5	5.0	7.1	10.0	14.1	15.8	22	27	35	75	80	83	86	
			•	•							150	.297	5.3	7.5	10.6	15.0	21	24	34	41	53	73	80	84	86	
				•	•						200	.343	7.1	10.0	14.1	20	28	32	45	55	71	74	80	82	85	
				•							400	.472	14.1	20	28	40	57	63	89	110	141	78	80	81	83	
									•		500	.528	17.7	25	35	50	71	79	112	137	177	78	80	81	83	
								•		580	.569	21	29	41	58	82	92	130	159	205	78	80	81	83		
65°	•	•	•			•	•				10	.079	.35	.50	.71	1.0	1.4	1.6	2.2	2.7	3.5	56	65	71	74	
	•	•									12	.084	.42	.60	.85	1.2	1.7	1.9	2.7	3.3	4.2	56	65	71	73	
	•	•	•	•		•	•				15	.094	.53	.75	1.1	1.5	2.1	2.4	3.4	4.1	5.3	56	65	70	73	
	•	•		•		•	•				20	.109	.71	1.0	1.4	2.0	2.8	3.2	4.5	5.5	7.1	57	65	70	73	
	•										25	.121	.88	1.3	1.8	2.5	3.5	4.0	5.6	6.8	8.8	57	65	69	73	
	•	•	•			•	•				30	.133	1.1	1.5	2.1	3.0	4.2	4.7	6.7	8.2	10.6	58	65	69	72	
	•	•	•			•	•				40	.153	1.4	2.0	2.8	4.0	5.7	6.3	8.9	11.0	14.1	59	65	68	72	
	•	•	•	•			•				50	.172	1.8	2.5	3.5	5.0	7.1	7.9	11.2	13.7	17.7	60	65	68	71	
		•	•	•			•				60	.188	2.1	3.0	4.2	6.0	8.5	9.5	13.4	16.4	21	60	65	68	71	

Highlighted column shows the rated pressure.



PERFORMANCE DATA

ENGLISH UNITS
FLAT SPRAY NOZZLES

ENGLISH UNITS

PERFORMANCE DATA
H-U, H-DU AND U VEEJET® NOZZLES

Spray Angle at 40 psi	Nozzle Type/ Inlet Conn. (in.)										Capacity Size	Equiv. Orifice Dia. (in.)	Flow Rate Capacity (gallons per minute)										Spray Angle (°)			
	H-U					H-DU		U					5 psi	10 psi	20 psi	40 psi	80 psi	100 psi	200 psi	300 psi	500 psi	20 psi	40 psi	80 psi	200 psi	
	1/8	1/4	3/8	1/2	3/4	1/8	1/4	1	1-1/4	2																
65°		•	•	•		•	•				70	.203	2.5	3.5	4.9	7.0	9.9	11.1	15.7	19.2	25	60	65	68	71	
			•	•							100	.243	3.5	5.0	7.1	10.0	14.1	15.8	22	27	35	58	65	69	70	
			•	•								150	.297	5.3	7.5	10.6	15.0	21	24	34	41	53	59	65	68	70
				•	•							200	.343	7.1	10.0	14.1	20	28	32	45	55	71	60	65	67	69
					•							250	.373	8.8	12.5	17.7	25	35	40	56	68	88	60	65	67	69
					•							300	.409	10.6	15.0	21	30	42	47	67	82	106	60	65	67	69
					•							400	.472	14.1	20	28	40	57	63	89	110	141	60	65	67	69
								•	•			500	.528	17.7	25	35	50	71	79	112	137	177	60	65	66	68
							•				580	.569	21	29	41	58	82	92	130	159	205	61	65	66	68	
50°						•					02	.035	.07	.10	.14	.20	.28	.32	.45	.55	.71	39	50	57	63	
						•					03	.043	.11	.15	.21	.30	.42	.47	.67	.82	1.1	40	50	56	62	
						•					04	.050	.14	.20	.28	.40	.57	.63	.89	1.1	1.4	42	50	56	61	
						•					05	.056	.18	.25	.35	.50	.71	.79	1.1	1.4	1.8	44	50	56	61	
						•					055	.059	.19	.28	.39	.55	.78	.87	1.2	1.5	1.9	44	50	56	61	
						•					06	.061	.21	.30	.42	.60	.85	.95	1.3	1.6	2.1	45	50	56	60	
						•					07	.066	.25	.35	.49	.70	.99	1.1	1.6	1.9	2.5	45	50	56	60	
						•					08	.071	.28	.40	.57	.80	1.1	1.3	1.8	2.2	2.8	45	50	55	60	
		•	•	•			•	•				10	.079	.35	.50	.71	1.0	1.4	1.6	2.2	2.7	3.5	45	50	55	59
			•	•	•		•	•				15	.094	.53	.75	1.1	1.5	2.1	2.4	3.4	4.1	5.3	45	50	55	59
		•	•	•	•			•				20	.109	.71	1.0	1.4	2.0	2.8	3.2	4.5	5.5	7.1	45	50	55	59
		•	•	•	•			•				30	.133	1.1	1.5	2.1	3.0	4.2	4.7	6.7	8.2	10.6	45	50	55	59
		•	•	•			•	•				40	.153	1.4	2.0	2.8	4.0	5.7	6.3	8.9	11.0	14.1	46	50	54	59
		•	•	•				•				50	.172	1.8	2.5	3.5	5.0	7.1	7.9	11.2	13.7	17.7	46	50	54	59
			•	•				•				60	.188	2.1	3.0	4.2	6.0	8.5	9.5	13.4	16.4	21	46	50	54	59
			•	•	•			•				70	.203	2.5	3.5	4.9	7.0	9.9	11.1	15.7	19.2	25	46	50	54	59
			•	•								80	.217	2.8	4.0	5.7	8.0	11.3	12.6	17.9	22	28	45	50	53	58
				•								85	.224	3.0	4.3	6.0	8.5	12.0	13.4	19.0	23	30	45	50	53	57
				•								90	.230	3.2	4.5	6.4	9.0	12.7	14.2	20	25	32	45	50	53	56
				•	•							100	.243	3.5	5.0	7.1	10.0	14.1	15.8	22	27	35	44	50	52	54
			•								110	.255	3.9	5.5	7.8	11.0	15.6	17.4	25	30	39	45	50	53	54	
			•								120	.266	4.2	6.0	8.5	12.0	17.0	19.0	27	33	42	44	50	53	55	
			•								135	.282	4.8	6.8	9.5	13.5	19.1	21	30	37	48	45	50	52	55	
			•	•							150	.297	5.3	7.5	10.6	15.0	21	24	34	41	53	45	50	52	55	
				•							200	.343	7.1	10.0	14.1	20	28	32	45	55	71	46	50	52	55	
				•							250	.384	8.8	12.5	17.7	25	35	40	56	68	88	46	50	52	55	
					•						400	.472	14.1	20	28	40	57	63	89	110	141	46	50	52	55	

Highlighted column shows the rated pressure.



**PERFORMANCE DATA
H-U, H-DU AND U VEEJET® NOZZLES**

Spray Angle at 40 psi	Nozzle Type/ Inlet Conn. (in.)										Capacity Size	Equiv. Orifice Dia. (in.)	Flow Rate Capacity (gallons per minute)										Spray Angle (°)			
	H-U					H-DU		U					5 psi	10 psi	20 psi	40 psi	80 psi	100 psi	200 psi	300 psi	500 psi	20 psi	40 psi	80 psi	200 psi	
	1/8	1/4	3/8	1/2	3/4	1/8	1/4	1	1-1/4	2																
50°									●	●		500	.528	17.7	25	35	50	71	79	112	137	177	49	50	51	54
									●			580	.569	21	29	41	58	82	92	130	159	205	49	50	51	53
										●		750	.647	27	38	53	75	106	119	168	205	265	49	50	51	53
											●	1000	.747	35	50	71	100	141	158	224	274	354	49	50	51	53
											●	1500	.915	53	75	106	150	212	237	335	411	530	49	50	51	52
											●	2000	1.056	71	100	141	200	283	316	447	548	707	49	50	51	52
40°	●	●	●				●	●			10	.079	.35	.50	.71	1.0	1.4	1.6	2.2	2.7	3.5	32	40	45	48	
	●	●	●	●			●	●			15	.094	.53	.75	1.1	1.5	2.1	2.4	3.4	4.1	5.3	32	40	45	48	
	●	●	●	●			●	●			20	.109	.71	1.0	1.4	2.0	2.8	3.2	4.5	5.5	7.1	32	40	45	48	
	●	●	●				●	●			30	.133	1.1	1.5	2.1	3.0	4.2	4.7	6.7	8.2	10.6	33	40	45	48	
	●	●	●				●	●			40	.153	1.4	2.0	2.8	4.0	5.7	6.3	8.9	11.0	14.1	34	40	45	48	
		●	●	●				●			50	.172	1.8	2.5	3.5	5.0	7.1	7.9	11.2	13.7	17.7	35	40	45	48	
		●	●	●	●			●			60	.188	2.1	3.0	4.2	6.0	8.5	9.5	13.4	16.4	21	35	40	45	48	
		●	●	●				●			70	.203	2.5	3.5	4.9	7.0	9.9	11.1	15.7	19.2	25	35	40	45	48	
		●									80	.217	2.8	4.0	5.7	8.0	11.3	12.6	17.9	22	28	35	40	44	47	
			●	●							100	.243	3.5	5.0	7.1	10.0	14.1	15.8	22	27	35	34	40	43	46	
			●	●							150	.297	5.3	7.5	10.6	15.0	21	24	34	41	53	35	40	43	44	
				●							200	.343	7.1	10.0	14.1	20	28	32	45	55	71	36	40	42	44	
25°									●		500	.528	17.7	25	35	50	71	79	112	137	177	38	40	41	45	
	●	●					●	●			10	.079	.35	.50	.71	1.0	1.4	1.6	2.2	2.7	3.5	18	25	31	37	
	●	●	●				●	●			15	.094	.53	.75	1.1	1.5	2.1	2.4	3.4	4.1	5.3	18	25	31	37	
	●	●	●				●	●			20	.109	.71	1.0	1.4	2.0	2.8	3.2	4.5	5.5	7.1	19	25	31	37	
	●	●	●				●	●			30	.133	1.1	1.5	2.1	3.0	4.2	4.7	6.7	8.2	10.6	20	25	30	36	
		●	●				●	●			40	.153	1.4	2.0	2.8	4.0	5.7	6.3	8.9	11.0	14.1	21	25	29	35	
		●	●					●			50	.172	1.8	2.5	3.5	5.0	7.1	7.9	11.2	13.7	17.7	21	25	29	35	
		●	●					●			60	.188	2.1	3.0	4.2	6.0	8.5	9.5	13.4	16.4	21	22	25	29	35	
		●	●	●				●			70	.203	2.5	3.5	4.9	7.0	9.9	11.1	15.7	19.2	25	22	25	29	35	
			●	●							100	.243	3.5	5.0	7.1	10.0	14.1	15.8	22	27	35	23	25	28	32	
			●	●							150	.297	5.3	7.5	10.6	15.0	21	24	34	41	53	24	25	28	30	
				●							200	.343	7.1	10.0	14.1	20	28	32	45	55	71	24	25	26	29	
15°									●	●	500	.528	17.7	25	35	50	71	79	112	137	177	24	25	26	29	
									●		750	.647	27	38	53	75	106	119	168	205	265	24	25	26	28	
									●		1000	.747	35	50	71	100	141	158	224	274	354	24	25	26	28	
15°	●	●					●	●			10	.079	.35	.50	.71	1.0	1.4	1.6	2.2	2.7	3.5	10	15	19	24	
	●	●	●				●	●			15	.094	.53	.75	1.1	1.5	2.1	2.4	3.4	4.1	5.3	10	15	19	24	
	●	●	●				●	●			20	.109	.71	1.0	1.4	2.0	2.8	3.2	4.5	5.5	7.1	10	15	19	23	

Highlighted column shows the rated pressure.



PERFORMANCE DATA

ENGLISH UNITS
FLAT SPRAY NOZZLES

ENGLISH UNITS

PERFORMANCE DATA
H-U, H-DU AND U VEEJET® NOZZLES

Spray Angle at 40 psi	Nozzle Type/ Inlet Conn. (in.)										Capacity Size	Equiv. Orifice Dia. (in.)	Flow Rate Capacity (gallons per minute)										Spray Angle (°)			
	H-U					H-DU		U					5 psi	10 psi	20 psi	40 psi	80 psi	100 psi	200 psi	300 psi	500 psi	20 psi	40 psi	80 psi	200 psi	
	1/8	1/4	3/8	1/2	3/4	1/8	1/4	1	1-1/4	2																
15°	•	•	•			•	•				30	.133	1.1	1.5	2.1	3.0	4.2	4.7	6.7	8.2	10.6	10	15	19	21	
	•	•	•			•	•				40	.153	1.4	2.0	2.8	4.0	5.7	6.3	8.9	11.0	14.1	10	15	18	21	
		•	•	•			•					50	.172	1.8	2.5	3.5	5.0	7.1	7.9	11.2	13.7	17.7	11	15	18	21
		•	•				•					60	.188	2.1	3.0	4.2	6.0	8.5	9.5	13.4	16.4	21	11	15	18	21
		•	•	•			•					70	.203	2.5	3.5	4.9	7.0	9.9	11.1	15.7	19.2	25	11	15	18	21
			•	•								100	.243	3.5	5.0	7.1	10.0	14.1	15.8	22	27	35	13	15	17	18
			•									120	.266	4.2	6.0	8.5	12.0	17.0	19.0	27	33	42	13	15	17	18
				•								150	.297	5.3	7.5	10.6	15.0	21	24	34	41	53	14	15	17	18
				•								200	.343	7.1	10.0	14.1	20	28	32	45	55	71	14	15	17	18
								•			500	.528	17.7	25	35	50	71	79	112	137	177	14	15	16	17	
								•			1000	.747	35	50	71	100	141	158	224	274	354	14	15	16	17	
0°	•	•					•				03	.041	.11	.15	.21	.30	.42	.47	.67	.82	1.1	0 Solid Stream				
	•	•					•	•			04	.047	.14	.20	.28	.40	.57	.63	.89	1.1	1.4					
	•	•					•	•			05	.053	.18	.25	.35	.50	.71	.79	1.1	1.4	1.8					
	•	•					•	•			055	.055	.19	.28	.39	.55	.78	.87	1.2	1.5	1.9					
	•	•					•	•			06	.058	.21	.30	.42	.60	.85	.95	1.3	1.6	2.1					
	•	•					•	•			065	.060	.23	.33	.46	.65	.92	1.0	1.5	1.8	2.3					
		•					•	•			07	.062	.25	.35	.49	.70	.99	1.1	1.6	1.9	2.5					
	•	•					•	•			08	.067	.28	.40	.57	.80	1.1	1.3	1.8	2.2	2.8					
	•										085	.069	.30	.43	.60	.85	1.2	1.3	1.9	2.3	3.0					
	•	•					•	•			09	.071	.32	.45	.64	.90	1.3	1.4	2.0	2.5	3.2					
	•	•					•	•			10	.075	.35	.50	.71	1.0	1.4	1.6	2.2	2.7	3.5					
		•						•			12	.082	.42	.60	.85	1.2	1.7	1.9	2.7	3.3	4.2					
	•	•					•	•			15	.091	.53	.75	1.1	1.5	2.1	2.4	3.4	4.1	5.3					
	•	•	•				•	•			20	.106	.71	1.0	1.4	2.0	2.8	3.2	4.5	5.5	7.1					
	•	•					•	•			30	.129	1.1	1.5	2.1	3.0	4.2	4.7	6.7	8.2	10.6					
	•	•					•	•			40	.149	1.4	2.0	2.8	4.0	5.7	6.3	8.9	11.0	14.1					
		•						•			50	.167	1.8	2.5	3.5	5.0	7.1	7.9	11.2	13.7	17.7					
		•							•		60	.183	2.1	3.0	4.2	6.0	8.5	9.5	13.4	16.4	21					
		•	•					•			70	.198	2.5	3.5	4.9	7.0	9.9	11.1	15.7	19.2	25					
		•	•								80	.211	2.8	4.0	5.7	8.0	11.3	12.6	17.9	22	28					
		•								100	.236	3.5	5.0	7.1	10.0	14.1	15.8	22	27	35						
		•								120	.259	4.2	6.0	8.5	12.0	17.0	19.0	27	33	42						
	•		•							150	.289	5.3	7.5	10.6	15.0	21	24	34	41	53						
			•							165	.303	5.8	8.3	11.7	16.5	23	26	37	45	58						
			•							200	.334	7.1	10.0	14.1	20	28	32	45	55	71						

Highlighted column shows the rated pressure.



**PERFORMANCE DATA
H-U, H-DU AND U VEEJET® NOZZLES**

Spray Angle at 40 psi	Nozzle Type/ Inlet Conn. (in.)										Capacity Size	Equiv. Orifice Dia. (in.)	Flow Rate Capacity (gallons per minute)									Spray Angle (°)			
	H-U					H-DU		U					5 psi	10 psi	20 psi	40 psi	80 psi	100 psi	200 psi	300 psi	500 psi	20 psi	40 psi	80 psi	200 psi
	1/8	1/4	3/8	1/2	3/4	1/8	1/4	1	1-1/4	2															
0°			•	•							250	.373	8.8	12.5	17.7	25	35	40	56	68	88	0 Solid Stream			
					•						350	.437	12.4	17.5	25	35	49	55	78	96	124				
								•	•		570	.558	20	29	40	57	81	90	127	156	202				
					•						700	.618	25	35	49	70	99	111	157	192	247				
								•			1000	.739	35	50	71	100	141	158	224	274	354				
								•			1100	.775	39	55	78	110	156	174	246	301	389				
									•		1400	.875	49	70	99	140	198	221	313	383	495				
										•	1800	.992	64	90	127	180	255	285	402	493	636				
										•	2000	1.045	71	100	141	200	283	316	447	548	707				
									•	3500	1.383	124	175	247	350	495	553	783	959	1237					

Highlighted column shows the rated pressure.

DIMENSIONS AND WEIGHTS

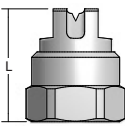
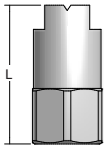
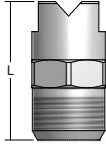
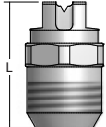
Nozzle	Nozzle Type	Inlet Conn. (in.)	L (in.)	Hex. (in.)	D (Dia.) (in.)	Net Weight (oz.)
	H-DT (F)	1/8	.750	1/2	-	.5
		1/4	.780	5/8	-	.8
	H-DU (F)	1/8	1.125	1/2	-	.8
		1/4	1.250	5/8	-	1.3
	H-U (M)	1/8	1.000	9/16	-	.5
		1/4	1.000	9/16	-	.8
		3/8	1.250	11/16	-	1.5
		1/2	1.500	7/8	-	2.3
		3/4	2.000	1-1/16	-	5
	H-VV (M)	1/8	.875	1/2	-	.5
		1/4	.906	9/16	-	.8

Based on the largest/heaviest version of each type.

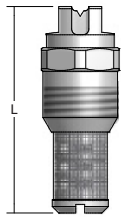
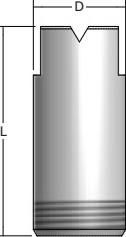
Nozzle	Nozzle Type	Inlet Conn. (in.)	L (in.)	Hex. (in.)	D (Dia.) (in.)	Net Weight (oz.)
	H-VVL (M)	1/8	1.531	1/2	-	.8
		1/4	1.250	9/16	-	1
	U (M)	1	2.313	-	1.313	9
		1-1/4	3.750	-	1.688	20
		2	5.375	-	2.375	68

Based on the largest/heaviest version of each type.

Nozzle	Nozzle Type	Inlet Conn. (in.)	L (in.)	Hex. (in.)
	58600-H3/4U with strainer	3/4	3.84	1-1/16



PERFORMANCE DATA

ENGLISH UNITS
FLAT SPRAY NOZZLES

ENGLISH UNITS

PERFORMANCE DATA
MEG AND MEG-SSTC WASHJET® NOZZLES

Nozzle Type and Spray Angle																				Capacity Size	Flow Rate Capacity (gallons per minute)															
1/8 MEG					1/4 MEG					1/4 MEG-SSTC					40 psi	300 psi	500 psi	750 psi	1000 psi		1500 psi	2000 psi	2500 psi	3000 psi												
0°*	5°	15°	25°	40°	50°	65°	0°*	5°	15°	25°	40°	50°	65°	0°*	5°	15°	25°	40°	50°	65°																
									•					•		•			•			01	.10	.27	.35	.43	.50	.61	.71	.79	.87					
									•													015	.15	.41	.53	.65	.75	.92	1.1	1.2	1.3					
•	•	•	•	•			•	•	•	•	•			•	•	•		•	•			02	.20	.55	.71	.87	1.0	1.2	1.4	1.6	1.7					
														•								025	.25	.68	.88	1.1	1.3	1.5	1.8	2.0	2.2					
•		•	•	•	•		•	•	•	•	•	•	•	•	•		•			•	•	03	.30	.82	1.1	1.3	1.5	1.8	2.1	2.4	2.6					
							•		•	•	•											035	.35	.96	1.2	1.5	1.8	2.1	2.5	2.8	3.0					
•		•	•	•	•	•	•	•	•	•	•	•	•	•	•		•	•		•	•	04	.40	1.1	1.4	1.7	2.0	2.4	2.8	3.2	3.5					
•		•	•	•	•	•	•	•	•	•	•	•	•	•	•		•	•				045	.45	1.2	1.6	1.9	2.3	2.8	3.2	3.6	3.9					
•	•	•	•	•	•	•	•	•	•	•	•	•	•	•	•		•	•	•	•		05	.50	1.4	1.8	2.2	2.5	3.1	3.5	4.0	4.3					
•		•	•	•	•	•	•	•	•	•	•	•	•	•	•		•	•				055	.55	1.5	1.9	2.4	2.8	3.4	3.9	4.3	4.8					
•	•	•	•	•	•	•	•	•	•	•	•	•	•	•	•		•	•	•			06	.60	1.6	2.1	2.6	3.0	3.7	4.2	4.7	5.2					
•		•	•	•	•	•	•	•	•	•	•	•	•	•	•		•					065	.65	1.8	2.3	2.8	3.3	4.0	4.6	5.1	5.6					
•	•	•	•	•	•	•	•	•	•	•	•	•	•	•	•		•	•	•	•		07	.70	1.9	2.5	3.0	3.5	4.3	4.9	5.5	6.1					
•		•	•	•	•	•	•	•	•	•	•	•	•	•	•		•					075	.75	2.1	2.7	3.2	3.8	4.6	5.3	5.9	6.5					
•		•	•	•	•	•	•	•	•	•	•	•	•	•	•		•	•	•		•	08	.80	2.2	2.8	3.5	4.0	4.9	5.7	6.3	6.9					
•		•	•	•	•	•	•	•	•	•	•	•	•	•	•		•					085	.85	2.3	3.0	3.7	4.3	5.2	6.0	6.7	7.4					
•		•	•	•	•	•	•	•	•	•	•	•	•	•	•		•	•	•	•		09	.90	2.5	3.2	3.9	4.5	5.5	6.4	7.1	7.8					
		•	•				•		•													095	.95	2.6	3.4	4.1	4.8	5.8	6.7	7.5	8.2					
•		•	•	•	•	•	•		•	•	•	•	•	•	•		•	•				10	1.0	2.7	3.5	4.3	5.0	6.1	7.1	7.9	8.7					
•			•				•		•	•	•											11	1.1	3.0	3.9	4.8	5.5	6.7	7.8	8.7	9.5					
•		•	•																			115	1.2	3.1	4.1	5.0	5.8	7.0	8.1	9.1	10.0					
•				•			•	•	•	•	•	•	•	•	•		•					12	1.2	3.3	4.2	5.2	6.0	7.3	8.5	9.5	10.4					
•							•		•	•	•	•										125	1.3	3.4	4.4	5.4	6.3	7.7	8.8	9.9	10.8					
•							•		•	•	•											13	1.3	3.6	4.6	5.6	6.5	8.0	9.2	10.3	11.3					
	•								•	•												14	1.4	3.8	4.9	6.1	7.0	8.6	9.9	11.1	12.1					
•		•	•				•	•	•	•	•	•	•	•	•		•		•	•		15	1.5	4.1	5.3	6.5	7.5	9.2	10.6	11.9	13.0					
		•					•		•													16	1.6	4.4	5.7	6.9	8.0	9.8	11.3	12.6	13.9					
							•		•	•	•									•		18	1.8	4.9	6.4	7.8	9.0	11.0	12.7	14.2	15.6					
•							•	•	•	•	•	•	•	•	•		•					20	2.0	5.5	7.1	8.7	10.0	12.2	14.1	15.8	17.3					
							•	•	•	•	•											25	2.5	6.8	8.8	10.8	12.5	15.3	17.7	19.8	22					
							•	•	•	•	•		•									30	3.0	8.2	10.6	13.0	15.0	18.4	21	24	26					
							•		•	•	•											35	3.5	9.6	12.4	15.2	17.5	21	25	28	30					
							•	•	•	•	•											40	4.0	11.0	14.1	17.3	20	24	28	32	35					
							•		•	•	•											50	5.0	13.7	17.7	22	25	31	35	40	43					
							•		•	•	•											60	6.0	16.4	21	26	30	37	42	47	52					
							•															70	7.0	19.2	25	30	35	43	49	55	61					
							•															80	8.0	22	28	35	40	49	57	63	69					
							•															90	9.0	25	32	39	45	55	64	71	78					

*0° = Solid Stream.

Highlighted column shows the rated pressure.

PERFORMANCE DATA
WEG WASHJET® NOZZLES

Nozzle Type and Spray Angle														Capacity Size	Flow Rate Capacity (gallons per minute)									
1/8 WEG							1/4 WEG								40 psi	300 psi	500 psi	750 psi	1000 psi	1500 psi	2000 psi	2500 psi	3000 psi	
0°*	5°	15°	25°	40°	50°	65°	0°*	5°	15°	25°	40°	50°	65°											
		●	●	●											03	.30	.82	1.1	1.3	1.5	1.8	2.1	2.4	2.6
●		●	●	●	●	●	●		●	●	●		●		04	.40	1.1	1.4	1.7	2.0	2.4	2.8	3.2	3.5
		●	●	●					●	●	●				045	.45	1.2	1.6	1.9	2.3	2.8	3.2	3.6	3.9
●		●	●	●	●	●	●		●	●	●	●	●		05	.50	1.4	1.8	2.2	2.5	3.1	3.5	4.0	4.3
●		●	●	●	●	●	●		●	●					055	.55	1.5	1.9	2.4	2.8	3.4	3.9	4.3	4.8
●		●	●	●	●	●	●		●	●	●				06	.60	1.6	2.1	2.6	3.0	3.7	4.2	4.7	5.2
				●					●						065	.65	1.8	2.3	2.8	3.3	4.0	4.6	5.1	5.6
●		●	●	●	●	●	●		●	●	●		●		07	.70	1.9	2.5	3.0	3.5	4.3	4.9	5.5	6.1
●		●	●	●	●	●	●		●	●	●				08	.80	2.2	2.8	3.5	4.0	4.9	5.7	6.3	6.9
●		●	●	●											085	.85	2.3	3.0	3.7	4.3	5.2	6.0	6.7	7.4
●		●	●	●	●	●	●		●	●	●				09	.90	2.5	3.2	3.9	4.5	5.5	6.4	7.1	7.8
			●												095	.95	2.6	3.4	4.1	4.8	5.8	6.7	7.5	8.2
●		●	●	●	●	●	●		●	●	●				10	1.0	2.7	3.5	4.3	5.0	6.1	7.1	7.9	8.7
							●								15	1.5	4.1	5.3	6.5	7.5	9.2	10.6	11.9	13.0
		●													16	1.6	4.4	5.7	6.9	8.0	9.8	11.3	12.6	13.9
●															20	2.0	5.5	7.1	8.7	10.0	12.2	14.1	15.8	17.3
							●								30	3.0	8.2	10.6	13.0	15.0	18.4	21	24	26

*0° = Solid Stream.
Highlighted column shows the rated pressure.

PERFORMANCE DATA
IMEG® WASHJET® NOZZLES

Inlet Conn. (in.)	Nozzle Type	Spray Angle at 40 psi										Capacity Size	Flow Rate Capacity (gallons per minute)										
		IMEG®	5°	10°	15°	25°	40°	50°	65°	80°	40 psi		300 psi	500 psi	750 psi	1000 psi	1500 psi	2000 psi	2500 psi	3000 psi	3500 psi	4000 psi	
1/8, 1/4	●	●	●	●	●	●	●	●	●	●	●	03	.30	.82	1.1	1.3	1.5	1.8	2.1	2.4	2.6	2.8	3.0
	●	●	●	●	●	●	●	●	●	●	●	035	.35	.96	1.2	1.5	1.8	2.1	2.5	2.8	3.0	3.3	3.5
	●	●	●	●	●	●	●	●	●	●	●	04	.40	1.1	1.4	1.7	2.0	2.4	2.8	3.2	3.5	3.7	4.0
	●	●	●	●	●	●	●	●	●	●	●	045	.45	1.2	1.6	1.9	2.3	2.8	3.2	3.6	3.9	4.2	4.5
	●	●	●	●	●	●	●	●	●	●	●	05	.50	1.4	1.8	2.2	2.5	3.1	3.5	4.0	4.3	4.7	5.0
	●	●	●	●	●	●	●	●	●	●	●	055	.55	1.5	1.9	2.4	2.8	3.4	3.9	4.3	4.8	5.1	5.5
	●	●	●	●	●	●	●	●	●	●	●	06	.60	1.6	2.1	2.6	3.0	3.7	4.2	4.7	5.2	5.6	6.0
	●	●	●	●	●	●	●	●	●	●	●	065	.65	1.8	2.3	2.8	3.3	4.0	4.6	5.1	5.6	6.1	6.5
	●	●	●	●	●	●	●	●	●	●	●	07	.70	1.9	2.5	3.0	3.5	4.3	4.9	5.5	6.1	6.5	7.0
	●	●	●	●	●	●	●	●	●	●	●	075	.75	2.1	2.7	3.2	3.8	4.6	5.3	5.9	6.5	7.0	7.5
●	●	●	●	●	●	●	●	●	●	●	08	.80	2.2	2.8	3.5	4.0	4.9	5.7	6.3	6.9	7.5	8.0	

Highlighted column shows the rated pressure.

DIMENSIONS AND WEIGHTS

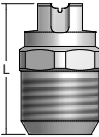
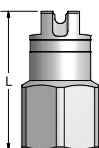
Nozzle	Nozzle Type	Inlet Conn. (in.)	L (in.)	Hex. (in.)	Flats (in.)	Net Weight (oz.)
	MEG (M)	1/8	1.000	9/16	.313	.6
		1/4	1.000	9/16	.406	.8
	WEG (F)	1/8	1.125	1/2	.313	.9
		1/4	1.125	5/8	.313	.7

Based on the largest/heaviest version of each type.

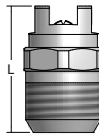
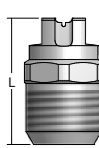
Nozzle	Nozzle Type	Inlet Conn. (in.)	L (in.)	Hex. (in.)	Flats (in.)	Net Weight (oz.)
	MEG-SSTC (M)	1/4	.906	9/16	.406	.6
		1/8	.875	1/2	.313	.6
	IMEG® (M)	1/4	.906	9/16	.406	.8

Based on the largest/heaviest version of each type.

PERFORMANCE DATA
K FLOODJET® NOZZLES

Nozzle Type K	Inlet Conn. (in.)						Capacity Size	Equiv. Orifice Dia. (in.)	Flow Rate Capacity (gallons per minute)							Spray Angle (°)		
	1/8	1/4	3/8	1/2	3/4	1			3 psi	7 psi	10 psi	20 psi	30 psi	40 psi	60 psi	7 psi	20 psi	60 psi
•	•						.25	.017	–	–	–	.04	.04	.05	.06	–	83	117
•	•						.50	.023	–	–	–	.07	.09	.10	.12	–	89	122
•	•						.75	.029	–	–	.075	.11	.13	.15	.18	–	106	125
•	•						1	.033	–	–	.10	.14	.17	.20	.24	–	103	128
•	•						1.5	.040	–	.13	.15	.21	.26	.30	.37	73	103	125
•	•	•					2	.047	–	.17	.20	.28	.35	.40	.49	83	113	129
•	•	•					2.5	.052	–	.21	.25	.35	.43	.50	.61	98	122	133
•	•	•					3	.057	–	.25	.30	.42	.52	.60	.73	86	112	126
•	•						4	.066	–	.33	.40	.57	.69	.80	.98	97	123	132
•	•	•					5	.074	.27	.42	.50	.71	.87	1.0	1.2	114	128	142
•	•	•					7.5	.091	.41	.63	.75	1.1	1.3	1.5	1.8	101	119	134
•	•	•					10	.105	.55	.84	1.0	1.4	1.7	2.0	2.4	115	133	145
•	•	•					12	.115	.66	1.0	1.2	1.7	2.1	2.4	2.9	128	139	153
•	•	•					15	.128	.82	1.3	1.5	2.1	2.6	3.0	3.7	98	113	123
•	•	•					18	.140	.99	1.5	1.8	2.5	3.1	3.6	4.4	106	120	131
•	•	•					20	.148	1.1	1.7	2.0	2.8	3.5	4.0	4.9	110	122	133
•		•					22	.155	1.2	1.8	2.2	3.1	3.8	4.4	5.4	113	125	136
•		•					24	.162	1.3	2.0	2.4	3.4	4.2	4.8	5.9	115	131	144
•		•					27	.172	1.5	2.3	2.7	3.8	4.7	5.4	6.6	119	135	148
•			•				30	.181	1.6	2.5	3.0	4.2	5.2	6.0	7.3	100	110	121
•			•				35	.196	1.9	2.9	3.5	4.9	6.1	7.0	8.6	105	118	128
•			•	•			40	.209	2.2	3.3	4.0	5.7	6.9	8.0	9.8	111	126	136
•			•				45	.222	2.5	3.8	4.5	6.4	7.8	9.0	11.0	115	130	140
•				•			50	.234	2.7	4.2	5.0	7.1	8.7	10.0	12.2	117	131	140
•				•			60	.256	3.3	5.0	6.0	8.5	10.4	12.0	14.7	120	134	142
•				•			70	.277	3.8	5.9	7.0	9.9	12.1	14.0	17.1	123	137	146
•				•			80	.296	4.4	6.7	8.0	11.3	13.9	16.0	19.6	127	138	149
•					•		90	.317	4.9	7.5	9.0	12.7	15.6	18.0	22	120	133	140
•					•		100	.334	5.5	8.4	10.0	14.1	17.3	20	24	123	136	145
•					•		110	.350	6.0	9.2	11.0	15.6	19.1	22	27	125	138	148
•					•		120	.366	6.6	10.0	12.0	17.0	21	24	29	129	143	150
•					•		140	.395	7.7	11.7	14.0	19.8	24	28	34	118	127	135
•					•		160	.423	8.8	13.4	16.0	23	28	32	39	121	130	137
•					•		180	.448	9.9	15.1	18.0	25	31	36	44	124	133	139
•					•		210	.484	11.5	17.6	21	30	36	42	51	128	139	145
•						•	300	.579	16.4	25	30	42	52	60	73	110	128	135
•						•	450	.709	25	38	45	64	78	90	110	118	132	138

Highlighted column shows the rated pressure.



PERFORMANCE DATA
TEK FLOODJET® NOZZLES

Inlet Conn. (in.)	Nozzle Type	Capacity Size	Equiv. Orifice Dia. (in.)	Flow Rate Capacity (gallons per minute)							Spray Angle (°)		
				3 psi	7 psi	10 psi	20 psi	30 psi	40 psi	60 psi	7 psi	20 psi	60 psi
1/8, 1/4	●	2	.047	–	.17	.20	.28	.35	.40	.49	85	125	134
	●	3	.057	–	.25	.30	.42	.52	.60	.73	85	125	136
	●	5	.074	.27	.42	.50	.71	.87	1.0	1.2	85	127	147
	●	10	.105	.55	.84	1.0	1.4	1.7	2.0	2.4	85	130	150
1/4	●	15	.128	.82	1.3	1.5	2.1	2.6	3.0	3.7	90	130	138
	●	20	.148	1.1	1.7	2.0	2.8	3.5	4.0	4.9	107	130	138

DIMENSIONS AND WEIGHTS

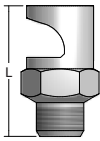
Nozzle	Nozzle Type	Inlet Conn. (in.)	L (in.)	Hex. (in.)	Net Weight (oz.)
	K (M)	1/8	1.281	7/16	.5
		1/4	1.343	9/16	1
		3/8	1.750	11/16	2
		1/2	2.000	7/8	4
		3/4	2.563	1-1/2	14
		1	3.625	1-7/8	32

Based on the largest/heaviest version of each type.

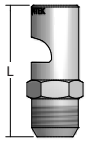
Nozzle	Nozzle Type	Inlet Conn. (in.)	L (in.)	Hex. (in.)	Net Weight (oz.)
	TEK (M)	1/8	1.125	7/16	.6
		1/4	1.520	9/16	1.5

Based on the largest/heaviest version of each type.

PERFORMANCE DATA
P FLATJET® NOZZLES

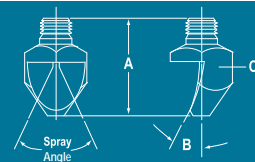

ENGLISH UNITS

Spray Angle at 40 psi	Nozzle Type P	Inlet Conn. (in.)					Capacity Size	Equiv. Orifice Dia. (in.)	Flow Rate Capacity (gallons per minute)							Spray Angle (°)			Dimensions			
		1/8	1/4	3/8	1/2	3/4			15 psi	20 psi	40 psi	80 psi	100 psi	150 psi	15 psi	40 psi	100 psi	A Length (in.)	B Deflection Angle (°)	C Bar Size (in. sq.)	Net Weight (oz.)	
50°	●		●				05	.052	.31	.35	.50	.71	.79	.97	33	50	60	1-7/32	60	5/8	1	
	●		●				10	.074	.61	.71	1.0	1.4	1.6	1.9	34	50	60	1-7/32	60	5/8	1	
	●		●	●			25	.117	1.5	1.8	2.5	3.5	4.0	4.8	42	50	59	1-5/8	42	3/4	3	
	●		●	●			40	.148	2.4	2.8	4.0	5.7	6.3	7.7	39	50	60	1-27/32	45	3/4	3	
	●			●			60	.181	3.7	4.2	6.0	8.5	9.5	11.6	42	50	53	2-5/32	37	1	5	
	●			●			100	.234	6.1	7.1	10.0	14.1	15.8	19.4	43	50	55	2-27/32	40	1-1/4	11.5	
	●			●			125	.261	7.7	8.8	12.5	17.7	19.8	24	38	50	59	2-27/32	38	1-1/4	11	
	●			●			160	.296	9.8	11.3	16.0	23	25	31	44	50	55	2-27/32	37	1-1/4	11	
	●			●			200	.331	12.2	14.1	20	28	32	39	46	50	53	2-27/32	32	1-1/4	11	
40°	●			●			40	.148	2.4	2.8	4.0	5.7	6.3	7.7	31	40	50	2-3/8	35	7/8	5	
	●			●			50	.165	3.1	3.5	5.0	7.1	7.9	9.7	31	40	49	2-1/2	33	1	7	
	●			●			60	.181	3.7	4.2	6.0	8.5	9.5	11.6	32	40	49	2-27/32	33	1	8	
	●			●			70	.196	4.3	4.9	7.0	9.9	11.1	13.6	32	40	49	2-31/32	29	1	9	
	●			●			80	.209	4.9	5.7	8.0	11.3	12.6	15.5	32	40	48	3-1/32	26	1	9	
	●			●			90	.222	5.5	6.4	9.0	12.7	14.2	17.4	34	40	44	3-1/32	28	1	8	
	●			●			100	.234	6.1	7.1	10.0	14.1	15.8	19.4	35	40	44	3-13/32	28	1	9	
35°	●	●					04	.047	.24	.28	.40	.57	.63	.77	20	35	41	29/32	40	7/16	.5	
	●		●				10	.074	.61	.71	1.0	1.4	1.6	1.9	18	35	39	1-7/16	36	5/8	2	
	●		●	●			20	.105	1.2	1.4	2.0	2.8	3.2	3.9	24	35	40	1-21/32	30	3/4	2	
	●			●			25	.117	1.5	1.8	2.5	3.5	4.0	4.8	24	35	39	1-15/16	28	3/4	3	
	●			●			30	.128	1.8	2.1	3.0	4.2	4.7	5.8	26	35	41	2-1/16	28	3/4	3	
	●			●			40	.148	2.4	2.8	4.0	5.7	6.3	7.7	28	35	38	2-9/32	26	7/8	4	
	●			●			50	.165	3.1	3.5	5.0	7.1	7.9	9.7	31	35	38	2-1/2	23	7/8	5	
	●				●		60	.181	3.7	4.2	6.0	8.5	9.5	11.6	29	35	39	2-7/8	27	1	8	
	●				●		80	.209	4.9	5.7	8.0	11.3	12.6	15.5	26	35	40	3-3/16	24	1	9	
	●				●		100	.234	6.1	7.1	10.0	14.1	15.8	19.4	26	35	40	3-1/2	19	1	9	
	●					●	160	.296	9.8	11.3	16.0	23	25	31	26	35	40	4-1/2	23	1-1/4	20	
	●					●	200	.331	12.2	14.1	20	28	32	39	25	35	40	4-13/16	22	1-1/4	20	
25°	●		●				40	.148	2.4	2.8	4.0	5.7	6.3	7.7	15	25	34	2-9/16	25	3/4	4	
15°	●		●				10	.074	-	.71	1.0	1.4	1.6	1.9	-	15	23	1-7/8	22	5/8	2	
	●		●				20	.105	-	1.4	2.0	2.8	3.2	3.9	-	15	19	2-1/8	19	5/8	2	
	●			●			30	.128	1.8	2.1	3.0	4.2	4.7	5.8	6	15	24	2-27/32	25	3/4	4	
	●			●			40	.148	2.4	2.8	4.0	5.7	6.3	7.7	8	15	21	3-5/8	18	7/8	8	
	●			●			50	.165	3.1	3.5	5.0	7.1	7.9	9.7	9	15	20	3-9/16	15	7/8	6	
	●				●		60	.181	3.7	4.2	6.0	8.5	9.5	11.6	10	15	19	4-15/16	14	1	12	
	●				●		80	.209	4.9	5.7	8.0	11.3	12.6	15.5	11	15	18	5-1/8	14	1	12	
	●				●		100	.234	6.1	7.1	10.0	14.1	15.8	19.4	11	15	18	5-5/32	14	1	14	
	●					●	200	.331	12.2	14.1	20	28	32	39	12	15	18	6-1/2	14	1-1/4	26	

Highlighted column shows the rated pressure.



PERFORMANCE DATA

ENGLISH UNITS
FLAT SPRAY NOZZLES

ENGLISH UNITS

PERFORMANCE DATA
TPU AND 13802 UNIJET® SPRAY TIPS

Spray Angle at 40 psi	Tip Type	Capacity Size	Equiv. Orifice Dia. (in.)	Flow Rate Capacity (gallons per minute)										Spray Angle (°)			
	TPU, 13802			5 psi	10 psi	20 psi	40 psi	80 psi	100 psi	200 psi	300 psi	500 psi	20 psi	40 psi	80 psi	200 psi	
110°	●	0033	.015	—	—	.023	.033	.047	.052	.07	.09	.12	91	110	116	121	
	●	0050	.018	—	—	.035	.050	.07	.08	.11	.14	.18	91	110	118	124	
	●	0067	.021	—	—	.05	.067	.09	.11	.15	.18	.24	92	110	118	124	
	●	01	.026	.035	.05	.07	.10	.14	.16	.22	.27	.35	94	110	121	124	
	●	015	.032	.05	.08	.11	.15	.21	.24	.34	.41	.53	97	110	121	124	
	●	02	.035	.07	.10	.14	.20	.28	.32	.45	.55	.71	98	110	120	123	
	●	03	.043	.11	.15	.21	.30	.42	.47	.67	.82	1.1	99	110	120	123	
	●	04	.050	.14	.20	.28	.40	.57	.63	.89	1.1	1.4	100	110	119	122	
	●	05	.056	.18	.25	.35	.50	.71	.79	1.1	1.4	1.8	100	110	118	122	
	●	06	.061	.21	.30	.42	.60	.85	.95	1.3	1.6	2.1	101	110	117	122	
	●	07	.066	.25	.35	.49	.70	.99	1.1	1.6	1.9	2.5	102	110	117	121	
	●	08	.071	.28	.40	.57	.80	1.1	1.3	1.8	2.2	2.8	102	110	117	121	
	●	10	.079	.35	.50	.71	1.0	1.4	1.6	2.2	2.7	3.5	103	110	117	119	
	●	12	.087	.42	.60	.85	1.2	1.7	1.9	2.7	3.3	4.2	103	110	117	119	
	●	15	.097	.53	.75	1.1	1.5	2.1	2.4	3.4	4.1	5.3	104	110	117	118	
●	20	.112	.71	1.0	1.4	2.0	2.8	3.2	4.5	5.5	7.1	105	110	117	118		
●	30	.133	1.1	1.5	2.1	3.0	4.2	4.7	6.7	8.2	10.6	105	110	117	118		
95°	●	01	.026	.035	.05	.07	.10	.14	.16	.22	.27	.35	81	95	105	113	
	●	015	.032	.05	.08	.11	.15	.21	.24	.34	.41	.53	82	95	105	113	
	●	02	.035	.07	.10	.14	.20	.28	.32	.45	.55	.71	82	95	105	113	
	●	03	.043	.11	.15	.21	.30	.42	.47	.67	.82	1.1	83	95	104	111	
	●	04	.050	.14	.20	.28	.40	.57	.63	.89	1.1	1.4	84	95	103	108	
	●	05	.056	.18	.25	.35	.50	.71	.79	1.1	1.4	1.8	84	95	102	107	
	●	06	.061	.21	.30	.42	.60	.85	.95	1.3	1.6	2.1	86	95	101	106	
	●	07	.066	.25	.35	.49	.70	.99	1.1	1.6	1.9	2.5	86	95	101	106	
	●	08	.071	.28	.40	.57	.80	1.1	1.3	1.8	2.2	2.8	87	95	100	105	
	●	09	.075	.32	.45	.64	.90	1.3	1.4	2.0	2.5	3.2	89	95	100	105	
	●	10	.079	.35	.50	.71	1.0	1.4	1.6	2.2	2.7	3.5	89	95	100	105	
	●	11	.083	.39	.55	.78	1.1	1.6	1.7	2.5	3.0	3.9	89	95	100	105	
	●	12	.087	.42	.60	.85	1.2	1.7	1.9	2.7	3.3	4.2	89	95	100	105	
	●	13	.090	.46	.65	.92	1.3	1.8	2.1	2.9	3.6	4.6	89	95	100	105	
	●	14	.093	.49	.70	.99	1.4	2.0	2.2	3.1	3.8	4.9	89	95	100	105	
	●	15	.097	.53	.75	1.1	1.5	2.1	2.4	3.4	4.1	5.3	90	95	100	105	
	●	16	.100	.57	.80	1.1	1.6	2.3	2.5	3.6	4.4	5.7	90	95	100	105	
	●	18	.106	.64	.90	1.3	1.8	2.5	2.8	4.0	4.9	6.4	90	95	100	105	
	●	20	.112	.71	1.0	1.4	2.0	2.8	3.2	4.5	5.5	7.1	90	95	100	105	
	●	30	.133	1.1	1.5	2.1	3.0	4.2	4.7	6.7	8.2	10.6	91	95	101	105	
●	40	.153	1.4	2.0	2.8	4.0	5.7	6.3	8.9	11.0	14.1	92	95	100	105		
●	50	.172	1.8	2.5	3.5	5.0	7.1	7.9	11.2	13.7	17.7	93	95	99	103		
●	60	.188	2.1	3.0	4.2	6.0	8.5	9.5	13.4	16.4	21	93	95	99	103		
●	70	.203	2.5	3.5	4.9	7.0	9.9	11.1	15.7	19.2	25	93	95	99	103		
80°	●	0050	.018	—	—	.035	.050	.07	.08	.11	.14	.18	61	80	95	101	
	●	0067	.021	—	.033	.05	.067	.09	.11	.15	.18	.24	67	80	94	99	
	●	01	.026	—	.05	.07	.10	.14	.16	.22	.27	.35	68	80	89	92	
	●	015	.032	—	.08	.11	.15	.21	.24	.34	.41	.53	68	80	89	92	
	●	02	.035	.07	.10	.14	.20	.28	.32	.45	.55	.71	69	80	88	91	
	●	03	.043	.11	.15	.21	.30	.42	.47	.67	.82	1.1	70	80	87	90	
	●	04	.050	.14	.20	.28	.40	.57	.63	.89	1.1	1.4	71	80	86	89	
	●	045	.053	.16	.23	.32	.45	.64	.71	1.0	1.2	1.6	71	80	86	89	
●	05	.056	.18	.25	.35	.50	.71	.79	1.1	1.4	1.8	71	80	86	89		
●	06	.061	.21	.30	.42	.60	.85	.95	1.3	1.6	2.1	72	80	85	88		

Other body types may be available. Contact your sales engineer for further information.



**PERFORMANCE DATA
TPU AND 13802 UNIJET® SPRAY TIPS**

Spray Angle at 40 psi	Tip Type	Capacity Size	Equiv. Orifice Dia. (in.)	Flow Rate Capacity (gallons per minute)									Spray Angle (°)			
	TPU, 13802			5 psi	10 psi	20 psi	40 psi	80 psi	100 psi	200 psi	300 psi	500 psi	20 psi	40 psi	80 psi	200 psi
80°	●	07	.066	.25	.35	.49	.70	.99	1.1	1.6	1.9	2.5	72	80	85	88
	●	08	.071	.28	.40	.57	.80	1.1	1.3	1.8	2.2	2.8	72	80	84	87
	●	09	.075	.32	.45	.64	.90	1.3	1.4	2.0	2.5	3.2	73	80	84	87
	●	10	.079	.35	.50	.71	1.0	1.4	1.6	2.2	2.7	3.5	73	80	84	87
	●	11	.083	.39	.55	.78	1.1	1.6	1.7	2.5	3.0	3.9	73	80	83	86
	●	12	.087	.42	.60	.85	1.2	1.7	1.9	2.7	3.3	4.2	73	80	83	86
	●	13	.090	.46	.65	.92	1.3	1.8	2.1	2.9	3.6	4.6	73	80	83	86
	●	14	.093	.49	.70	.99	1.4	2.0	2.2	3.1	3.8	4.9	73	80	83	86
	●	15	.097	.53	.75	1.1	1.5	2.1	2.4	3.4	4.1	5.3	74	80	83	86
	●	16	.100	.57	.80	1.1	1.6	2.3	2.5	3.6	4.4	5.7	74	80	83	86
	●	17	.103	.60	.85	1.2	1.7	2.4	2.7	3.8	4.7	6.0	74	80	83	86
	●	20	.112	.71	1.0	1.4	2.0	2.8	3.2	4.5	5.5	7.1	74	80	83	86
	●	25	.121	.88	1.3	1.8	2.5	3.5	4.0	5.6	6.8	8.8	74	80	83	86
	●	30	.133	1.1	1.5	2.1	3.0	4.2	4.7	6.7	8.2	10.6	74	80	83	86
	●	40	.153	1.4	2.0	2.8	4.0	5.7	6.3	8.9	11.0	14.1	74	80	83	86
	●	50	.172	1.8	2.5	3.5	5.0	7.1	7.9	11.2	13.7	17.7	74	80	83	85
	●	60	.188	2.1	3.0	4.2	6.0	8.5	9.5	13.4	16.4	21	75	80	83	85
●	70	.203	2.5	3.5	4.9	7.0	9.9	11.1	15.7	19.2	25	75	80	83	86	
73°	●	0023	.012	–	–	.016	.023	.032	.036	.051	.063	.081	50	73	89	97
	●	0039	.016	–	.020	.028	.039	.055	.062	.087	.11	.14	53	73	87	93
	●	0077	.023	–	.039	.055	.077	.11	.12	.17	.21	.27	53	73	86	92
	●	0116	.028	.041	.058	.082	.12	.16	.18	.26	.32	.41	54	73	85	90
	●	0154	.032	.054	.077	.11	.15	.22	.24	.34	.42	.54	55	73	84	88
	●	0231	.038	.082	.12	.16	.23	.33	.37	.52	.63	.82	56	73	83	87
	●	0308	.044	.11	.15	.22	.31	.44	.49	.69	.84	1.1	58	73	82	86
	●	0385	.049	.14	.19	.27	.39	.54	.61	.86	1.1	1.4	59	73	81	85
	●	0462	.054	.16	.23	.33	.46	.65	.73	1.0	1.3	1.6	60	73	80	84
	●	0616	.062	.22	.31	.44	.62	.87	.97	1.4	1.7	2.2	63	73	79	83
	●	0770	.069	.27	.39	.54	.77	1.1	1.2	1.7	2.1	2.7	64	73	77	82
	●	0924	.076	.33	.46	.65	.92	1.3	1.5	2.1	2.5	3.3	65	73	77	80
65°	●	0017	.011	–	–	.012	.017	.024	.027	.038	.047	.06	44	65	77	86
	●	0025	.013	–	–	.018	.025	.035	.040	.06	.07	.09	45	65	77	84
	●	0033	.015	–	–	.023	.033	.047	.052	.07	.09	.12	47	65	76	83
	●	0050	.018	–	–	.035	.050	.07	.08	.11	.14	.18	48	65	75	82
	●	0067	.021	–	.033	.05	.067	.09	.11	.15	.18	.24	50	65	75	81
	●	01	.026	–	.05	.07	.10	.14	.16	.22	.27	.35	51	65	74	80
	●	015	.032	–	.08	.11	.15	.21	.24	.34	.41	.53	51	65	74	80
	●	02	.035	.07	.10	.14	.20	.28	.32	.45	.55	.71	52	65	73	79
	●	025	.039	.09	.13	.18	.25	.35	.40	.56	.68	.88	52	65	73	79
	●	03	.043	.11	.15	.21	.30	.42	.47	.67	.82	1.1	53	65	72	78
	●	035	.047	.12	.18	.25	.35	.49	.55	.78	.96	1.2	53	65	72	78
	●	04	.050	.14	.20	.28	.40	.57	.63	.89	1.1	1.4	53	65	72	76

Other body types may be available. Contact your sales engineer for further information.
Highlighted column shows the rated pressure.



PERFORMANCE DATA

ENGLISH UNITS
FLAT SPRAY NOZZLES

ENGLISH UNITS

PERFORMANCE DATA
TPU AND 13802 UNIJET® SPRAY TIPS

Spray Angle at 40 psi	Tip Type	Capacity Size	Equiv. Orifice Dia. (in.)	Flow Rate Capacity (gallons per minute)									Spray Angle (°)			
	TPU, 13802			5 psi	10 psi	20 psi	40 psi	80 psi	100 psi	200 psi	300 psi	500 psi	20 psi	40 psi	80 psi	200 psi
65°	●	05	.056	.18	.25	.35	.50	.71	.79	1.1	1.4	1.8	53	65	72	76
	●	055	.059	.19	.28	.39	.55	.78	.87	1.2	1.5	1.9	53	65	72	76
	●	06	.061	.21	.30	.42	.60	.85	.95	1.3	1.6	2.1	54	65	72	75
	●	07	.066	.25	.35	.49	.70	.99	1.1	1.6	1.9	2.5	54	65	72	75
	●	08	.071	.28	.40	.57	.80	1.1	1.3	1.8	2.2	2.8	55	65	71	74
	●	09	.075	.32	.45	.64	.90	1.3	1.4	2.0	2.5	3.2	55	65	71	74
	●	10	.079	.35	.50	.71	1.0	1.4	1.6	2.2	2.7	3.5	56	65	71	74
	●	11	.083	.39	.55	.78	1.1	1.6	1.7	2.5	3.0	3.9	56	65	71	74
	●	12	.087	.42	.60	.85	1.2	1.7	1.9	2.7	3.3	4.2	56	65	71	74
	●	13	.090	.46	.65	.92	1.3	1.8	2.1	2.9	3.6	4.6	56	65	71	74
	●	14	.093	.49	.70	.99	1.4	2.0	2.2	3.1	3.8	4.9	56	65	71	74
	●	15	.097	.53	.75	1.1	1.5	2.1	2.4	3.4	4.1	5.3	56	65	70	73
	●	20	.112	.71	1.0	1.4	2.0	2.8	3.2	4.5	5.5	7.1	57	65	70	73
	●	30	.133	1.1	1.5	2.1	3.0	4.2	4.7	6.7	8.2	10.6	58	65	69	72
	●	40	.153	1.4	2.0	2.8	4.0	5.7	6.3	8.9	11.0	14.1	59	65	68	72
	●	50	.172	1.8	2.5	3.5	5.0	7.1	7.9	11.2	13.7	17.7	60	65	68	71
	●	60	.188	2.1	3.0	4.2	6.0	8.5	9.5	13.4	16.4	21	60	65	68	71
	●	70	.203	2.5	3.5	4.9	7.0	9.9	11.1	15.7	19.2	25	60	65	68	71
50°	●	0017	.011	–	–	.012	.017	.024	.027	.038	.047	.06	27	50	65	74
	●	0025	.013	–	–	.018	.025	.035	.040	.06	.07	.09	29	50	64	71
	●	0033	.015	–	–	.023	.033	.047	.052	.07	.09	.12	30	50	62	68
	●	0050	.018	–	–	.035	.050	.07	.08	.11	.14	.18	32	50	60	66
	●	0067	.021	–	–	.05	.067	.09	.11	.15	.18	.24	35	50	60	66
	●	01	.026	–	.05	.07	.10	.14	.16	.22	.27	.35	37	50	59	65
	●	015	.032	–	.08	.11	.15	.21	.24	.34	.41	.53	38	50	58	64
	●	02	.035	–	.10	.14	.20	.28	.32	.45	.55	.71	39	50	57	63
	●	025	.039	.09	.13	.18	.25	.35	.40	.56	.68	.88	40	50	57	63
	●	03	.043	.11	.15	.21	.30	.42	.47	.67	.82	1.1	40	50	56	62
	●	035	.047	.12	.18	.25	.35	.49	.55	.78	.96	1.2	40	50	56	61
	●	04	.050	.14	.20	.28	.40	.57	.63	.89	1.1	1.4	42	50	56	61
	●	05	.056	.18	.25	.35	.50	.71	.79	1.1	1.4	1.8	44	50	56	61
	●	06	.061	.21	.30	.42	.60	.85	.95	1.3	1.6	2.1	45	50	56	60
	●	07	.066	.25	.35	.49	.70	.99	1.1	1.6	1.9	2.5	45	50	56	60
	●	075	.068	.27	.38	.53	.75	1.1	1.2	1.7	2.1	2.7	45	50	55	60
	●	08	.071	.28	.40	.57	.80	1.1	1.3	1.8	2.2	2.8	45	50	55	60
	●	09	.075	.32	.45	.64	.90	1.3	1.4	2.0	2.5	3.2	45	50	55	59
	●	10	.079	.35	.50	.71	1.0	1.4	1.6	2.2	2.7	3.5	45	50	55	59
	●	13	.090	.46	.65	.92	1.3	1.8	2.1	2.9	3.6	4.6	45	50	55	59
●	15	.097	.53	.75	1.1	1.5	2.1	2.4	3.4	4.1	5.3	45	50	55	59	
●	20	.112	.71	1.0	1.4	2.0	2.8	3.2	4.5	5.5	7.1	45	50	55	59	
●	30	.133	1.1	1.5	2.1	3.0	4.2	4.7	6.7	8.2	10.6	45	50	55	59	
●	40	.153	1.4	2.0	2.8	4.0	5.7	6.3	8.9	11.0	14.1	46	50	54	59	

Other body types may be available. Contact your sales engineer for further information.
Highlighted column shows the rated pressure.



PERFORMANCE DATA:
TPU AND 13802 UNIJET® SPRAY TIPS

Spray Angle at 40 psi	Tip Type	Capacity Size	Equiv. Orifice Dia. (in.)	Flow Rate Capacity (gallons per minute)									Spray Angle (°)			
	TPU, 13802			5 psi	10 psi	20 psi	40 psi	80 psi	100 psi	200 psi	300 psi	500 psi	20 psi	40 psi	80 psi	200 psi
50°	●	50	.172	1.8	2.5	3.5	5.0	7.1	7.9	11.2	13.7	17.7	46	50	54	59
	●	60	.188	2.1	3.0	4.2	6.0	8.5	9.5	13.4	16.4	21	46	50	54	59
	●	70	.203	2.5	3.5	4.9	7.0	9.9	11.1	15.7	19.2	25	46	50	54	59
40°	●	0017	.011	–	–	.012	.017	.024	.027	.038	.047	.06	21	40	54	61
	●	0025	.013	–	–	.018	.025	.035	.040	.06	.07	.09	22	40	53	60
	●	0033	.015	–	–	.023	.033	.047	.052	.07	.09	.12	22	40	53	60
	●	0050	.018	–	–	.035	.050	.07	.08	.11	.14	.18	22	40	53	60
	●	0067	.021	–	–	.05	.067	.09	.11	.15	.18	.24	24	40	53	60
	●	01	.026	–	–	.07	.10	.14	.16	.22	.27	.35	26	40	52	59
	●	015	.032	–	–	.11	.15	.21	.24	.34	.41	.53	27	40	52	59
	●	02	.035	–	.10	.14	.20	.28	.32	.45	.55	.71	29	40	51	58
	●	025	.039	–	.13	.18	.25	.35	.40	.56	.68	.88	29	40	51	58
	●	03	.043	–	.15	.21	.30	.42	.47	.67	.82	1.1	30	40	50	57
	●	04	.050	–	.20	.28	.40	.57	.63	.89	1.1	1.4	30	40	50	56
	●	05	.056	–	.25	.35	.50	.71	.79	1.1	1.4	1.8	31	40	49	55
	●	055	.059	–	.28	.39	.55	.78	.87	1.2	1.5	1.9	31	40	49	55
	●	06	.061	–	.30	.42	.60	.85	.95	1.3	1.6	2.1	31	40	49	55
	●	07	.066	.25	.35	.49	.70	.99	1.1	1.6	1.9	2.5	31	40	49	55
	●	08	.071	.28	.40	.57	.80	1.1	1.3	1.8	2.2	2.8	31	40	47	53
	●	09	.075	.32	.45	.64	.90	1.3	1.4	2.0	2.5	3.2	32	40	45	48
	●	10	.079	.35	.50	.71	1.0	1.4	1.6	2.2	2.7	3.5	32	40	45	48
	●	11	.083	.39	.55	.78	1.1	1.6	1.7	2.5	3.0	3.9	32	40	45	48
	●	12	.087	.42	.60	.85	1.2	1.7	1.9	2.7	3.3	4.2	32	40	45	48
	●	13	.090	.46	.65	.92	1.3	1.8	2.1	2.9	3.6	4.6	32	40	45	48
	●	15	.097	.53	.75	1.1	1.5	2.1	2.4	3.4	4.1	5.3	32	40	45	48
	●	20	.112	.71	1.0	1.4	2.0	2.8	3.2	4.5	5.5	7.1	32	40	45	48
	●	25	.121	.88	1.3	1.8	2.5	3.5	4.0	5.6	6.8	8.8	32	40	45	48
	●	30	.133	1.1	1.5	2.1	3.0	4.2	4.7	6.7	8.2	10.6	33	40	45	48
	●	40	.153	1.4	2.0	2.8	4.0	5.7	6.3	8.9	11.0	14.1	34	40	45	48
	●	50	.172	1.8	2.5	3.5	5.0	7.1	7.9	11.2	13.7	17.7	35	40	45	48
	●	60	.188	2.1	3.0	4.2	6.0	8.5	9.5	13.4	16.4	21	35	40	45	48
●	70	.203	2.5	3.5	4.9	7.0	9.9	11.1	15.7	19.2	25	35	40	45	48	
25°	●	0017	.011	–	–	–	.017	.024	.027	.038	.047	.06	–	25	35	47
	●	0025	.013	–	–	–	.025	.035	.040	.06	.07	.09	–	25	35	45
	●	0033	.015	–	–	–	.033	.047	.052	.07	.09	.12	–	25	34	44
	●	0050	.018	–	–	–	.050	.07	.08	.11	.14	.18	–	25	34	43
	●	0067	.021	–	–	–	.067	.09	.11	.15	.18	.24	–	25	34	42
	●	01	.026	–	–	.07	.10	.14	.16	.22	.27	.35	14	25	34	42
	●	015	.032	–	–	.11	.15	.21	.24	.34	.41	.53	15	25	34	41
	●	02	.035	–	–	.14	.20	.28	.32	.45	.55	.71	15	25	33	40
●	03	.043	–	–	.21	.30	.42	.47	.67	.82	1.1	15	25	33	40	
●	04	.050	–	.20	.28	.40	.57	.63	.89	1.1	1.4	16	25	32	39	

Other body types may be available. Contact your sales engineer for further information.
Highlighted column shows the rated pressure.



PERFORMANCE DATA

ENGLISH UNITS
FLAT SPRAY NOZZLES

ENGLISH UNITS

PERFORMANCE DATA:
TPU AND 13802 UNIJET® SPRAY TIPS

Spray Angle at 40 psi	Tip Type	Capacity Size	Equiv. Orifice Dia. (in.)	Flow Rate Capacity (gallons per minute)									Spray Angle (°)			
	TPU, 13802			5 psi	10 psi	20 psi	40 psi	80 psi	100 psi	200 psi	300 psi	500 psi	20 psi	40 psi	80 psi	200 psi
25°	●	05	.056	–	.25	.35	.50	.71	.79	1.1	1.4	1.8	16	25	32	39
	●	055	.059	–	.28	.39	.55	.78	.87	1.2	1.5	1.9	16	25	32	39
	●	06	.061	–	.30	.42	.60	.85	.95	1.3	1.6	2.1	17	25	31	38
	●	07	.066	–	.35	.49	.70	.99	1.1	1.6	1.9	2.5	17	25	31	38
	●	08	.071	–	.40	.57	.80	1.1	1.3	1.8	2.2	2.8	17	25	31	38
	●	09	.075	–	.45	.64	.90	1.3	1.4	2.0	2.5	3.2	17	25	31	38
	●	10	.079	–	.50	.71	1.0	1.4	1.6	2.2	2.7	3.5	18	25	31	37
	●	13	.090	–	.65	.92	1.3	1.8	2.1	2.9	3.6	4.6	18	25	31	37
	●	15	.097	–	.75	1.1	1.5	2.1	2.4	3.4	4.1	5.3	18	25	31	37
	●	20	.112	–	1.0	1.4	2.0	2.8	3.2	4.5	5.5	7.1	19	25	31	37
	●	30	.133	1.1	1.5	2.1	3.0	4.2	4.7	6.7	8.2	10.6	20	25	30	36
	●	40	.153	1.4	2.0	2.8	4.0	5.7	6.3	8.9	11.0	14.1	21	25	29	35
	●	50	.172	1.8	2.5	3.5	5.0	7.1	7.9	11.2	13.7	17.7	21	25	29	35
	●	60	.188	2.1	3.0	4.2	6.0	8.5	9.5	13.4	16.4	21	22	25	29	35
15°	●	0017	.011	–	–	–	.017	.024	.027	.038	.047	.06	–	15	30	37
	●	0025	.013	–	–	–	.025	.035	.040	.06	.07	.09	–	15	28	34
	●	0033	.015	–	–	–	.033	.047	.052	.07	.09	.12	–	15	27	32
	●	0050	.018	–	–	–	.050	.07	.08	.11	.14	.18	–	15	26	30
	●	0067	.021	–	–	–	.067	.09	.11	.15	.18	.24	–	15	25	29
	●	01	.026	–	–	–	.10	.14	.16	.22	.27	.35	–	15	24	28
	●	015	.032	–	–	–	.15	.21	.24	.34	.41	.53	–	15	23	27
	●	02	.035	–	–	.14	.20	.28	.32	.45	.55	.71	6	15	22	27
	●	03	.043	–	–	.21	.30	.42	.47	.67	.82	1.1	6	15	22	27
	●	04	.050	–	–	.28	.40	.57	.63	.89	1.1	1.4	7	15	21	26
	●	05	.056	–	–	.35	.50	.71	.79	1.1	1.4	1.8	7	15	21	26
	●	055	.059	–	–	.39	.55	.78	.87	1.2	1.5	1.9	7	15	21	26
	●	06	.061	–	–	.42	.60	.85	.95	1.3	1.6	2.1	8	15	21	26
	●	07	.066	–	–	.49	.70	.99	1.1	1.6	1.9	2.5	8	15	21	26
	●	08	.071	–	–	.57	.80	1.1	1.3	1.8	2.2	2.8	9	15	20	25
	●	09	.075	–	–	.64	.90	1.3	1.4	2.0	2.5	3.2	9	15	20	25
	●	10	.079	–	–	.71	1.0	1.4	1.6	2.2	2.7	3.5	10	15	19	24
	●	11	.083	–	.55	.78	1.1	1.6	1.7	2.5	3.0	3.9	10	15	19	24
	●	12	.087	.42	.60	.85	1.2	1.7	1.9	2.7	3.3	4.2	10	15	19	24
	●	15	.097	.53	.75	1.1	1.5	2.1	2.4	3.4	4.1	5.3	10	15	19	24
	●	20	.112	.71	1.0	1.4	2.0	2.8	3.2	4.5	5.5	7.1	10	15	19	23
	●	30	.133	1.1	1.5	2.1	3.0	4.2	4.7	6.7	8.2	10.6	10	15	19	21
	●	40	.153	1.4	2.0	2.8	4.0	5.7	6.3	8.9	11.0	14.1	10	15	18	21
	●	50	.172	1.8	2.5	3.5	5.0	7.1	7.9	11.2	13.7	17.7	11	15	18	21
	●	60	.188	2.1	3.0	4.2	6.0	8.5	9.5	13.4	16.4	21	11	15	18	21
	●	70	.203	2.5	3.5	4.9	7.0	9.9	11.1	15.7	19.2	25	11	15	18	21

Other body types may be available. Contact your sales engineer for further information.
Highlighted column shows the rated pressure.



PERFORMANCE DATA:
TPU AND 13802 UNIJET® SPRAY TIPS

Spray Angle at 40 psi	Tip Type	Capacity Size	Equiv. Orifice Dia. (in.)	Flow Rate Capacity (gallons per minute)									Spray Angle (°)			
	TPU, 13802			5 psi	10 psi	20 psi	40 psi	80 psi	100 psi	200 psi	300 psi	500 psi	20 psi	40 psi	80 psi	200 psi
0°	●	0009	.008	.003	.003	.005	.009	.013	.014	.020	.025	.032	0 Solid Stream			
	●	0012	.010	.004	.006	.008	.012	.017	.019	.027	.033	.042				
	●	0019	.012	.007	.009	.013	.019	.027	.030	.043	.052	.067				
	●	0021	.013	.007	.010	.011	.023	.033	.040	.047	.052	.074				
	●	0033	.016	.01	.02	.023	.033	.047	.052	.07	.09	.12				
	●	0050	.019	.018	.025	.035	.050	.07	.08	.11	.14	.18				
	●	0067	.023	.024	.033	.05	.067	.09	.11	.15	.18	.24				
	●	01	.028	.035	.05	.07	.10	.14	.16	.22	.27	.35				
	●	015	.034	.05	.08	.11	.15	.21	.24	.34	.41	.53				
	●	02	.039	.07	.10	.14	.20	.28	.32	.45	.55	.71				
	●	03	.041	.11	.15	.21	.30	.42	.47	.67	.82	1.1				
	●	04	.047	.14	.20	.28	.40	.57	.63	.89	1.1	1.4				
	●	045	.052	.16	.23	.32	.45	.64	.71	1.0	1.2	1.6				
	●	05	.053	.18	.25	.35	.50	.71	.79	1.1	1.4	1.8				
	●	055	.055	.19	.28	.39	.55	.78	.87	1.2	1.5	1.9				
	●	06	.058	.21	.30	.42	.60	.85	.95	1.3	1.6	2.1				
	●	065	.060	.23	.33	.46	.65	.92	1.0	1.5	1.8	2.3				
	●	07	.062	.25	.35	.49	.70	.99	1.1	1.6	1.9	2.5				
	●	08	.067	.28	.40	.57	.80	1.1	1.3	1.8	2.2	2.8				
	●	09	.071	.32	.45	.64	.90	1.3	1.4	2.0	2.5	3.2				
●	10	.075	.35	.50	.71	1.0	1.4	1.6	2.2	2.7	3.5					
●	11	.079	.39	.55	.78	1.1	1.6	1.7	2.5	3.0	3.9					
●	12	.082	.42	.60	.85	1.2	1.7	1.9	2.7	3.3	4.2					
●	15	.091	.53	.75	1.1	1.5	2.1	2.4	3.4	4.1	5.3					
●	20	.106	.71	1.0	1.4	2.0	2.8	3.2	4.5	5.5	7.1					
●	30	.129	1.1	1.5	2.1	3.0	4.2	4.7	6.7	8.2	10.6					
●	40	.149	1.4	2.0	2.8	4.0	5.7	6.3	8.9	11.0	14.1					

Other body types may be available. Contact your sales engineer for further information.
Highlighted column shows the rated pressure.

ENGLISH UNITS



PERFORMANCE DATA:
14784 UNIJET® SPRAY TIPS

Spray Angle at 40 psi	Tip Type	Capacity Size	Flow Rate Capacity (gallons per minute)						
	14784		10 psi	20 psi	40 psi	60 psi	80 psi	100 psi	200 psi
80°	●	40	2.0	2.8	4.0	4.9	5.7	6.3	8.9
	●	50	2.5	3.5	5.0	6.1	7.1	7.9	11.2
	●	60	3.0	4.2	6.0	7.3	8.5	9.5	13.4
	●	70	3.5	4.9	7.0	8.6	9.9	11.1	15.7
	●	100	5.0	7.1	10.0	12.2	14.1	15.8	22.4
	●	128	6.4	9.1	12.8	15.7	18.1	20.2	28.6
65°	●	40	2.0	2.8	4.0	4.9	5.7	6.3	8.9
	●	50	2.5	3.5	5.0	6.1	7.1	7.9	11.2
	●	60	3.0	4.2	6.0	7.3	8.5	9.5	13.4
	●	70	3.5	4.9	7.0	8.6	9.9	11.1	15.7
	●	100	5.0	7.1	10.0	12.2	14.1	15.8	22.4
50°	●	20	1.0	1.4	2.0	2.4	2.8	3.2	4.5
	●	40	2.0	2.8	4.0	4.9	5.7	6.3	8.9
	●	50	2.5	3.5	5.0	6.1	7.1	7.9	11.2
	●	60	3.0	4.2	6.0	7.3	8.5	9.5	13.4
	●	70	3.5	4.9	7.0	8.6	9.9	11.1	15.7
	●	100	5.0	7.1	10.0	12.2	14.1	15.8	22.4
40°	●	20	1.0	1.4	2.0	2.4	2.8	3.2	4.5
	●	50	2.5	3.5	5.0	6.1	7.1	7.9	11.2
	●	100	5.0	7.1	10.0	12.2	14.1	15.8	22.4
25°	●	50	2.5	3.5	5.0	6.1	7.1	7.9	11.2
	●	100	5.0	7.1	10.0	12.2	14.1	15.8	22.4
	●	120	6.0	8.5	12.0	14.7	17.0	19.0	26.8
	●	125	6.3	8.8	12.5	15.3	17.7	19.8	28.0
15°	●	100	5.0	7.1	10.0	12.2	14.1	15.8	22.4

Other body types may be available. Contact your sales engineer for further information.

DIMENSIONS AND WEIGHTS

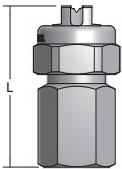
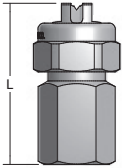
Nozzle	Nozzle Type	Inlet Conn. (in.)	L (in.)	Hex. (in.)	Net Weight (oz.)
	T (F) + TPU TT (M) + TPU	1/4	1.610	13/16	2.3
	T (F) + 13802 TT (M) + 13802	1/4	1.891	13/16	2.3

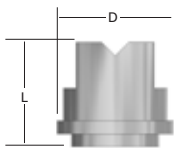
Nozzle	Spray Tip Type	L (in.)	D (in.)	Flats (in.)
	14784	1.00	1.00	.75

Based on the largest/heaviest version of each type.



**PERFORMANCE DATA
18897 VEEJET® SPRAY TIPS**

Spray Angle at 40 psi	Tip Type	Capacity Size	Equiv. Orifice Dia. (in.)	Flow Rate Capacity (gallons per minute)						
	18897			10 psi	20 psi	40 psi	60 psi	80 psi	100 psi	200 psi
110°	●	20	.109	1.0	1.4	2.0	2.5	2.8	3.2	4.5
	●	25	.125	1.3	1.8	2.5	3.1	3.5	4.0	5.6
	●	30	.140	1.5	2.1	3.0	3.7	4.2	4.7	6.7
	●	40	.156	2.0	2.8	4.0	4.9	5.7	6.3	9.0
	●	50	.171	2.5	3.5	5.0	6.1	7.1	7.9	11.2
	●	60	.187	3.0	4.2	6.0	7.3	8.5	9.5	13.4
	●	80	.218	4.0	5.6	8.0	9.8	11.3	12.6	17.9
	●	120	.265	6.0	8.5	12.0	14.7	17.0	19.0	27
	●	200	.343	10.0	14.1	20	25	28	32	44
80°	●	20	.109	1.0	1.4	2.0	2.5	2.8	3.2	4.5
	●	25	.125	1.3	1.8	2.5	3.1	3.5	4.0	5.6
	●	30	.140	1.5	2.1	3.0	3.7	4.2	4.7	6.7
	●	40	.156	2.0	2.8	4.0	4.9	5.7	6.3	9.0
	●	50	.171	2.5	3.5	5.0	6.1	7.1	7.9	11.2
	●	60	.187	3.0	4.2	6.0	7.3	8.5	9.5	13.4
	●	80	.218	4.0	5.6	8.0	9.8	11.3	12.6	17.9
	●	120	.265	6.0	8.5	12.0	14.7	17.0	19.0	27
	●	200	.343	10.0	14.1	20	25	28	32	44
65°	●	20	.109	1.0	1.4	2.0	2.5	2.8	3.2	4.5
	●	25	.125	1.3	1.8	2.5	3.1	3.5	4.0	5.6
	●	30	.140	1.5	2.1	3.0	3.7	4.2	4.7	6.7
	●	40	.156	2.0	2.8	4.0	4.9	5.7	6.3	9.0
	●	50	.171	2.5	3.5	5.0	6.1	7.1	7.9	11.2
	●	60	.187	3.0	4.2	6.0	7.3	8.5	9.5	13.4
	●	80	.218	4.0	5.6	8.0	9.8	11.3	12.6	17.9
	●	100	.250	5.0	7.1	10.0	12.2	14.1	15.8	22
	●	120	.265	6.0	8.5	12.0	14.7	17.0	19.0	27
	●	200	.343	10.0	14.1	20	25	28	32	44
50°	●	20	.109	1.0	1.4	2.0	2.5	2.8	3.2	4.5
	●	25	.125	1.3	1.8	2.5	3.1	3.5	4.0	5.6
	●	30	.140	1.5	2.1	3.0	3.7	4.2	4.7	6.7
	●	40	.156	2.0	2.8	4.0	4.9	5.7	6.3	9.0
	●	50	.171	2.5	3.5	5.0	6.1	7.1	7.9	11.2
	●	60	.187	3.0	4.2	6.0	7.3	8.5	9.5	13.4



PERFORMANCE DATA

ENGLISH UNITS
FLAT SPRAY NOZZLES

ENGLISH UNITS

PERFORMANCE DATA
18897 VEEJET® SPRAY TIPS

Spray Angle at 40 psi	Tip Type	Capacity Size	Equiv. Orifice Dia. (in.)	Flow Rate Capacity (gallons per minute)						
	18897			10 psi	20 psi	40 psi	60 psi	80 psi	100 psi	200 psi
50°	●	80	.218	4.0	5.6	8.0	9.8	11.3	12.6	17.9
	●	120	.265	6.0	8.5	12.0	14.7	17.0	19.0	27
	●	200	.343	10.0	14.1	20	25	28	32	44
40°	●	20	.109	1.0	1.4	2.0	2.5	2.8	3.2	4.5
	●	25	.125	1.3	1.8	2.5	3.1	3.5	4.0	5.6
	●	30	.140	1.5	2.1	3.0	3.7	4.2	4.7	6.7
	●	40	.156	2.0	2.8	4.0	4.9	5.7	6.3	9.0
	●	50	.171	2.5	3.5	5.0	6.1	7.1	7.9	11.2
	●	60	.187	3.0	4.2	6.0	7.3	8.5	9.5	13.4
	●	80	.218	4.0	5.6	8.0	9.8	11.3	12.6	17.9
	●	90	.234	4.5	6.4	9.0	11.0	12.7	14.2	20
	●	100	.250	5.0	7.1	10.0	12.2	14.1	15.8	22
	●	120	.265	6.0	8.5	12.0	14.7	17.0	19.0	27
	●	200	.343	10.0	14.1	20	25	28	32	44
25°	●	20	.109	1.0	1.4	2.0	2.5	2.8	3.2	4.5
	●	25	.125	1.3	1.8	2.5	3.1	3.5	4.0	5.6
	●	30	.140	1.5	2.1	3.0	3.7	4.2	4.7	6.7
	●	40	.156	2.0	2.8	4.0	4.9	5.7	6.3	9.0
	●	50	.171	2.5	3.5	5.0	6.1	7.1	7.9	11.2
	●	60	.187	3.0	4.2	6.0	7.3	8.5	9.5	13.4
	●	80	.218	4.0	5.6	8.0	9.8	11.3	12.6	17.9
	●	100	.250	5.0	7.1	10.0	12.2	14.1	15.8	22
	●	120	.265	6.0	8.5	12.0	14.7	17.0	19.0	27
	●	200	.343	10.0	14.1	20	25	28	32	44
15°	●	20	.109	1.0	1.4	2.0	2.5	2.8	3.2	4.5
	●	25	.125	1.3	1.8	2.5	3.1	3.5	4.0	5.6
	●	30	.140	1.5	2.1	3.0	3.7	4.2	4.7	6.7
	●	40	.156	2.0	2.8	4.0	4.9	5.7	6.3	9.0
	●	50	.171	2.5	3.5	5.0	6.1	7.1	7.9	11.2
	●	60	.187	3.0	4.2	6.0	7.3	8.5	9.5	13.4
	●	80	.218	4.0	5.6	8.0	9.8	11.3	12.6	17.9
	●	120	.265	6.0	8.5	12.0	14.7	17.0	19.0	27



**PERFORMANCE DATA
49803 AND 49807 VEEJET® SPRAY TIPS**

Spray Angle at 40 psi	Tip Type		Capacity Size	Flow Rate Capacity (gallons per minute)					
	49803	49807		20 psi	40 psi	60 psi	80 psi	100 psi	150 psi
110°		●	0067	.05	.067	.08	.09	.11	.13
		●	02	.14	.20	.25	.28	.32	.39
		●	04	.28	.40	.49	.57	.63	.78
		●	06	.42	.60	.73	.85	.95	1.16
		●	08	.56	.80	.98	1.13	1.26	1.55
	●		40	2.83	4.00	4.89	5.65	6.32	7.74
	●		50	3.53	5.00	6.12	7.07	7.90	9.68
95°		●	02	.14	.20	.25	.28	.32	.39
		●	04	.28	.40	.49	.57	.63	.78
		●	06	.42	.60	.73	.85	.95	1.16
		●	08	.56	.80	.98	1.13	1.26	1.55
	●		10	.71	1.00	1.22	1.41	1.58	1.94
	●		15	1.06	1.50	1.84	2.12	2.37	2.90
	●		20	1.41	2.00	2.45	2.83	3.16	3.87
	●		30	2.12	3.00	3.67	4.25	4.74	5.80
	●		40	2.83	4.00	4.89	5.65	6.32	7.74
	●		50	3.53	5.00	6.12	7.07	7.90	9.68
80°		●	01	.07	.10	.12	.14	.16	.19
		●	02	.14	.20	.25	.28	.32	.39
		●	04	.28	.40	.49	.57	.63	.78
		●	06	.42	.60	.73	.85	.95	1.16
		●	08	.56	.80	.98	1.13	1.26	1.55
	●		10	.71	1.00	1.22	1.41	1.58	1.94
	●		15	1.06	1.50	1.84	2.12	2.37	2.90
	●		20	1.41	2.00	2.45	2.83	3.16	3.87
	●		30	2.12	3.00	3.67	4.25	4.74	5.80
	●		40	2.83	4.00	4.89	5.65	6.32	7.74
	●		50	3.53	5.00	6.12	7.07	7.90	9.68

ENGLISH UNITS



PERFORMANCE DATA

ENGLISH UNITS
FLAT SPRAY NOZZLES

ENGLISH UNITS

**PERFORMANCE DATA
49803 AND 49807 VEEJET® SPRAY TIPS**

Spray Angle at 40 psi	Tip Type		Capacity Size	Flow Rate Capacity (gallons per minute)					
	49803	49807		20 psi	40 psi	60 psi	80 psi	100 psi	150 psi
75°	●		50	3.53	5.00	6.12	7.07	7.90	9.68
65°		●	015	.11	.15	.18	.21	.24	.29
		●	02	.14	.20	.25	.28	.32	.39
		●	04	.28	.40	.49	.57	.63	.78
		●	06	.42	.60	.73	.85	.95	1.16
		●	08	.56	.80	.98	1.13	1.26	1.55
		●	10	.71	1.00	1.22	1.41	1.58	1.94
		●	15	1.06	1.50	1.84	2.12	2.37	2.90
		●	20	1.41	2.00	2.45	2.83	3.16	3.87
		●	30	2.12	3.00	3.67	4.25	4.74	5.80
		●	40	2.83	4.00	4.89	5.65	6.32	7.74
		●	50	3.53	5.00	6.12	7.07	7.90	9.68
60°	●		50	3.53	5.00	6.12	7.07	7.90	9.68
50°	●		30	2.12	3.00	3.67	4.25	4.74	5.80
	●		50	3.53	5.00	6.12	7.07	7.90	9.68
	●		70	4.95	7.00	8.57	9.90	11.07	13.56
45°	●		50	3.53	5.00	6.12	7.07	7.90	9.68
25°		●	0067	.05	.067	.08	.09	.11	.13
		●	015	.11	.15	.18	.21	.24	.29
15°		●	01	.07	.10	.12	.14	.16	.19
5°		●	01	.07	.10	.12	.14	.16	.19



**PERFORMANCE DATA
58606 VEEJET® SPRAY TIPS**

Spray Angle at 40 psi	Tip Type	Capacity Size	Flow Rate Capacity (gallons per minute)						
	45478		10 psi	20 psi	40 psi	60 psi	80 psi	100 psi	200 psi
110°	●	150	7.5	10.6	15.0	18.4	21.2	23.7	33.5
	●	200	10.0	14.1	20.0	25.0	28.0	32.0	44.0
80°	●	150	7.5	10.6	15.0	18.4	21.2	23.7	33.5
	●	200	10.0	14.1	20.0	25.0	28.0	32.0	44.0
65°	●	150	7.5	10.6	15.0	18.4	21.2	23.7	33.5
	●	200	10.0	14.1	20.0	25.0	28.0	32.0	44.0
	●	250	12.5	17.7	25.0	30.6	35.4	39.5	55.9
50°	●	150	7.5	10.6	15.0	18.4	21.2	23.7	33.5
	●	180	9.0	12.7	18.0	22.0	25.5	28.5	40.2
	●	200	10.0	14.1	20.0	25.0	28.0	32.0	44.0
	●	250	12.5	17.7	25.0	30.6	35.4	39.5	55.9
40°	●	150	7.5	10.6	15.0	18.4	21.2	23.7	33.5
	●	200	10.0	14.1	20.0	25.0	28.0	32.0	44.0
25°	●	130	6.5	9.2	13.0	15.9	18.4	20.6	29.1
	●	140	7.0	9.9	14.0	17.1	19.8	22.1	31.3
	●	150	7.5	10.6	15.0	18.4	21.2	23.7	33.5
	●	200	10.0	14.1	20.0	25.0	28.0	32.0	44.0
15°	●	180	9.0	12.7	18.0	22.0	25.5	28.5	40.2
	●	200	10.0	14.1	20.0	25.0	28.0	32.0	44.0

**PERFORMANCE DATA
20799 VEEJET® SPRAY TIPS**

Spray Angle at 40 psi	Tip Type	Capacity Size	Equiv. Orifice Dia. (in.)	Flow Rate Capacity (gallons per minute)						
	20799			10 psi	20 psi	40 psi	60 psi	80 psi	100 psi	200 psi
120°	●	12.5	.087	.63	.88	1.25	1.5	1.8	2.0	2.8
	●	15	.093	.75	1.1	1.5	1.8	2.1	2.4	3.4
	●	20	.109	1.0	1.4	2.0	2.4	2.8	3.2	4.5
	●	25	.125	1.3	1.8	2.5	3.1	3.5	4.0	5.6
	●	30	.140	1.5	2.1	3.0	3.7	4.2	4.7	6.7
	●	40	.156	2.0	2.8	4.0	4.9	5.7	6.3	8.9
	●	50	.171	2.5	3.5	5.0	6.1	7.1	7.9	11.2
	●	60	.187	3.0	4.2	6.0	7.3	8.5	9.5	13.4
	●	80	.218	4.0	5.7	8.0	9.8	11.3	12.6	17.9
	●	100	.250	5.0	7.1	10.0	12.2	14.1	15.8	22
	●	125	.265	6.3	8.8	12.5	15.3	17.7	19.8	28
	●	200	.343	10.0	14.1	20	24	28	32	45



PERFORMANCE DATA

**ENGLISH UNITS
FLAT SPRAY NOZZLES**

ENGLISH UNITS

**PERFORMANCE DATA
FSUN-S VEEJET® SPRAY TIPS**

Spray Angle	Tip Retainer Size (in.)	Tip Type	Capacity Size	Equiv. Orifice Dia. (in.)	Flow Rate Capacity (gallons per minute)						
		FSUN-S			10 psi	20 psi	40 psi	60 psi	80 psi	100 psi	200 psi
20°, 30°, 45°, 60°, 75°, 90°, 120°	3/8	•	.6	.031	.06	.08	.12	.14	.17	.19	.26
		•	1	.039	.10	.14	.20	.24	.28	.31	.44
		•	1.5	.047	.15	.21	.29	.36	.42	.47	.66
		•	2	.055	.20	.28	.39	.48	.55	.62	.88
		•	2.5	.059	.25	.35	.49	.60	.69	.78	1.1
		•	3	.067	.29	.42	.59	.72	.83	.93	1.3
		•	4	.079	.39	.55	.78	1.0	1.1	1.2	1.8
		•	5	.087	.49	.69	1.0	1.2	1.4	1.6	2.2
		•	6	.098	.59	.83	1.2	1.4	1.7	1.9	2.6
		•	7.5	.106	.74	1.0	1.5	1.8	2.1	2.3	3.3
		•	10	.118	1.0	1.4	2.0	2.4	2.8	3.1	4.4
		•	13	.138	1.3	1.8	2.6	3.1	3.6	4.0	5.7
		•	16	.157	1.6	2.2	3.1	3.8	4.4	5.0	7.0
		•	20	.177	2.0	2.8	3.9	4.8	5.5	6.2	8.8
		•	25	.197	2.5	3.5	4.9	6.0	6.9	7.8	11.0
		•	32	.217	3.1	4.4	6.3	7.7	8.9	9.9	14.0
		•	40	.236	3.9	5.5	7.8	9.6	11.1	12.4	17.5
20°, 30°, 45°, 60°, 75°, 90°, 120°	3/4	•	10	.118	1.0	1.4	2.0	2.4	2.8	3.1	4.4
		•	13	.138	1.3	1.8	2.6	3.1	3.6	4.0	5.7
		•	16	.157	1.6	2.2	3.1	3.8	4.4	5.0	7.0
		•	20	.177	2.0	2.8	3.9	4.8	5.5	6.2	8.8
		•	25	.197	2.5	3.5	4.9	6.0	6.9	7.8	11.0
		•	32	.217	3.1	4.4	6.3	7.7	8.9	9.9	14.0
		•	40	.236	3.9	5.5	7.8	9.6	11.1	12.4	17.5
		•	50	.276	4.9	6.9	9.8	12.0	13.9	15.5	21.9
		•	63	.315	6.2	8.7	12.4	15.1	17.5	19.5	27.6
		•	80	.354	7.8	11.1	15.7	19.2	22.2	24.8	35.1
		•	100	.394	9.8	13.9	19.6	24.0	27.7	31.0	43.9
		•	130	.433	12.8	18.0	25.5	31.2	36.1	40.3	57.0
20°, 30°, 45°, 60°, 75°, 90°, 120°	1-1/4	•	160	.472	15.7	22.2	31.4	38.4	44.4	49.6	70.2
		•	63	.315	6.2	8.7	12.4	15.1	17.5	19.5	27.6
		•	80	.354	7.8	11.1	15.7	19.2	22.2	24.8	35.1
		•	100	.394	9.8	13.9	19.6	24.0	27.7	31.0	43.9
		•	130	.433	12.8	18.0	25.5	31.2	36.1	40.3	57.0
		•	160	.472	15.7	22.2	31.4	38.4	44.4	49.6	70.2
		•	200	.512	19.6	27.7	39.2	48.1	55.5	62.0	87.7
•	250	.591	24.5	34.7	49.0	60.1	69.4	77.6	109.7		



DIMENSIONS AND WEIGHTS

Spray Tip	Spray Tip Type	L (in.)	D (in.)
	18897	.563	.937
	20799	.828	.937
	58606	3.7	1.0
	49803, 49807	.464	.578

Based on the largest/heaviest version of each type.

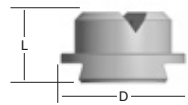
Spray Tip	Spray Tip Type	Tip Retainer Size (in.)	L (in.)	D (in.)
	FSUN-S	3/8	.47	.58
		3/4	.55	.94
		1-1/4	.87	1.52

Based on the largest/heaviest version of each type.

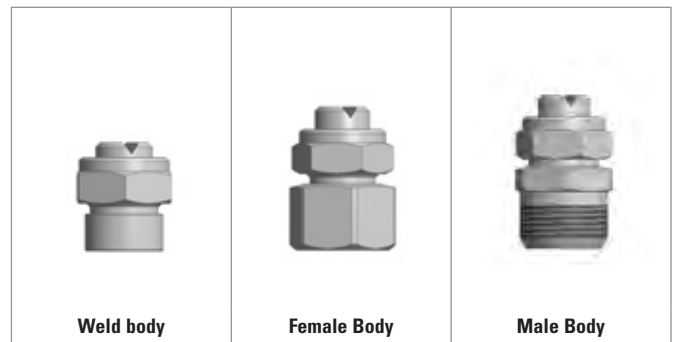

Dovetail spray tips can be used on a variety of body types. Please contact your sales engineer for body options and dimensions.

PERFORMANCE DATA
G, GG, H, HH, HF, GA AND GGA FULLJET® NOZZLES

Inlet Conn. (in.)	Nozzle Type							Capacity Size	Orifice Dia. Nom. (in.)	Max. Free Passage Dia. (in.)	Flow Rate Capacity (gallons per minute)							Spray Angle (°)			
	Standard				Angle						5 psi	7 psi	10 psi	20 psi	40 psi	80 psi	100 psi	150 psi	7 psi	20 psi	80 psi
	G	GG	H	HH	HF	GA	GGA														
1/8	•	•		•				1	.031	.025	-	-	.10	.14	.19	.26	.29	.35	-	58	53
	•	•		•				1.5	.044	.025	.11	.13	.15	.21	.28	.39	.43	.52	52	65	59
	•	•		•		•	•	2	.048	.040	.15	.17	.20	.28	.38	.52	.58	.70	43	50	46
	•	•		•		•	•	3	.063	.040	.22	.25	.30	.41	.57	.78	.87	1.0	52	65	59
	•	•		•		•	•	3.5	.063	.050	.25	.30	.35	.48	.66	.91	1.0	1.2	43	50	46
						•	•	3.9	.078	.040	.28	.33	.39	.54	.74	1.0	1.1	1.4	77	84	79
	•	•		•		•	•	5	.078	.050	.36	.42	.50	.69	.95	1.3	1.4	1.7	52	65	59
1/4						•	•	6.1	.094	.050	.44	.52	.61	.84	1.2	1.6	1.8	2.1	69	74	68
	•	•		•		•	•	6.5	.094	.063	.47	.55	.65	.89	1.2	1.7	1.9	2.3	45	50	46
	•	•		•		•	•	10	.109	.063	.73	.85	1.0	1.4	1.9	2.6	2.9	3.5	58	67	61
3/8				•		•	•	12.5	.125	.063	.91	1.1	1.3	1.7	2.4	3.3	3.6	4.3	69	74	68
	•	•		•		•	•	9.5	.109	.094	.69	.81	.95	1.3	1.8	2.5	2.7	3.3	45	50	46
	•	•		•		•	•	15	.141	.094	1.1	1.3	1.5	2.1	2.8	3.9	4.3	5.2	64	67	61
1/2						•	•	20	.156	.109	1.5	1.7	2.0	2.8	3.8	5.2	5.8	7.0	76	80	73
	•	•		•		•	•	22	.188	.109	1.6	1.9	2.2	3.0	4.2	5.7	6.3	7.6	87	90	82
	•	•		•		•	•	16	.141	.125	1.2	1.4	1.6	2.2	3.0	4.2	4.6	5.6	48	50	46
	•	•		•		•	•	25	.188	.125	1.8	2.1	2.5	3.4	4.7	6.5	7.2	8.7	64	67	61
	•	•		•		•	•	32	.203	.141	2.3	2.7	3.2	4.4	6.1	8.3	9.2	11.1	72	75	68
3/4						•	•	40	.250	.141	2.9	3.4	4.0	5.5	7.6	10.4	11.5	13.9	88	91	83
						•	•	50	.266	.156	3.6	4.2	5.0	6.9	9.5	13.0	14.4	17.4	91	94	86
			•	•				2.5	.188	.172	2.1	2.5	2.9	4.1	5.6	7.7	8.5	10.2	48	50	46
1			•	•				4.0	.250	.172	3.4	4.0	4.7	6.5	8.9	12.3	13.6	16.4	67	70	63
			•	•				7.0	.328	.203	6.0	7.0	8.2	11.3	15.6	21	24	29	89	92	84
			•	•				4.2	.234	.219	3.6	4.2	4.9	6.8	9.4	12.9	14.3	17.2	48	50	46
			•	•				7.0	.328	.219	6.0	7.0	8.2	11.3	15.6	21	24	29	67	68	62
			•	•				8.0	.375	.219	6.9	8.0	9.4	13.0	17.8	25	27	33	72	81	82
1-1/4			•	•				10	.469	.219	8.6	10.0	11.8	16.2	22	31	34	41	78	90	94
			•	•				12	.469	.250	10.3	12.0	14.1	19.4	27	37	41	49	89	92	84
			•					6	.297	.250	5.1	6.0	7.1	9.7	13.4	18.4	20	25	48	50	44
			•					10	.375	.250	8.6	10.0	11.8	16.2	22	31	34	41	64	67	58
			•					12	.422	.250	10.3	12.0	14.1	19.4	27	37	41	49	66	70	60
			•					14	.484	.250	12.0	14.0	16.5	23	31	43	48	57	77	80	70
1-1/4			•					16	.500	.313	13.7	16.0	18.9	26	36	49	54	66	73	76	66
			•					20	.594	.313	17.1	20	24	32	45	61	68	82	90	93	81

Maximum Free Passage Diameter is the maximum diameter as listed of foreign matter that can pass through the nozzle without clogging. Highlighted column shows the rated pressure.



**PERFORMANCE DATA
G, GG, H, HH, HF, GA AND GGA FULLJET® NOZZLES**

Inlet Conn. (in.)	Nozzle Type						Capacity Size	Orifice Dia. Nom. (in.)	Max. Free Passage Dia. (in.)	Flow Rate Capacity (gallons per minute)								Spray Angle (°)		
	Standard				Angle					5 psi	7 psi	10 psi	20 psi	40 psi	80 psi	100 psi	150 psi	7 psi	20 psi	80 psi
	G	GG	H	HH	HF	GA				GGA										
1-1/2			•				10	.375	.344	8.6	10.0	11.8	16.2	22	31	34	41	48	50	44
			•				16	.500	.344	13.7	16.0	18.9	26	36	49	54	66	72	74	64
			•				20	.563	.344	17.1	20	24	32	45	61	68	82	74	76	66
			•				30*	.719	.406	26	30	35	49	67	92	102	123	91	94	82
2			•				17	.500	.438	14.6	17.0	20	28	38	52	58	70	49	50	44
			•				30	.688	.438	26	30	35	49	67	92	102	123	72	74	64
			•				35	.750	.438	30	35	41	57	78	107	119	143	75	77	68
			•				40	.828	.438	34	40	47	65	89	123	136	164	78	80	70
			•				50*	.938	.563	43	50	59	81	111	153	170	205	83	85	75
			•				60*	1.125	.563	51	60	71	97	134	184	204	246	98	100	86
2-1/2			•				25	.594	.563	21	25	29	41	56	77	85	102	49	50	44
			•				50	.875	.563	43	50	59	81	111	153	170	205	72	74	64
			•				60	.969	.563	51	60	71	97	134	184	204	246	76	78	68
			•				70	1.125	.563	60	70	82	113	156	215	238	287	79	82	72
			•				80	1.125	.688	69	80	94	130	178	245	272	328	86	88	77
			•				90	1.250	.688	77	90	106	146	201	276	306	369	95	97	84
3			•				42	.750	.688	36	42	49	68	94	129	143	172	49	50	44
			•				80	1.094	.688	69	80	94	130	178	245	272	328	81	84	73
			•				90	1.188	.688	77	90	106	146	201	276	306	369	86	89	77
			•				100	1.281	.688	86	100	118	162	223	307	340	410	92	95	83
			•				110	1.938	.813	93	110	131	186	263	372	416	509	86	89	77
			•				120	1.375	.813	101	120	143	203	287	406	454	555	102	105	89
4			•		•		160	1.688	.750	137	160	189	259	357	491	544	655	87	90	70
			•		•		180	1.859	.875	154	180	212	292	401	552	612	737	92	95	83
			•		•		200	2.0	1.0	171	200	236	324	446	613	680	819	97	100	87
			•		•		210	2.156	1.0	180	210	247	340	468	644	714	860	102	105	91
5			•		•		250	1.875	1.125	214	250	295	405	557	767	850	1024	89	91	80
			•		•		280	2.078	1.125	240	280	330	454	624	859	952	1147	93	96	84
			•		•		320	2.688	1.375	274	320	377	519	713	981	1087	1310	97	100	87
			•		•		330	2.844	1.375	283	330	389	535	736	1012	1121	1351	102	105	91
6			•		•		350	2.406	1.625	300	350	412	567	780	1073	1189	1433	87	90	78
			•		•		400	2.719	1.625	343	400	471	648	892	1227	1359	1638	92	95	83
			•		•		450	3.031	1.750	385	450	530	729	1003	1380	1529	1843	97	100	87
			•		•		480	3.219	1.750	411	480	566	778	1070	1472	1631	1966	102	105	91
8			•		•		500	2.750	1.875	428	500	589	810	1115	1533	1699	2048	78	80	70
			•		•		600	3.156	1.875	514	600	707	972	1338	1840	2039	2457	86	88	77
			•		•		700	3.594	1.875	600	700	825	1135	1561	2147	2379	2867	92	95	83
			•		•		800	4.031	2.250	685	800	943	1297	1784	2453	2719	3276	102	105	91
10					•		800	3.344	2.500	685	800	943	1297	1784	2453	2719	3276	78	80	70
					•		1000	3.969	2.500	857	1000	1178	1621	2229	3067	3398	4095	86	89	77
					•		1200	4.797	2.625	1028	1200	1414	1945	2675	3680	4078	4914	97	100	87
					•		1300	5.313	2.625	1114	1300	1532	2107	2898	3987	4418	5324	103	106	92

Maximum Free Passage Diameter is the maximum diameter as listed of foreign matter that can pass through the nozzle without clogging.
*These capacity sizes are not available for H in polypropylene.

Highlighted column shows the rated pressure.

ENGLISH UNITS

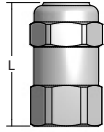
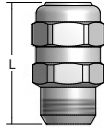

DIMENSIONS AND WEIGHTS

Nozzle	Nozzle Type	Inlet Conn. (in.)	L (in.)	Hex. (in.)	Net Weight (oz.)
	G (F)	1/8	1.219	9/16	1
		1/4	1.469	11/16	1.5
		3/8	1.812	13/16	2.5
		1/2	2.250	1	6
	GG (M)	1/8	1.281	9/16	.8
		1/4	1.563	11/16	1.5
		3/8	1.844	13/16	2.5
		1/2	2.219	1	6

Based on the largest/heaviest version of each type.

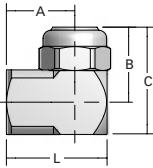
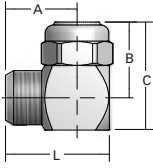
Nozzle	Nozzle Type	Inlet Conn. (in.)	L (in.)	A (in.)	B (in.)	C (in.)	Net Weight (oz.)
	GA (F)	1/8	.910	.630	.563	.844	1.5
		1/4	1.130	.790	.781	1.125	2
		3/8	1.281	.875	1.188	1.594	3.3
		1/2	1.563	1.063	1.359	1.859	6.3
	GGA (M)	1/8	.940	.660	.563	.844	1.5
		1/4	1.160	.820	.781	1.125	2
		3/8	1.313	.906	1.188	1.594	3.3
		1/2	1.609	1.109	1.359	1.859	6.3

Based on the largest/heaviest version of each type.

DIMENSIONS AND WEIGHTS

Nozzle	Nozzle Type	Inlet Conn. (in.)	L (in.)	D (Dia.) (in.)	Net Weight (oz.)
	H (F)	3/4	2.188	1.250	7.3
		1	2.734	1.500	12.4
	H (F) Cast	1-1/4	3.440	2.063 oct.	25.7
		1-1/2	4.063	2.313 oct.	25.4
		2	5.440	3.000 oct.	39
		2-1/2	6.313	3.438 oct.	76
		3	7.375	4.063 oct.	95.3
		4	9.563	5.438 oct.	12 lbs.
	H (F) Cast (Standard angle only) Wide angle not available in Cast for these sizes	5	11.563	6.750 oct.	30.8 lbs.
		6	14.375	8.000 oct.	49 lbs.
	HF (Flange)	4	8.125	8.750	28.8 lbs.
		5	10.560	10.000	34.3 lbs.
		6	12.625	11.000	49 lbs.
		8	16.625	13.500	120 lbs.
		10	20.750	16.000	193 lbs.
	HH (M)	1/8	.875	.500	.5
		1/4	.880	.531	.5
		3/8	.940	.656	1
		1/2	1.156	.813	1.5
		3/4	1.531	1.063	3.5
		1	2.031	1.313	7

Based on the largest/heaviest version of each type.

PERFORMANCE DATA

**ENGLISH UNITS
FULL CONE NOZZLES**

ENGLISH UNITS

**PERFORMANCE DATA
HMFP AND HHMFP MAXIMUM FREE PASSAGE FULLJET® NOZZLES**

Inlet Conn. (in.)	Nozzle Type		Capacity Size	Approx. Free Passage Dia. (in.)	Flow Rate Capacity (gallons per minute)				Spray Angle (°)					
					60° Series		90° Series		115° Series					
	HMFP	HHMFP			10 psi	20 psi	40 psi	80 psi	10 psi	40 psi	10 psi	40 psi	10 psi	40 psi
3/8	●	●	14	.125	1.4	1.8	2.4	3.2	60	62	90	84	115	100
	●	●	22	.156	2.2	2.9	3.8	5.1	60	62	90	84	115	100
	●	●	32	.188	3.2	4.2	5.6	7.4	60	62	90	84	115	100
1/2	●	●	32	.188	3.2	4.2	5.6	7.4	60	62	90	84	115	100
	●	●	51	.219	5.1	6.7	8.9	11.7	60	62	90	84	115	100
	●	●	57	.250	5.7	7.5	9.9	13.1	60	62	90	84	115	100
3/4	●	●	70	.281	7.0	9.2	12.2	16.1	60	62	90	84	115	100
	●	●	84	.313	8.4	11.1	14.6	19.3	60	62	90	84	115	100
	●	●	100	.344	10.0	13.2	17.4	23	60	62	90	84	115	100
	●	●	120	.375	12.0	15.8	21	28	60	62	90	84	115	100
1	●	●	120	.375	12.0	15.8	21	28	60	62	90	84	115	100
	●	●	150	.406	15.0	19.5	25	33	60	62	90	88	115	105
	●	●	170	.437	17.0	22	29	37	60	62	90	88	115	105
1-1/4	●	●	170	.437	17.0	22	29	37	60	62	90	88	115	105
	●	●	200	.469	20	26	34	44	60	62	90	88	115	105
	●	●	220	.500	22	29	37	48	60	62	90	88	115	105
	●	●	240	.531	24	31	41	53	60	62	90	88	115	105
	●	●	260	.562	26	34	44	57	60	62	90	88	115	105
	●	●	240	.54	24	32	43	58	60	59	89	89	108	104
1-1/2	●	●	260	.558	26	35	47	63	62	61	90	92	113	103
	●	●	280	.571	28	38	50	68	62	62	89	91	113	107
	●	●	300	.59	30	42	58	80	63	62	93	92	114	108
	●	●	350	.63	35	48	67	93	63	63	91	93	117	113
	●	●	400	.66	40	55	77	106	64	64	92	93	120	115
	●	●	450	.7	45	62	86	119	65	63	92	91	117	116
2	●	●	500	.76	50	70	97	135	59	58	90	86	103	98
	●	●	600	.82	60	84	116	162	61	58	89	86	108	102
	●	●	700	.86	70	98	136	189	62	57	92	91	114	106
	●	●	800	.97	80	111	155	216	60	57	93	89	113	111
2-1/2	●	●	1000	1	100	137	188	258	61	58	92	90	112	112
	●	●	1200	1.21	120	165	226	309	63	59	94	91	110	108
	●	●	1400	1.36	140	192	263	361	62	60	93	92	113	111
	●	●	1700	1.41	170	233	320	438	62	60	89	88	112	110
3	●	●	1800	1.55	180	242	325	436	61	59	90	92	112	108
	●	●	2000	1.73	200	269	361	485	63	61	93	91	112	109
	●	●	2400	2.2	240	322	433	582	62	60	95	93	114	111

Approximate Free Passage Diameter is the approximate diameter as listed of foreign matter that can pass through the nozzle without clogging.

Highlighted column shows the rated pressure.



DIMENSIONS AND WEIGHTS

Nozzle	Nozzle Type	Inlet Conn. (in.)	Spray Angle	Capacity Size	L (in.)	Hex. (in.)	Net Weight (oz.)
	HMFP (F)	3/8	60°, 90°, 115°	14, 22	1.460	13/16	2.4
			60°, 90°, 115°	32	1.701	13/16	2.5
		1/2	60°, 90°, 115°	32	1.770	1	4.5
			60°, 90°, 115°	51, 57	2.120	1	4.6
		3/4	60°, 90°, 115°	70	2.400	1-1/4	8.9
			60°, 90°, 115°	84	2.637	1-3/8	12.6
			60°, 90°, 115°	100	2.894	1-3/8	13.3
		1	60°, 90°, 115°	120	3.070	1-3/8	12.9
		1	60°, 90°, 115°	120, 150, 170	3.250	1-3/4	22.5
		1-1/4	60°, 90°, 115°	170, 200, 220, 240, 260	3.750	2	30.5
1-1/2	60°, 90°, 115°	240, 260, 280, 300, 350, 400, 450	4.380	2-3/16	35.3		
	HMFP (F)	2	60°, 90°, 115°	500, 600, 700, 800	6.528	2-3/4 dia.	52.9
		2-1/2	60°, 90°, 115°	1000, 1200, 1400, 1700	8.000	3-13/16 dia.	93.5
		3	60°, 90°, 115°	1800, 2000, 2400	9.440	4-3/16 dia.	114.6
	HHMFP (M)	3/8	60°, 90°, 115°	14, 22	1.000	11/16	1.4
			60°, 90°, 115°	32	1.701	3/4	2
		1/2	60°, 90°, 115°	32	1.225	7/8	2.4
			60°, 90°, 115°	51, 57	2.198	1	4.9
		3/4	60°, 90°, 115°	70	1.810	1-1/8	5
			60°, 90°, 115°	84	2.713	1-3/8	11.5
			60°, 90°, 115°	100	2.980	1-3/8	12.1
		1	60°, 90°, 115°	120	3.100	1-3/8	11.5
		1	60°, 90°, 115°	120, 150, 170	3.250	1-3/4	22.5
		1-1/4	60°, 90°, 115°	170, 200, 220, 240, 260	3.750	2	32
1-1/2	60°, 90°, 115°	240, 260, 280, 300, 350, 400, 450	4.380	2-3/16	36.7		
	HHMFP (M)	2	60°, 90°, 115°	500, 600, 700, 800	6.528	2-3/4 dia.	52.9
		2-1/2	60°, 90°, 115°	1000, 1200, 1400, 1700	8.000	3-13/16 dia.	93.5
		3	60°, 90°, 115°	1800, 2000, 2400	9.440	4-3/16 dia.	114.6

Based on the largest/heaviest version of each type.

ENGLISH UNITS



PERFORMANCE DATA

**ENGLISH UNITS
FULL CONE NOZZLES**

ENGLISH UNITS

**PERFORMANCE DATA
HHSJ SPIRALJET® NOZZLES**

Inlet Conn. (in.)	Nozzle Type	Spray Angle at 10 psi					Capacity Size	Orifice Dia. Nom. (in.)	Max. Free Passage Dia. (in.)	Flow Rate Capacity (gallons per minute)				
		HHSJ	60°	90°	120°	150°				170°	10 psi	20 psi	40 psi	100 psi
1/4	•	•	•	•			07	.094	.094	.70	.99	1.4	2.2	4.4
	•	•	•	•	•	•	13	.125	.125	1.3	1.8	2.6	4.1	8.2
	•	•	•	•	•	•	20	.156	.125	2.0	2.8	4.0	6.3	12.6
3/8	•	•					07	.094	.094	.70	.99	1.4	2.2	4.4
	•	•					13	.125	.125	1.3	1.8	2.6	4.1	8.2
	•	•					20	.156	.125	2.0	2.8	4.0	6.3	12.6
	•	•	•	•	•	•	30	.188	.125	3.0	4.2	6.0	9.5	19.0
	•	•	•	•	•	•	40	.219	.125	4.0	5.7	8.0	12.6	25
	•	•	•	•	•	•	53	.250	.125	5.3	7.5	10.6	16.8	34
	•	•	•	•	•	•	82	.313	.125	8.2	11.6	16.4	26	52
1/2	•	•	•	•	•	•	120	.375	.188	12.0	17.0	24	38	76
	•	•	•	•	•	•	164	.438	.188	16.4	23	33	52	104
	•					•	210	.500	.188	21	30	42	66	133
3/4	•	•	•	•	•	•	210	.500	.188	21	30	42	66	133
1	•	•	•	•	•	•	340	.625	.250	34	48	68	108	215
	•	•	•	•	•	•	470	.750	.250	47	66	94	149	297
1-1/2	•	•	•	•	•	•	640	.875	.313	64	91	128	202	405
	•	•	•	•	•	•	820	1.000	.313	82	116	164	259	519
	•	•	•	•	•	•	960	1.125	.313	96	136	192	304	607
2	•	•	•	•	•	•	1400	1.375	.438	140	198	280	443	885
	•	•	•	•	•	•	1780	1.500	.438	178	252	356	563	1126
3	•	•	•	•			2560	1.750	.563	256	362	512	810	1619
	•	•	•	•			3360	2.000	.563	336	475	672	1063	2125
4	•	•	•	•			5250	2.500	.625	525	742	1050	1660	3320

Maximum Free Passage Diameter is the maximum diameter as listed of foreign matter that can pass through the nozzle without clogging.
Highlighted column shows the rated pressure.



**PERFORMANCE DATA
HHSJX SPIRALJET® NOZZLES**

Inlet Conn. (in.)	Nozzle Type	Spray Angle at 10 psi		Capacity Size	Orifice Dia. Nom. (in.)	Max. Free Passage Dia. (in.)	Flow Rate Capacity (gallons per minute)				
		90°	120°				10 psi	20 psi	40 psi	100 psi	400 psi
3/8	•	•	•	30	.188	.188	3.0	4.2	6.0	9.5	19.0
	•	•	•	40	.219	.219	4.0	5.7	8.0	12.6	25
	•	•	•	53	.250	.250	5.3	7.5	10.6	16.8	34
	•	•	•	82	.313	.313	8.2	11.6	16.4	26	52
1/2	•	•	•	120	.375	.375	12.0	17.0	24	38	76
	•	•	•	164	.438	.438	16.4	23	33	52	104
3/4	•	•	•	210	.500	.500	21	30	42	66	133
1	•	•	•	340	.625	.625	34	48	68	108	215
	•	•	•	470	.750	.750	47	66	94	149	297
1-1/2	•	•	•	640	.875	.875	64	91	128	202	405
	•	•	•	820	1.000	1.000	82	116	164	259	519
	•	•	•	960	1.125	1.125	96	136	192	304	607
2	•	•	•	1400	1.375	1.375	140	198	280	443	885
	•	•	•	1780	1.500	1.500	178	252	356	563	1126

Maximum Free Passage Diameter is the maximum diameter as listed of foreign matter that can pass through the nozzle without clogging. Highlighted column shows the rated pressure.

DIMENSIONS AND WEIGHTS

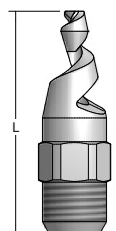
Nozzle	Nozzle Type	Inlet Conn. (in.)	L (in.)	Hex. (in.)	Net Weight (oz.)
	HHSJ (M)	1/4	2.125	9/16	1
		3/8	2.375	11/16	1.8
		1/2	3.125	7/8	3.5
		3/4	3.438	1-1/16	5.4
		1	4.563	1-3/8	10
		1-1/2	6.750	2	27
		2	6.875	2-1/2	35
		3	11.875	3-3/4	92
		4	9.000	4-1/2	10.3 lbs.

Based on the largest/heaviest version of each type.

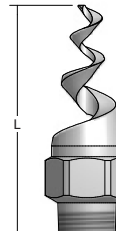
Nozzle	Nozzle Type	Inlet Conn. (in.)	L (in.)	Hex. (in.)	Net Weight (oz.)
	HHSJX (M)	3/8	2.750	7/8	3
		1/2	3.375	1-1/16	4.5
		3/4	4.625	1-3/8	8
		1	5.125	1-3/4	18
		1-1/2	6.750	2	30
		2	11.000	3	88

Based on the largest/heaviest version of each type.



PERFORMANCE DATA
VK FULLJET® NOZZLES

Inlet Conn. (in.)	Nozzle Type	Capacity Size	Flow Rate Capacity (gallons per minute)							Max. Free Passage (in.) at Spray Angle (°)			
			10 psi	20 psi	40 psi	60 psi	80 psi	100 psi	200 psi	45	60	90	120
3/8 F	VK	1.5	.16	.22	.30	.36	.41	.46	.63	.028	.043	.031	.030
	•	2	.21	.29	.40	.48	.55	.61	.84	.031	.047	.031	.031
	•	2.5	.27	.37	.50	.61	.69	.77	1.1	.047	.045	.039	.035
	•	3.5	.37	.51	.70	.85	1.0	1.1	1.5	.049	.047	.043	.039
	•	4	.42	.58	.80	.97	1.1	1.2	1.7	.055	.049	.045	.043
	•	4.5	.48	.66	.90	1.1	1.2	1.4	1.9	.055	.051	.045	.043
	•	5	.53	.73	1.0	1.2	1.4	1.5	2.1	.061	.059	.047	.047
	•	6	.64	.88	1.2	1.5	1.7	1.8	2.5	.063	.063	.055	.051
	•	7	.74	1.0	1.4	1.7	1.9	2.1	2.9	.071	.065	.061	.055
	•	8	.85	1.2	1.6	1.9	2.2	2.5	3.4	.077	.067	.067	.061
	•	9	1.0	1.3	1.8	2.2	2.5	2.8	3.8	.077	.073	.067	.061
	•	10	1.1	1.5	2.0	2.4	2.8	3.1	4.2	.079	.073	.069	.063
	•	11	1.2	1.6	2.2	2.7	3.0	3.4	4.6	.079	.073	.069	.063
	•	12	1.3	1.8	2.4	2.9	3.3	3.7	5.1	.081	.075	.071	.065
	•	13	1.4	1.9	2.6	3.1	3.6	4.0	5.5	.083	.075	.071	.067
	•	14	1.5	2.0	2.8	3.4	3.9	4.3	5.9	.083	.077	.073	.067
	•	15	1.6	2.2	3.0	3.6	4.1	4.6	6.3	.085	.079	.073	.069
	•	16	1.7	2.3	3.2	3.9	4.4	4.9	6.7	.087	.083	.075	.071
	•	17	1.8	2.5	3.4	4.1	4.7	5.2	7.2	.087	.083	.075	.071
	•	18	1.9	2.6	3.6	4.4	5.0	5.5	7.6	.089	.085	.077	.073
•	19	2.0	2.8	3.8	4.6	5.3	5.8	8.0	.089	.085	.077	.073	
•	20	2.1	2.9	4.0	4.8	5.5	6.1	8.4	.091	.087	.079	.075	
3/8 M	•	5	.53	.73	1.0	1.2	1.4	1.5	2.1	.061	.059	.047	.047
	•	6	.64	.88	1.2	1.5	1.7	1.8	2.5	.063	.063	.055	.051
	•	8	.85	1.20	1.60	1.90	2.20	2.50	3.40	.077	.067	.067	.061
	•	10	1.10	1.50	2.00	2.40	2.80	3.10	4.20	.079	.073	.069	.063
	•	13	1.40	1.90	2.60	3.10	3.60	4.00	5.50	.083	.075	.071	.067
	•	16	1.70	2.30	3.20	3.90	4.40	4.90	6.70	.087	.083	.075	.071
1/2 M	•	20	2.10	2.90	4.00	4.80	5.50	6.10	8.40	.091	.087	.079	.075
	•	20	2.12	2.92	4.00	4.80	5.50	6.10	8.40	.091	.087	.079	.075
	•	25	2.65	3.65	5.00	6.10	6.90	7.70	10.50	.099	.098	.083	.079
	•	32	3.40	4.67	6.40	7.70	8.80	9.80	13.50	.110	.102	.098	.091
3/4 M	•	40	4.25	5.84	8.00	9.70	11.10	12.30	16.90	.118	.110	.106	.098
	•	40	4.25	5.84	8.00	9.70	11.10	12.30	16.90	.118	.110	.106	.098
	•	50	5.30	7.30	10.00	12.10	13.80	15.30	21.10	.126	.114	.110	.106
•	63	6.70	9.20	12.70	15.30	17.40	19.30	26.50	.134	.122	.118	.114	

F = female threads (type IG), M = male threads (type AG)

DIMENSIONS AND WEIGHTS

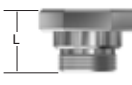
Nozzle	Nozzle Type	Inlet Conn. (in.)	L (in.)	D (in.)	Hex. (in.)
	VK-AG (M)	3/8	.787	—	3/4
		1/2	1.02	—	1
		3/4	1.10	—	1-1/4

F = female thread; M = male thread. BSPP threads.

Nozzle	Nozzle Type	Inlet Conn. (in.)	L (in.)	D (in.)	Hex. (in.)
	VK-IG (F)	3/8	1.04	.83	7/8

F = female thread; M = male thread. BSPP threads.



PERFORMANCE DATA
GANV AND GGANV FULLJET® NOZZLES

Inlet Conn. (in.)	Nozzle Type		Capacity Size	Orifice Dia. Nom. (in.)	Max. Free Passage Dia. (in.)	Flow Rate Capacity (gallons per minute)								Spray Angle (°)		
	GANV	GGANV				5 psi	7 psi	10 psi	15 psi	20 psi	40 psi	80 psi	100 psi	7 psi	20 psi	80 psi
1/4	●	●	5	.109	.078	.35	.42	.50	.61	.71	1.0	1.4	1.6	68	75	82
	●	●	7	.125	.094	.49	.59	.70	.86	.99	1.4	2.0	2.2	68	75	82
	●	●	8	.156	.109	.57	.67	.80	.98	1.1	1.6	2.3	2.5	75	80	85
	●	●	10	.156	.125	.71	.84	1.0	1.2	1.4	2.0	2.8	3.2	75	80	85
	●	●	11	.156	.141	.78	.92	1.1	1.3	1.6	2.2	3.1	3.5	75	80	85
3/8	●	●	11	.172	.125	.78	.92	1.1	1.3	1.6	2.2	3.1	3.5	75	85	83
	●	●	13	.172	.141	.92	1.1	1.3	1.6	1.8	2.6	3.7	4.1	75	85	83
	●	●	16	.172	.156	1.1	1.3	1.6	2.0	2.3	3.2	4.5	5.1	75	85	83
	●	●	20	.219	.172	1.4	1.7	2.0	2.4	2.8	4.0	5.7	6.3	75	85	83
	●	●	23	.219	.188	1.6	1.9	2.3	2.8	3.3	4.6	6.5	7.3	75	85	83
	●	●	26	.234	.203	1.8	2.2	2.6	3.2	3.7	5.2	7.4	8.2	75	85	83
	●	●	29	.234	.219	2.1	2.4	2.9	3.6	4.1	5.8	8.2	9.2	75	85	83
	●	●	33	.297	.234	2.3	2.8	3.3	4.0	4.7	6.6	9.3	10.4	75	85	83
1/2	●	●	32	.313	.203	2.3	2.7	3.2	3.9	4.5	6.4	9.1	10.1	85	90	95
	●	●	40	.313	.234	2.8	3.3	4.0	4.9	5.7	8.0	11.3	12.6	85	90	95
	●	●	48	.313	.281	3.4	4.0	4.8	5.9	6.8	9.6	13.6	15.2	85	90	95
	●	●	56	.391	.297	4.0	4.7	5.6	6.9	7.9	11.2	15.8	17.7	85	90	95
	●	●	64	.391	.328	4.5	5.4	6.4	7.8	9.1	12.8	18.1	20	85	90	95
	●	●	72	.391	.359	5.1	6.0	7.2	8.8	10.2	14.4	20	23	85	90	95

Maximum Free Passage Diameter is the maximum diameter as listed of foreign matter that can pass through the nozzle without clogging. Highlighted column shows the rated pressure.

DIMENSIONS AND WEIGHTS

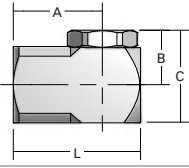
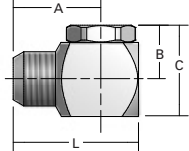
Nozzle	Nozzle Type	Inlet Conn. (in.)	L (in.)	A (in.)	B (in.)	C (in.)	Net Weight (oz.)
	GANV (F)	1/4	1.156	.781	.875	1.219	2
		3/8	1.281	.875	1.000	1.438	3.3
		1/2	1.563	1.063	1.531	2.031	6.3
	GGANV (M)	1/4	1.156	.813	.875	1.250	2
		3/8	1.313	.906	1.000	1.438	3.3
		1/2	1.625	1.125	1.531	2.031	6.3

Based on the largest/heaviest version of each type.

PERFORMANCE DATA

ENGLISH UNITS
FULL CONE NOZZLES

ENGLISH UNITS

PERFORMANCE DATA
R, RR AND RF DISTRIBOJET® NOZZLES

Inlet Conn. (in.)	Nozzle Type												Capacity Size	Flow Rate Capacity (gallons per minute)							
	R				RR				RF					1 psi	3 psi	5 psi	7 psi	10 psi	20 psi	40 psi	60 psi
	Spray Angle																				
	50°	65°	80°	95°	50°	65°	80°	95°	50°	65°	80°	95°									
2	•	•		•	•	•		•					45	27	45	57	66	78	108	148	179
		•		•		•		•					60	36	60	76	89	104	144	198	238
2-1/2	•	•		•	•	•		•					70	42	70	89	103	122	168	230	278
		•		•		•		•					90	54	90	114	133	157	215	296	357
3	•	•		•	•	•		•					110	66	110	139	162	191	263	362	436
		•		•		•		•					140	84	140	177	207	244	335	461	555
4	•	•	•		•	•	•		•	•	•		160	97	160	202	236	278	383	527	635
	•	•		•	•	•		•	•	•		•	190	115	190	240	281	331	455	625	754
		•		•		•		•		•		•	250	151	250	316	369	435	598	823	992
5	•	•	•		•	•	•		•	•	•		250	151	250	316	369	435	598	823	992
	•	•		•	•	•		•	•	•		•	280	169	280	354	413	487	670	922	1111
		•		•		•		•		•		•	380	229	380	481	561	661	909	1251	1508
6	•	•	•		•	•	•		•	•	•		360	217	360	455	532	626	862	1185	1428
	•	•		•	•	•		•	•	•		•	400	241	400	506	591	696	957	1317	1587
		•		•		•		•		•		•	560	338	560	708	827	974	1340	1844	2222
8	•	•	•		•	•	•		•	•	•		650	392	650	822	960	1131	1556	2140	2579
	•	•		•	•	•		•	•	•		•	750	452	750	949	1107	1305	1795	2469	2975
		•		•		•		•		•		•	850	513	850	1075	1255	1479	2034	2798	3372
				•				•				•	1000	603	1000	1265	1477	1740	2393	3292	3967
12												•	1400	845	1400	1771	2067	2436	3351	4609	5554
												•	1600	965	1600	2024	2363	2784	3829	5267	6347
												•	1700	1026	1700	2150	2510	2958	4069	5597	6744
												•	1800	1086	1800	2277	2658	3132	4308	5926	7141
												•	2000	1207	2000	2530	2953	3480	4787	6584	7934
												•	2200	1327	2200	2783	3249	3828	5265	7243	8728

For orifice information, contact your sales engineer.
Highlighted column shows the rated pressure.

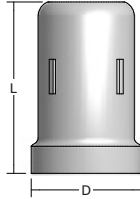
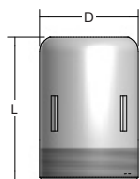
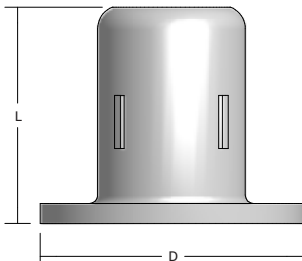

DIMENSIONS AND WEIGHTS

Nozzle	Nozzle Type	Inlet Conn. (in.)	L (in.)	D (Dia.) (in.)	Net Weight (oz.)
	R (F)	2	4.438	2.938	48
		2-1/2	5.469	3.469	88
		3	6.500	4.125	7.5 lbs.
		4	8.125	5.000	13.5 lbs.
		5	10.031	6.375	33 lbs.
		6	11.813	7.625	38.5 lbs.
		8	15.313	9.500	75 lbs.
	RR (M)	2	3.250	2.375	32
		2-1/2	4.000	2.875	84
		3	4.875	3.500	92
		4	6.500	4.500	10 lbs.
		5	8.313	5.563	25 lbs.
		6	9.750	6.625	29 lbs.
		8	13.000	8.625	56 lbs.
	RF (Flange)	4	6.563	8.875	23 lbs.
		5	8.813	9.875	39 lbs.
		6	9.813	10.875	45 lbs.
		8	13.000	13.375	85 lbs.
		12	19.500	19.000	201 lbs.

Based on the largest/heaviest version of each type.



**PERFORMANCE DATA
G-SQ, GG-SQ AND HH-SQ FULLJET® NOZZLES**

Inlet Conn. (in.)	Nozzle Type			Capacity Size	Orifice Dia. Nom. (in.)	Max. Free Passage Dia. (in.)	Flow Rate Capacity (gallons per minute)								Spray Angle (°)		
	G-SQ	GG-SQ	HH-SQ				5 psi	7 psi	10 psi	20 psi	40 psi	80 psi	100 psi	150 psi	7 psi	20 psi	80 psi
1/8	●	●	●	3.6SQ	.063	.050	.26	.31	.36	.50	.68	.94	1.0	1.3	40	52	47
	●	●	●	4.8SQ	.078	.050	.35	.41	.48	.66	.91	1.2	1.4	1.7	48	63	57
	●	●	●	6SQ	.094	.050	.44	.51	.60	.83	1.1	1.6	1.7	2.1	60	66	60
1/4	●	●	●	10SQ	.109	.063	.73	.85	1.0	1.4	1.9	2.6	2.9	3.5	62	67	61
	●	●	●	12SQ	.125	.063	.87	1.0	1.2	1.7	2.3	3.1	3.5	4.2	70	75	68
			●	14.5SQ	.154	.063	1.1	1.2	1.5	2.0	2.7	3.8	4.2	5.0	78	82	75
3/8	●	●	●	18SQ	.156	.094	1.3	1.5	1.8	2.5	3.4	4.7	5.2	6.3	71	75	68
1/2	●	●	●	29SQ	.219	.125	2.1	2.5	2.9	4.0	5.5	7.5	8.4	10.1	71	75	68
			●	36SQ	.250	.125	2.6	3.1	3.6	5.0	6.8	9.4	10.4	12.5	78	82	75
3/4			●	50SQ	.266	.172	3.6	4.2	5.0	6.9	9.5	13.0	14.4	17.4	71	75	68
1			●	106SQ	.391	.219	7.7	9.0	10.6	14.6	20	28	31	37	78	80	73

Maximum Free Passage Diameter is the maximum diameter as listed of foreign matter that can pass through the nozzle without clogging. Highlighted column shows the rated pressure.

DIMENSIONS AND WEIGHTS

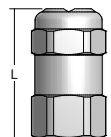
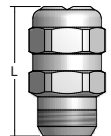
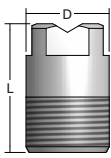
Nozzle	Nozzle Type	Inlet Conn. (in.)	L (in.)	Hex. (in.)	D (Dia.) (in.)	Net Weight (oz.)
	G-SQ (F)	1/8	1.124	9/16	—	.9
		1/4	1.342	11/16	—	1.6
	GG-SQ (M)	1/8	1.187	9/16	—	.1
		1/4	1.436	11/16	—	.1
	HH-SQ (M)	1/8	.875	—	.500	.5
		1/4	.875	—	.531	.5
		3/8	.938	—	.656	.8
		1/2	1.131	—	.813	1.7
		3/4	1.531	—	1.063	3.6
		1	2.031	—	1.313	1.4

Based on the largest/heaviest version of each type.



PERFORMANCE DATA
TG UNIJET® SPRAY TIPS

Body Inlet Conn. (in.)	Tip Type	Capacity Size	Orifice Dia. Nom. (in.)	Max. Free Passage Dia. (in.)	Flow Rate Capacity (gallons per minute)								Spray Angle (°)		
	TG				5 psi	7 psi	10 psi	20 psi	40 psi	80 psi	100 psi	150 psi	7 psi	20 psi	80 psi
1/4	●	.3	.020	.016	–	–	–	.041	.057	.078	.087	.10	–	50	61
	●	.4	.022	.018	–	–	–	.055	.076	.10	.12	.14	–	56	63
	●	.5	.024	.020	–	–	–	.069	.095	.13	.14	.17	–	56	63
	●	.6	.027	.020	–	–	–	.083	.11	.16	.17	.21	–	54	62
	●	.7	.030	.020	–	–	–	.096	.13	.18	.20	.24	–	54	63
	●	1	.036	.025	–	–	.10	.14	.19	.26	.29	.35	–	58	53
	●	2	.047	.040	.15	.17	.20	.28	.38	.52	.58	.70	43	50	46
	●	3	.062	.040	.22	.25	.30	.41	.57	.78	.87	1.0	52	65	59
	●	3.5	.067	.050	.25	.30	.35	.48	.66	.91	1.0	1.2	43	50	46
	●	5	.082	.050	.36	.42	.50	.69	.95	1.3	1.4	1.7	52	65	59
	●	6.5	.094	.063	.47	.55	.65	.89	1.2	1.7	1.9	2.3	45	50	46
●	10	.109	.063	.73	.85	1.0	1.4	1.9	2.6	2.9	3.5	58	67	61	

Maximum Free Passage Diameter is the maximum diameter as listed of foreign matter that can pass through the nozzle without clogging. Other body sizes may be available. Contact your sales engineer for further information. Highlighted column shows the rated pressure.

PERFORMANCE DATA:
TG-SQ UNIJET SPRAY TIPS

Body Inlet Conn. (in.)	Tip Type	Capacity Size	Orifice Dia. Nom. (in.)	Max. Free Passage Dia. (in.)	Flow Rate Capacity (gallons per minute)								Spray Angle (°)		
	TG-SQ				5 psi	7 psi	10 psi	20 psi	40 psi	80 psi	100 psi	150 psi	7 psi	20 psi	80 psi
1/4	●	6SQ	.094	.050	.44	.51	.60	.83	1.1	1.6	1.7	2.1	60	66	60
	●	8SQ	.099	.050	.58	.68	.80	1.1	1.5	2.1	2.3	2.8	70	75	68
	●	10SQ	.109	.063	.73	.85	1.0	1.4	1.9	2.6	2.9	3.5	62	66	60
	●	12SQ	.125	.063	.87	1.0	1.2	1.7	2.3	3.1	3.5	4.2	70	75	68
3/8	●	18SQ	.156	.094	1.3	1.5	1.8	2.5	3.4	4.7	5.2	6.3	71	75	68

Maximum Free Passage Diameter is the maximum diameter as listed of foreign matter that can pass through the nozzle without clogging. Other body sizes may be available. Contact your sales engineer for further information. Highlighted column shows the rated pressure.

DIMENSIONS AND WEIGHTS

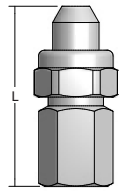
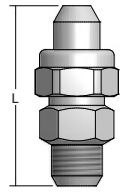
Nozzle	Nozzle Type	Inlet Conn. (in.)	L (in.)	Hex. (in.)	Net Weight (oz.)
	T (F) + TG	1/4	1.844	13/16	2.3
	TT (M) + TG	1/4	1.844	13/16	2.1

Based on the largest/heaviest version of each type. Additional sizes are available.

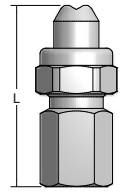
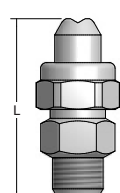
Nozzle	Nozzle Type	Inlet Conn. (in.)	L (in.)	Hex. (in.)	Net Weight (oz.)
	T (F) + TG-SQ TT (M) + TG-SQ	1/4	2.281	13/16	1.7
		3/8	2.288	13/16	2.1

Based on the largest/heaviest version of each type. Additional sizes are available.

PERFORMANCE DATA
G-VL, GG-VL AND HH-VL FULLJET® NOZZLES

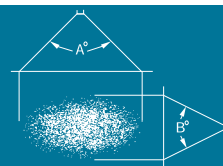

Inlet Conn. (in.)	Nozzle Type			Capacity Size	Max. Free Passage Dia. (in.)	Flow Rate Capacity (gallons per minute)							Spray Angle (°)							
						15 psi	30 psi	40 psi	60 psi	80 psi	100 psi	150 psi	15 psi		40 psi		100 psi		150 psi	
	A	B	A										B	A	B	A	B			
3/8	●	●	●	4.9VL	.040	.59	.81	.93	1.1	1.3	1.4	1.7	104	66	90	60	86	52	83	47
	●	●	●	6.5VL	.050	.78	1.1	1.2	1.5	1.7	1.9	2.3	106	64	95	60	85	50	81	45
	●	●	●	8.1VL	.050	.98	1.3	1.5	1.8	2.1	2.3	2.8	102	64	100	65	84	50	80	45
	●	●	●	9.2VL	.050	1.1	1.5	1.7	2.1	2.4	2.7	3.2	103	65	100	65	86	51	81	46

Maximum Free Passage Diameter is the maximum diameter as listed of foreign matter that can pass through the nozzle without clogging.

DIMENSIONS AND WEIGHTS

Nozzle	Nozzle Type	Inlet Conn. (in.)	L (in.)	Hex. (in.)	D (Dia.) (in.)	Net Weight (oz.)
	G-VL (F)	3/8	1.500	13/16	2.250	2.3
	GG-VL (M)	3/8	1.500	13/16	2.250	1.9
	HH-VL (M)	1/2	1.77	7/8	-	2.7

Based on the largest/heaviest version of each type.

PERFORMANCE DATA
AX AND BX WHIRLJET® NOZZLES

Inlet Conn. (in.)	Nozzle Type		Capacity Size	Inlet Dia. Nom. (in.)	Orifice Dia. Nom. (in.)	Flow Rate Capacity (gallons per minute)										Spray Angle (°)		
	AX	BX				3 psi	5 psi	10 psi	15 psi	20 psi	30 psi	40 psi	60 psi	80 psi	100 psi	10 psi	20 psi	80 psi
1/8	●	●	5	.031	.047	–	–	.05	.06	.07	.09	.10	.12	.14	.16	39	58	69
	●	●	1	.063	.063	–	–	.10	.12	.14	.17	.20	.24	.28	.32	41	64	76
	●	●	2	.078	.078	–	.14	.20	.24	.28	.35	.40	.49	.57	.63	52	61	69
	●	●	3	.094	.094	–	.21	.30	.37	.42	.52	.60	.73	.85	.95	52	64	77
	●	●	5	.125	.125	.27	.35	.50	.61	.71	.87	1.0	1.2	1.4	1.6	56	67	76
	●	●	8	.156	.156	.44	.57	.80	.98	1.1	1.4	1.6	2.0	2.3	2.5	56	65	70
	●	●	10	.172	.172	.55	.71	1.0	1.2	1.4	1.7	2.0	2.4	2.8	3.2	55	65	72
1/4	●	●	1	.063	.063	–	–	.10	.12	.14	.17	.20	.24	.28	.32	47	53	67
	●	●	2	.078	.078	–	–	.20	.24	.28	.35	.40	.49	.57	.63	56	62	71
	●	●	3	.094	.094	–	.21	.30	.37	.42	.52	.60	.73	.85	.95	51	65	78
	●	●	5	.141	.141	.27	.35	.50	.61	.71	.87	1.0	1.2	1.4	1.6	63	73	79
	●	●	8	.156	.156	.44	.57	.80	.98	1.1	1.4	1.6	2.0	2.3	2.5	61	69	73
	●	●	10	.188	.172	.55	.71	1.0	1.2	1.4	1.7	2.0	2.4	2.8	3.2	63	70	74
	●	●	15	.234	.203	.82	1.1	1.5	1.8	2.1	2.6	3.0	3.7	4.2	4.7	63	71	72
3/8	●	●	5	.140	.125	.27	.35	.50	.61	.71	.87	1.0	1.2	1.4	1.6	64	73	79
	●	●	8	.172	.156	.44	.57	.80	.98	1.1	1.4	1.6	2.0	2.3	2.5	62	70	74
	●	●	10	.203	.172	.55	.71	1.0	1.2	1.4	1.7	2.0	2.4	2.8	3.2	64	72	75
	●	●	15	.234	.219	.82	1.1	1.5	1.8	2.1	2.6	3.0	3.7	4.2	4.7	64	72	74
	●	●	20	.281	.250	1.1	1.4	2.0	2.4	2.8	3.5	4.0	4.9	5.7	6.3	63	70	74
	●	●	25	.297	.297	1.4	1.8	2.5	3.1	3.5	4.3	5.0	6.1	7.1	7.9	63	70	74
	●	●	30	.328	.313	1.6	2.1	3.0	3.7	4.2	5.2	6.0	7.3	8.5	9.5	63	70	74
1/2	●	●	25	.375	.250	1.4	1.8	2.5	3.1	3.5	4.3	5.0	6.1	7.1	7.9	63	66	71
	●	●	30	.375	.297	1.6	2.1	3.0	3.7	4.2	5.2	6.0	7.3	8.5	9.5	67	71	75
	●	●	40	.375	.359	2.2	2.8	4.0	4.9	5.7	6.9	8.0	9.8	11.3	12.6	72	76	78
	●	●	50	.375	.438	2.7	3.5	5.0	6.1	7.1	8.7	10.0	12.2	14.1	15.8	74	79	82
	●	●	60	.375	.516	3.3	4.2	6.0	7.3	8.5	10.4	12.0	14.7	17.0	19.0	77	82	86
3/4	●	●	40	.500	.297	2.2	2.8	4.0	4.9	5.7	6.9	8.0	9.8	11.3	12.6	70	73	74
	●	●	50	.500	.344	2.7	3.5	5.0	6.1	7.1	8.7	10.0	12.2	14.1	15.8	72	75	77
	●	●	60	.500	.406	3.3	4.2	6.0	7.3	8.5	10.4	12.0	14.7	17.0	19.0	74	76	79
	●	●	70	.500	.469	3.8	4.9	7.0	8.6	9.9	12.1	14.0	17.1	19.8	22	76	79	83
	●	●	80	.500	.531	4.4	5.7	8.0	9.8	11.3	13.9	16.0	19.6	23	25	78	82	84
	●	●	90	.500	.578	4.9	6.4	9.0	11.0	12.7	15.6	18.0	22	25	28	81	84	84
	●	●	100	.500	.625	5.5	7.1	10.0	12.2	14.1	17.3	20	24	28	32	83	86	86
	●	●	110	.500	.672	6.0	7.8	11.0	13.5	15.6	19.1	22	27	31	35	85	88	88
	●	●	120	.500	.719	6.6	8.5	12.0	14.7	17.0	21	24	29	34	38	87	90	90

Intermediate capacities: Caps are interchangeable for in-between capacities within each pipe size group. Request Data Sheets 3055, 3986 and 3987.
 Spray dimension data: Request Data Sheets 15350 and 15362.
 Highlighted column shows the rated pressure.



PERFORMANCE DATA

ENGLISH UNITS
HOLLOW CONE NOZZLES

ENGLISH UNITS

PERFORMANCE DATA
CX WHIRLJET® NOZZLES

Inlet Conn. (in.)	Nozzle Type CX	Capacity Size	Inlet Dia. Nom. (in.)	Orifice Dia. Nom. (in.)	Flow Rate Capacity (gallons per minute)												Spray Angle (°)		
					3 psi	4 psi	5 psi	7 psi	10 psi	15 psi	20 psi	30 psi	40 psi	60 psi	80 psi	100 psi	7 psi	20 psi	60 psi
1	●	7	.688	.453	4.6	5.3	5.9	7.0	8.4	10.2	11.8	14.5	16.7	20	24	26	64	65	66
	●	8	.688	.500	5.2	6.0	6.8	8.0	9.6	11.7	13.5	16.6	19.1	23	27	30	65	66	67
	●	9	.688	.563	5.9	6.8	7.6	9.0	10.8	13.2	15.2	18.6	22	26	30	34	66	67	69
	●	10	.688	.609	6.5	7.6	8.5	10.0	12.0	14.6	16.9	21	24	29	34	38	67	69	71
	●	12	.688	.672	7.9	9.1	10.1	12.0	14.3	17.6	20	25	29	35	41	45	70	73	75
	●	15	.688	.813	9.8	11.3	12.7	15.0	17.9	22	25	31	36	44	51	57	76	79	81
1-1/4	●	10	.844	.563	6.5	7.6	8.5	10.0	12.0	14.6	16.9	21	24	29	34	38	65	67	67
	●	12	.844	.641	7.9	9.1	10.1	12.0	14.3	17.6	20	25	29	35	41	45	68	70	71
	●	14	.844	.719	9.2	10.6	11.8	14.0	16.7	20	24	29	33	41	47	53	71	73	75
	●	16	.844	.797	10.5	12.1	13.5	16.0	19.1	23	27	33	38	47	54	60	74	75	77
	●	20	.844	.953	13.1	15.1	16.9	20	24	29	34	41	48	59	68	76	76	77	79
1-1/2	●	16	1.094	.688	10.5	12.1	13.5	16.0	19.1	23	27	33	38	47	54	60	64	67	69
	●	20	1.094	.859	13.1	15.1	16.9	20	24	29	34	41	48	59	68	76	69	72	74
	●	25	1.094	1.016	16.4	18.9	21	25	30	37	42	52	60	73	85	94	72	74	76
	●	30	1.094	1.125	19.6	23	25	30	36	44	51	62	72	88	101	113	74	76	78
2	●	30	1.438	.938	19.6	23	25	30	36	44	51	62	72	88	101	113	66	67	70
	●	35	1.438	1.063	23	26	30	35	42	51	59	72	84	102	118	132	68	70	73
	●	40	1.438	1.188	26	30	34	40	48	59	68	83	96	117	135	151	70	72	75
	●	45	1.438	1.297	29	34	38	45	54	66	76	93	108	132	152	170	72	74	78
	●	50	1.438	1.422	33	38	42	50	60	73	85	104	120	146	169	189	74	77	82
	●	60	1.438	1.563	39	45	51	60	72	88	101	124	143	176	203	227	77	79	84
2-1/2	●	60	1.875	1.422	39	45	51	60	72	88	101	124	143	176	203	227	67	68	71
	●	70	1.875	1.594	46	53	59	70	84	102	118	145	167	205	237	265	69	71	74
	●	80	1.875	1.734	52	60	68	80	96	117	135	166	191	234	270	302	71	73	77
	●	90	1.875	1.875	59	68	76	90	108	132	152	186	215	263	304	340	73	75	80
	●	100	1.875	2.000	65	76	85	100	120	146	169	207	239	293	338	378	77	79	83

Highlighted column shows the rated pressure.



**PERFORMANCE DATA
CF WHIRLJET® NOZZLES**

Inlet Conn. (in.)	Nozzle Type	Capacity Size	Inlet Dia. Nom. (in.)	Orifice Dia. Nom. (in.)	Flow Rate Capacity (gallons per minute)										Spray Angle (°)		
					3 psi	5 psi	7 psi	10 psi	20 psi	30 psi	40 psi	60 psi	80 psi	100 psi	7 psi	20 psi	60 psi
4	●	150	3.125	2.000	98	127	150	179	254	311	359	439	507	567	66	67	70
	●	175	3.125	2.328	115	148	175	209	296	362	418	512	592	661	68	70	71
	●	200	3.125	2.688	131	169	200	239	338	414	478	586	676	756	70	72	74
	●	225	3.125	2.938	147	190	225	269	380	466	538	659	761	850	72	74	77
	●	250	3.125	3.250	164	211	250	299	423	518	598	732	845	945	74	76	81
	●	275	3.125	3.625	180	232	275	329	465	569	657	805	930	1039	78	80	83
	●	150-45	3.125	2.000	98	127	150	179	254	311	359	439	507	567	45	49	52
	●	175-45	3.125	2.328	115	148	175	209	296	362	418	512	592	661	45	49	51
	●	200-45	3.125	2.688	131	169	200	239	338	414	478	586	676	756	45	48	51
	●	225-45	3.125	2.938	147	190	225	269	380	466	538	659	761	850	45	48	50
	●	250-45	3.125	3.250	164	211	250	299	423	518	598	732	845	945	45	47	49
6	●	250	4.875	2.453	164	211	250	299	423	518	598	732	845	945	65	67	69
	●	300	4.875	2.750	196	254	300	359	507	621	717	878	1014	1134	66	68	70
	●	350	4.875	3.000	229	296	350	418	592	725	837	1025	1183	1323	68	70	72
	●	400	4.875	3.250	262	338	400	478	676	828	956	1171	1352	1512	70	73	75
	●	450	4.875	3.469	295	380	450	538	761	932	1076	1317	1521	1701	72	75	77
	●	500	4.875	3.828	327	423	500	598	845	1035	1195	1464	1690	1890	74	76	79
	●	550	4.875	4.266	360	465	550	657	930	1139	1315	1610	1859	2079	76	79	83
	●	625	4.875	5.125	409	528	625	747	1056	1294	1494	1830	2113	2362	78	81	86
	●	440-65	4.875	3.469	288	372	440	526	744	911	1052	1288	1487	1663	60	61	62
	●	550-65	4.875	4.266	360	465	550	657	930	1139	1315	1610	1859	2079	64	65	66
	●	625-65	4.875	5.125	409	528	625	747	1056	1294	1494	1830	2113	2362	65	66	67

Highlighted column shows the rated pressure.

**PERFORMANCE DATA
E WHIRLJET® NOZZLES**

Inlet Conn. (in.)	Nozzle Type	Capacity Size	Inlet Dia. Nom. (in.)	Orifice Dia. Nom. (in.)	Flow Rate Capacity (gallons per minute)										Spray Angle (°)			
					3 psi	5 psi	7 psi	10 psi	15 psi	20 psi	30 psi	40 psi	60 psi	80 psi	100 psi	7 psi	20 psi	80 psi
1/4	●	2	.063	.250	—	—	—	.20	.24	.28	.35	.40	.49	.63	—	165	158	
	●	5	.094	.250	.27	.35	.42	.50	.61	.71	.87	1.0	1.2	1.4	1.6	164	154	147
	●	5.8	.109	.250	.32	.41	.49	.58	.71	.82	1.0	1.2	1.4	1.6	1.8	164	154	147
	●	8	.125	.313	.44	.57	.67	.80	.98	1.1	1.4	1.6	2.0	2.3	2.5	164	160	151
	●	10	.141	.313	.55	.71	.84	1.0	1.2	1.4	1.7	2.0	2.4	2.8	3.2	164	154	147
3/8	●	8	.109	.484	.44	.57	.67	.80	.98	1.1	1.4	1.6	2.0	2.3	2.5	164	160	157
	●	10	.125	.484	.55	.71	.84	1.0	1.2	1.4	1.7	2.0	2.4	2.8	3.2	164	160	157
	●	15	.172	.484	.82	1.1	1.3	1.5	1.8	2.1	2.6	3.0	3.7	4.2	4.7	165	163	155
	●	20	.203	.484	1.1	1.4	1.7	2.0	2.4	2.8	3.5	4.0	4.9	5.7	6.3	162	152	147
	●	25	.234	.484	1.4	1.8	2.1	2.5	3.1	3.5	4.3	5.0	6.1	7.1	7.9	162	158	154
	●	33	.266	.641	1.8	2.3	2.8	3.3	4.0	4.7	5.7	6.6	8.1	9.3	10.4	162	154	148
1/2	●	53	.375	.641	2.9	3.7	4.4	5.3	6.5	7.5	9.2	10.6	13.0	15.0	16.8	159	152	149
	●	25	.219	.641	1.4	1.8	2.1	2.5	3.1	3.5	4.3	5.0	6.1	7.1	7.9	162	158	154
	●	30	.250	.641	1.6	2.1	2.5	3.0	3.7	4.2	5.2	6.0	7.3	8.5	9.5	163	155	148
	●	40	.297	.641	2.2	2.8	3.3	4.0	4.9	5.7	6.9	8.0	9.8	11.3	12.6	160	152	144
●	53	.375	.641	2.9	3.7	4.4	5.3	6.5	7.5	9.2	10.6	13.0	15.0	16.8	159	152	149	

Highlighted column shows the rated pressure.

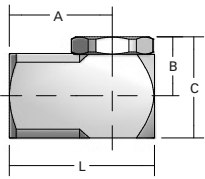
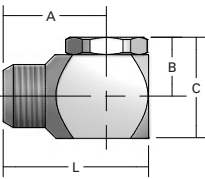
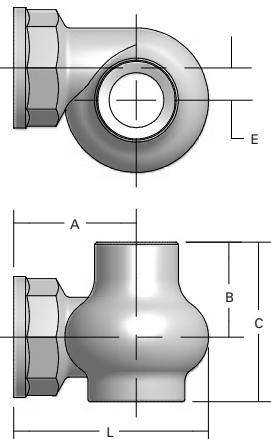
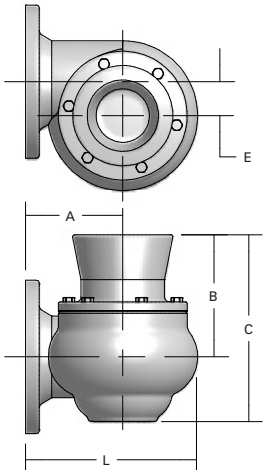

DIMENSIONS AND WEIGHTS

Nozzle	Nozzle Type	Inlet Conn. (in.)	L (in.)	A (in.)	B (in.)	C (in.)	E (in.)	Net Weight (oz.)
	AX (F)	1/8	1.000	.688	.469	.781	–	1.5
		1/4	1.250	.875	.531	.906	–	2.8
		3/8	1.469	1.031	.688	1.125	–	4.3
		1/2	1.938	1.375	.844	1.565	–	8.8
		3/4	2.188	1.375	1.563	1.250	–	11
	BX (M)	1/8	1.188	.875	.652	1.375	–	1.5
		1/4	1.375	1.000	.531	1.563	–	2.5
		3/8	1.563	1.125	.688	1.563	–	4
		1/2	1.938	1.375	.844	1.938	–	7
		3/4	2.250	1.625	1.563	1.250	–	10.8
	CX (F)	1	2.625	1.750	1.250	1.844	.348	11
		1-1/4	3.063	2.063	1.313	1.188	.438	20
		1-1/2	3.688	2.438	1.500	2.875	.563	28
		2	4.531	3.688	2.109	3.688	.719	48
		2-1/2	5.531	3.500	2.688	4.500	.469	68
	CF (Flange)	4	8.250	4.406	9.250	12.375	1.563	114 lbs.
		6	12.250	6.875	8.688	13.313	2.438	126 lbs.

Based on the largest/heaviest version of each type.

DIMENSIONS AND WEIGHTS

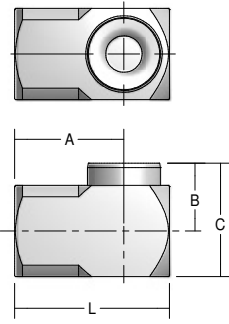
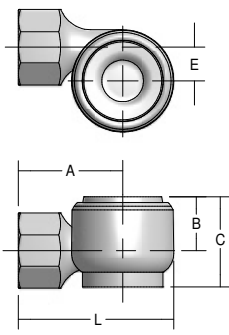
Nozzle	Nozzle Type	Inlet Conn. (in.)	L (in.)	A (in.)	B (in.)	C (in.)	E (in.)	Net Weight (oz.)
	E (F)	1/4	1.250	.875	.500	.750	–	2.3
		3/8	2.000	1.375	.625	1.250	–	10.7
		1/2	2.375	1.625	.766	1.625	–	17.3
	E (F) Cast	3/8	1.406	1.219	.594	1.063	.375	4.3
		1/2	2.188	1.438	.688	1.250	.500	6

Based on the largest/heaviest version of each type.

ENGLISH UNITS



PERFORMANCE DATA
BD WHIRLJET® NOZZLES

Inlet Conn. (in.)	Nozzle Type BD	Capacity Size	Inlet Dia. Nom. (in.)	Orifice Dia. Nom. (in.)	Flow Rate Capacity (gallons per minute)											Spray Angle (°)		
					3 psi	5 psi	7 psi	10 psi	15 psi	20 psi	30 psi	40 psi	60 psi	80 psi	100 psi	7 psi	20 psi	80 psi
3/8	●	2	.094	.078	.11	.14	.17	.20	.24	.28	.35	.40	.49	.57	.63	51	60	70
	●	3	.094	.094	.16	.21	.25	.30	.37	.42	.52	.60	.73	.85	.95	52	64	77
	●	5	.109	.125	.27	.35	.42	.50	.61	.71	.87	1.0	1.2	1.4	1.6	56	67	76
	●	8	.156	.156	.44	.57	.67	.80	.98	1.1	1.4	1.6	2.0	2.3	2.5	56	65	70
	●	10	.156	.172	.55	.71	.84	1.0	1.2	1.4	1.7	2.0	2.4	2.8	3.2	55	65	72
	●	20-10	.156*	.172	—	4.0	1.1	1.4	1.7	1.9	2.4	2.7	3.3	3.8	4.3	61	65	67
1/2	●	5	.125	.141	.27	.35	.42	.50	.61	.71	.87	1.0	1.2	1.4	1.6	63	73	79
	●	8	.156	.156	.44	.57	.67	.80	.98	1.1	1.4	1.6	2.0	2.3	2.5	61	69	73
	●	10	.172	.172	.55	.71	.84	1.0	1.2	1.4	1.7	2.0	2.4	2.8	3.2	63	70	74
	●	15	.172*	.203	.82	1.1	1.3	1.5	1.8	2.1	2.6	3.0	3.7	4.2	4.7	60	67	70
	●	20	.188*	.234	1.1	1.4	1.7	2.0	2.4	2.8	3.5	4.0	4.9	5.7	6.3	63	65	69
	●	25	.203*	.281	1.4	1.8	2.1	2.5	3.1	3.5	4.3	5.0	6.1	7.1	7.9	59	63	68
3/4	●	5	.141	.125	.27	.35	.42	.50	.61	.71	.87	1.0	1.2	1.4	1.6	64	73	79
	●	8	.172	.156	.44	.57	.67	.80	.98	1.1	1.4	1.6	2.0	2.3	2.5	62	70	74
	●	10	.203	.172	.55	.71	.84	1.0	1.2	1.4	1.7	2.0	2.4	2.8	3.2	64	72	75
	●	15	.250	.219	.82	1.1	1.3	1.5	1.8	2.1	2.6	3.0	3.7	4.2	4.7	64	72	74
	●	20	.281	.250	1.1	1.4	1.7	2.0	2.4	2.8	3.5	4.0	4.9	5.7	6.3	63	70	74
	●	25	.281	.297	1.4	1.8	2.1	2.5	3.1	3.5	4.3	5.0	6.1	7.1	7.9	63	70	74
	●	50-50.3	.281*	.375	2.7	3.5	4.2	5.0	6.0	7.0	8.5	10.0	12.2	14.1	15.8	70	72	73
1-1/2	●	40	.375*	.313	2.2	2.8	3.3	4.0	4.9	5.7	6.9	8.0	9.8	11.3	12.6	70	73	74
	●	50	.375*	.375	2.7	3.5	4.2	5.0	6.1	7.1	8.7	10.0	12.2	14.1	15.8	72	75	77
	●	60	.375*	.438	3.3	4.2	5.0	6.0	7.3	8.5	10.4	12.0	14.7	17.0	19.0	74	76	79
	●	70	.375*	.500	3.8	4.9	5.9	7.0	8.6	9.9	12.1	14.0	17.1	19.8	22	76	79	83
	●	80	.375*	.563	4.4	5.7	6.7	8.0	9.8	11.3	13.9	16.0	19.6	23	25	78	82	84
	●	90	.375*	.578	4.9	6.4	7.5	9.0	11.0	12.7	15.6	18.0	22	25	28	81	84	84
	●	100	.375*	.625	5.5	7.1	8.4	10.0	12.2	14.1	17.3	20	24	28	32	83	86	86
	●	110	.375*	.672	6.0	7.8	9.2	11.0	13.5	15.6	19.1	22	27	31	35	85	88	88
	●	120	.375*	.719	6.6	8.5	10.0	12.0	14.7	17.0	21	24	29	34	38	87	90	90

*Dual inlets, each in diameter specified.
Highlighted column shows the rated pressure.

DIMENSIONS AND WEIGHTS

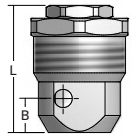
Nozzle	Nozzle Type	Inlet Conn. (in.)	L (in.)	Hex. (in.)	B (in.)	Net Weight (oz.)
	BD (M)	3/8	1.250	11/16	.266	1
		1/2	1.469	7/8	.311	2
		3/4	1.750	1-1/16	.375	4
		1-1/2	2.625	2	.311	21

Based on the largest/heaviest version of each type.



**PERFORMANCE DATA
BSJ SPIRALJET® NOZZLES**

Inlet Conn. (in.)	Nozzle Type	Spray Angle at 10 psi					Capacity Size	Orifice Dia. Nom. (in.)	Max. Free Passage Dia. (in.)	Flow Rate Capacity (gallons per minute)					
		BSJ	50°	60°	90°	120°				180°	5 psi	10 psi	20 psi	40 psi	100 psi
1/4	●	●	●	●	●	●	07	.094	.094	.49	.70	.99	1.4	2.2	4.4
	●	●	●	●	●	●	13	.125	.125	.92	1.3	1.8	2.6	4.1	8.2
	●	●	●	●	●	●	20	.156	.125	1.4	2.0	2.8	4.0	6.3	12.6
3/8	●	●	●	●	●	●	30	.188	.125	2.1	3.0	4.2	6.0	9.5	19.0
	●	●	●	●	●	●	40	.219	.125	2.8	4.0	5.7	8.0	12.6	25
	●	●	●	●	●	●	53	.250	.125	3.7	5.3	7.5	10.6	16.8	34
	●	●	●	●	●	●	82	.313	.125	5.8	8.2	11.6	16.4	26	52
1/2	●	●	●	●	●	●	120	.375	.188	8.5	12.0	17.0	24	38	76
	●	●	●	●	●	●	164	.438	.188	11.6	16.4	23	33	52	104
3/4	●	●	●	●	●	●	210	.500	.188	14.8	21	30	42	66	133
1	●		●	●	●	●	340	.625	.250	24	34	48	68	108	215
	●		●	●	●	●	470	.750	.250	33	47	66	94	149	297
1-1/2	●		●	●	●	●	640	.875	.313	45	64	91	128	202	405
	●		●	●	●	●	820	1.000	.313	58	82	116	164	259	519
	●		●	●	●	●	960	1.125	.313	68	96	136	192	304	607
2	●		●	●	●	●	1400	1.375	.438	99	140	198	280	443	885
	●		●	●	●	●	1780	1.500	.438	126	178	252	356	563	1126
3	●		●	●	●		2560	1.750	.563	181	256	362	512	810	1619
	●		●	●	●		3360	2.000	.563	238	336	475	672	1063	2125
4	●		●	●	●		5250	2.500	.625	371	525	742	1050	1660	3320

Maximum Free Passage Diameter is the maximum diameter as listed of foreign matter that can pass through the nozzle without clogging. For all 1/4" and 3/8" connections, optimum spray angle is achieved at 40 psi (2.8 bar).
 *Maximum operating pressure depends on material, size and application. Contact your local sales engineer for specific recommendations.
 Highlighted column shows the rated pressure.

DIMENSIONS AND WEIGHTS

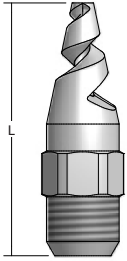
Nozzle	Nozzle Type	Inlet Conn. (in.)	L (in.)	Hex. / flats (in.)	Net Weight (oz.)
	BSJ (M)	1/4	1.875	9/16	1
		3/8	1.875	11/16	1.8
		1/2	2.500	7/8	3
		3/4	2.750	1-1/16	5
		1	3.625	1-3/8	11
		1-1/2	4.375	2	27
		2	6.875	2-1/2	48
		3	8.000	3-3/4	8 lbs.
		4	9.000	4-1/2	12.5 lbs.

Based on the largest/heaviest version of each type.



PERFORMANCE DATA

FLAT SPRAY: 50070, 50085, 56780 AND 64010 NCJ CASTERJET® NOZZLES

Capacity Code	Assembly No.				Water 7 bar (lpm)	Air 3 bar (Nm³/h)	Spray Angle
	50070	50085	64010	56780			
2	•		•	•	7.6	7.9	60° to 135°
2.5	•		•	•	9.5	9.0	
3	•				11.4	9.6	
3.5	•				13.2	15.7	
3.7	•		•	•	14.0	13.6	
4	•		•	•	15.1	15.9	
5	•				18.9	16.4	
5.7	•				21.6	20.4	
6.3	•				23.8	23.8	
6.5	•		•	•	24.6	24.9	
7			•	•	26.5	26.2	
8		•			30.3	28.9	
9		•			34.1	42.1	
10		•			37.9	38.0	
10.5		•			39.7	36.1	
12		•			45.4	36.9	

DIMENSIONS AND WEIGHTS

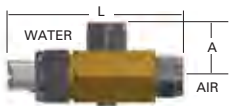
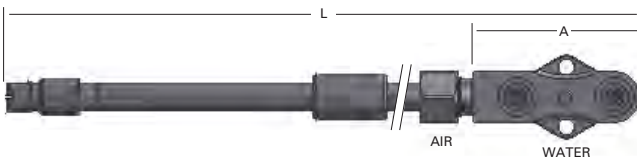
Nozzle	Nozzle Type	Air Inlet Conn. (in.)	Water Inlet Conn. (in.)	L (mm)	A (mm)
	50070	3/8 (F)	3/8 (F)	150 min.	34.6
	50085	1/2 (F)	1/2 (F)	170 min.	39.4
	64010	3/8 (F)	3/8 (F)	98	29.9
	56780	3/8 (F)	3/8 (F)	225 min.	147.3

Length varies; other sizes are available. Available with NPT or BSPT threads unless otherwise noted.



PERFORMANCE DATA
FLAT SPRAY: D40208 CASTERJET® NOZZLES

Capacity Code	Assembly No.	Water 7 bar (lpm)	Air 3 bar (Nm³/h)	Spray Angle
	D40208			
480	•	4.9	12.8	30° to 140°
490	•	5.1	8.4	
520	•	7.0	8.4	
530	•	8.4	6.6	
630	•	16.0	6.2	
640	•	14.1	6.3	
720	•	21.8	7.8	
770	•	27.5	12.0	
780	•	30.4	11.0	
850	•	39.0	11.6	

DIMENSIONS AND WEIGHTS

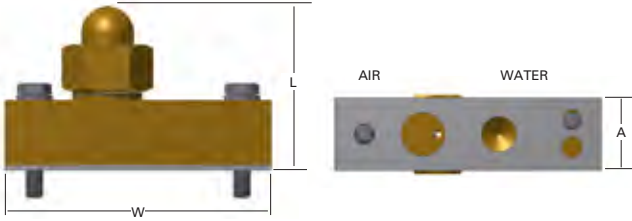
Nozzle	Nozzle Type	Air Conn. (mm)	Water Conn. (mm)	L (mm)	W (mm)	A (mm)
	D40208	12	15	53.5	91	25

PERFORMANCE DATA
FLAT SPRAY: D41968 AND D41936 ANTI-PULSING CASTERJET® NOZZLES

Capacity Code	Assembly No.		Water 7 bar (lpm)	Air 3 bar (Nm ³ /h)	Spray Angle
	D41968	D41936			
.7	•	•	3.0	1.3	40° to 120°
1.3	•		4.9	2.8	
1.7	•		6.4	1.8	
2	•	•	7.2	4.2	
2.5	•		8.8	6.5	
2.7	•		8.9	11.1	
3	•	•	11.7	5.2	
3.5	•		12.5	5.9	
4	•		14.0	8.0	
4.5	•		16.0	7.5	
5	•		18.7	9.5	
6	•		21.4	6.7	
7.5	•	•	26.0	6.2	
8	•		26.1	6.3	

DIMENSIONS AND WEIGHTS

Nozzle	Nozzle Type	Air Conn. (mm)	Water Conn. (mm)	L (mm)	A (mm)
	D41968*	8	12	1089 min.	83
	D41936*	8	12	1385	50

* Length varies.

PERFORMANCE DATA
FLAT SPRAY: 23530-XT AND 58090-XT VEEJET® NOZZLES

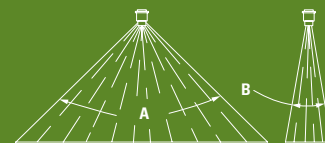

Nozzle Type	Capacity Size	Flow Rate Capacity (liters per minute)							Spray Angle at 2.8 bar	
		1 bar	2 bar	2.8 bar	4 bar	6 bar	8 bar	10 bar	A	B
23530-XT	15	3.5	4.9	5.8	6.9	8.5	9.8	11.0	105°	30°
	10	2.3	3.3	3.9	4.7	5.7	6.6	7.4	110°	30°
	20	4.7	6.6	7.8	9.3	11.4	13.2	14.7	110°	30°
58090-XT	20	4.7	6.6	7.8	9.3	11.4	13.2	14.7	45°	30°
	20	4.7	6.6	7.8	9.3	11.4	13.2	14.7	85°	30°
	26	6.0	8.5	10.1	12.1	14.8	17.1	19.1	85°	30°
	10	8.3	11.7	13.9	16.6	20.3	23.5	26.3	110°	30°
	15	3.5	4.9	5.8	6.9	8.5	9.8	11.0	110°	30°
	20	4.7	6.6	7.8	9.3	11.4	13.2	14.7	110°	30°
	26	6.0	8.5	10.1	12.1	14.8	17.1	19.1	110°	30°
	40	9.3	13.1	15.5	18.5	22.7	26.2	29.3	110°	30°

DIMENSIONS AND WEIGHTS

Nozzle	Nozzle Type	Inlet Conn. (in.)	L (mm)	Hex. (in.)	D/flats (mm)
	58090-XT (M)	1/4	25.4	9/16	15.9
		3/8	31.7	11/16	19.1

Based on the largest/heaviest version of each type.

Nozzle	Nozzle Type	Inlet Conn. (in.)	L (mm)	Hex. (in.)	D/flats (mm)
	23530-XT (M)	3/8	32.1	11/16	19.1

Based on the largest/heaviest version of each type.



PERFORMANCE DATA
FLAT SPRAY: 56862 NOZZLES

Nozzle Type	Inlet Conn. (in.)	Flow Rate Capacity (gallons per minute)							Spray Angle at 2.8 bar
		1 bar	2 bar	2.8 bar	4 bar	6 bar	8 bar	10 bar	
56862	1/2	4.7	6.6	7.8	9.3	11.4	13.2	14.8	20°

Dual heavy edge spray pattern enables each nozzle to cool two rolls.

DIMENSIONS AND WEIGHTS

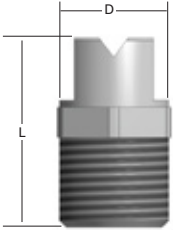
Nozzle	Nozzle Type	Inlet Conn. (in.)	L (mm)	Hex. (in.)	D/flats (mm)
	56862 (M)	1/2	38.1	7/8	15.9

Based on the largest/heaviest version of each type.

PERFORMANCE DATA
FLAT SPRAY: 49784-XT VEEJET® SPRAY TIPS

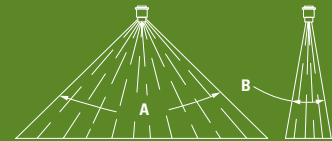

Tip Type	Capacity Size	Flow Rate Capacity (liters per minute)						Spray Angle at 2.8 bar	
		2 bar	3 bar	4 bar	5.5 bar	7 bar	10 bar	A	B
•	20	6.44	7.89	9.11	11.16	12.05	14.41	65°, 80°	30°
•	30	9.66	11.83	13.66	16.73	18.07	21.60		
•	40	12.88	15.78	18.22	22.31	24.10	28.80		
•	50	16.11	19.73	22.78	27.90	30.13	36.02		
•	120	38.61	47.66	53.68	62.12	68.97	81.01	80°	

DIMENSIONS AND WEIGHTS

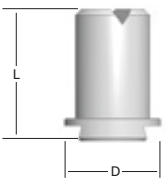
Spray Tip	Spray Tip Type	L (mm)	D (mm)
	49784-XT	38.10	17.78

Based on the largest/heaviest version of each type.

PERFORMANCE DATA
FULL CONE: 58050 AND 58160 CASTERJET® NOZZLES

Capacity Code	Assembly No.		Water 7 bar (lpm)	Air 3 bar (Nm ³ /h)	Spray Angle
	58050	58160			
075	•	•	2.6	7.5	45°, 60°, 90°
090	•	•	3.4	7.5	
095	•	•	3.6	7.7	
210	•	•	7.9	16.1	

DIMENSIONS AND WEIGHTS

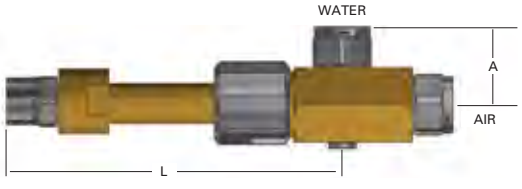
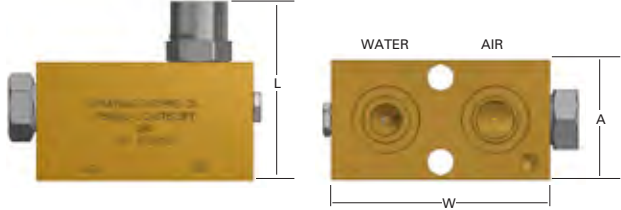
Nozzle	Nozzle Type	Air Conn. (in.)	Water Conn. (in.)	L (mm)	A (mm)	W (mm)
	58050	1/4 (F)	1/4 (F)	100 min.	28.0	–
	58160	.39	.39	74.5	40	70

PERFORMANCE DATA
FULL CONE: D40206 CASTERJET® NOZZLES

Capacity Code	Assembly No.	Water 7 bar (lpm)	Air 3 bar (Nm³/h)	Spray Angle
	D40206			
400	•	2.3	13.5	60° to 90°
440	•	2.6	14.0	
480	•	3.4	13.0	
510	•	4.5	10.8	
520	•	6.4	5.9	
530	•	7.0	6.0	
560	•	8.6	7.8	
640	•	14.4	13.0	

DIMENSIONS AND WEIGHTS

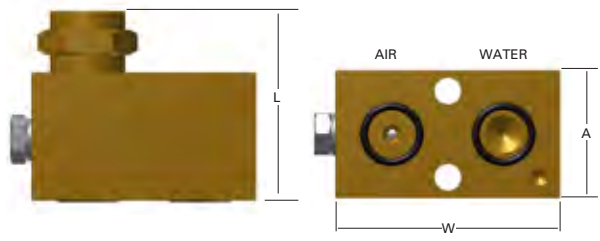
Nozzle	Nozzle Type	Air Conn. (mm)	Water Conn. (mm)	L (mm)	W (mm)	A (mm)
	D40206*	10	12	59	70	40

* Other sizes are available.

PERFORMANCE DATA
FULL CONE: HHCC FULLJET® NOZZLES

Inlet Conn. (in.)	Nozzle Type	Capacity Size	Orifice Dia. Nom. (mm)	Max. Free Passage Dia. (mm)	Flow Rate Capacity (liters per minute)										Spray Angle at 3 bar
					.7 bar	1.5 bar	2 bar	3 bar	3.5 bar	4 bar	5 bar	5.5 bar	6 bar	7 bar	
1/4	●	6.5	2.1	1.7	2.5	3.4	4.2	4.9	5.3	5.7	6.1	6.4	6.8	7.2	68°
	●	8	2.2	1.8	3.0	4.2	4.9	5.7	6.4	6.8	7.6	7.9	8.3	8.7	
	●	10	2.5	1.9	3.8	5.3	6.4	7.2	8.3	9.1	9.5	10.2	6.6	11.4	74°
	●	12.5	2.7	2.2	4.7	6.4	7.9	9.1	10.2	11	11.7	12.5	13.2	14	
3/8	●	15	3.3	2.6	5.7	7.9	9.5	11	12.1	13.2	14	15.1	15.9	16.7	
1/2	●	20	2.8	2.9	7.6	10.6	12.9	14.4	16.3	17.4	18.9	20.1	21.2	22	74°
	●	25	3.0	3.0	9.5	13.2	15.9	18.2	20.1	22	23.5	25	26.5	27.6	
	●	32	4.3	2.8	12.1	17	20.4	23.1	25.7	28	29.9	31.8	33.7	35.6	

DIMENSIONS AND WEIGHTS

Nozzle	Nozzle Type	Inlet Conn. (in.)	L (mm)	Hex. (in.)
	HHCC (M)	1/4	22.2	9/16
		3/8	23.8	11/16
		1/2	29.4	7/8

NPT or BSPT threads.
Based on the largest/heaviest version of each type.

PERFORMANCE DATA
FULL CONE: HHX FULLJET® NOZZLES

Inlet Conn. (in.)	Nozzle Type	Capacity Size	Orifice Dia. Nom. (mm)	Max. Free Passage Dia. (mm)	Flow Rate Capacity (liters per minute)										Spray Angle (°)		
					.5 bar	.7 bar	1.5 bar	2 bar	3 bar	4 bar	5 bar	6 bar	7 bar	10 bar	.5 bar	1.5 bar	6 bar
1/4	●	5	1.95	1.3	1.6	1.9	2.7	3.1	3.7	4.2	4.7	5.1	5.5	6.5	60	65	61
	●	6.5	2.4	1.6	2.1	2.5	3.5	4.0	4.8	5.5	6.1	6.7	7.1	8.4	45	50	46
	●	8	2.8	1.2	2.6	3.0	4.3	4.9	6.0	6.8	7.5	8.2	8.8	10.4	68	80	76
	●	10	2.8	1.6	3.3	3.8	5.4	6.2	7.4	8.5	9.4	10.2	11.0	13.0	58	67	61
	●	12	3.2	1.6	3.9	4.6	6.5	7.4	8.9	10.2	11.3	12.3	13.2	15.5	71	81	72
	●	14.5	3.6	1.6	4.7	5.5	7.8	9.0	10.8	12.3	13.7	14.8	15.9	18.8	78	89	75
3/8	●	15	3.6	2.4	4.9	5.7	8.1	9.3	11.2	12.7	14.1	15.4	16.5	19.4	64	67	61
	●	18	4.0	2.4	5.9	6.9	9.7	11.1	13.4	15.3	16.9	18.4	19.8	23	77	86	73
	●	20	4.4	2.8	6.5	7.6	10.8	12.4	14.9	17.0	18.8	20	22	26	76	80	73
	●	22	4.8	2.8	7.2	8.4	11.9	13.6	16.4	18.7	21	23	24	28	87	90	82

DIMENSIONS AND WEIGHTS

Nozzle	Nozzle Type	Inlet Conn. (in.)	L (mm)	Hex. (in.)
	HHX (M)	1/4	22.23	9/16
		3/8	23.83	11/16

Based on the largest/heaviest version of each type.



PERFORMANCE DATA
FULL CONE: P45075 FULLJET® NOZZLES

Inlet Conn. (in.)	Nozzle Type P45075	Capacity Size	Orifice Dia. Nom. (mm)	Max. Free Passage Dia. (mm)	Flow Rate Capacity (liters per minute)							Spray Angle at 1.4 bar
					.7 bar	1.4 bar	2 bar	2.8 bar	4 bar	5.5 bar	7 bar	
1/4	●	4	1.9	1.2	1.6	2.2	2.6	3.1	3.6	4.2	4.5	65°
	●	5.5	2.1	1.3	2.1	3.0	3.6	4.2	4.9	5.5	6.0	
	●	7.5	2.5	1.3	2.9	4.1	5.0	5.7	6.8	7.7	8.4	45°, 65°
3/8	●	3	1.5	1.0	1.0	1.5	1.8	2.1	2.3	2.7	3.0	65°
	●	3.5	1.7	1.2	1.3	1.8	2.2	2.5	3.0	3.5	3.8	
	●	4	1.8	1.2	1.6	2.2	2.6	3.1	3.6	4.2	4.5	
	●	5	2.1	1.6	1.7	2.5	3.0	3.5	4.3	4.9	5.5	
	●	5.5	2.1	1.3	2.1	3.0	3.6	4.2	4.9	5.5	6.0	
	●	7	2.4	1.3	2.7	3.6	4.6	4.9	6.1	6.8	7.6	45° or 65°
	●	8.5	2.6	1.6	3.2	4.6	5.6	6.4	7.5	8.5	9.3	65°
	●	10	2.8	1.6	3.6	5.1	6.1	7.0	8.7	9.4	10.3	45°, 65°
	●	11	2.85	1.6	4.2	5.8	6.8	7.9	9.4	10.8	12.1	
	●	14	3.5	2.4	5.4	7.6	9.1	10.2	12.5	14.0	15.5	60°
	●	22	4.2	3.0	8.2	11.4	13.2	14.9	17.4	19.5	22	60°, 90°
	●	7W	2.2	1.3	2.7	3.4	3.9	4.3	5.0	5.6	6.2	120°

DIMENSIONS AND WEIGHTS

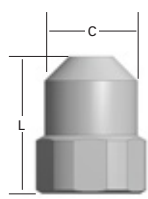
Nozzle	Nozzle Type	Inlet Conn. (in.)	L (mm)	Hex. (in.)	C (mm)	Net Weight (kg)
	P45075 (F)	1/4	28	13/16	19	.05
		3/8	26.5	7/8	21	.05

Based on the largest/heaviest version of each type.

PERFORMANCE DATA

METRIC UNITS
CONTINUOUS CASTING NOZZLES

METRIC UNITS

PERFORMANCE DATA
RECTANGULAR SPRAY: D41502 CASTERJET® NOZZLES

Capacity Code	Assembly No.	Water 7 bar (lpm)	Air 3 bar (Nm³/h)	Spray Angle
	D41502			
450	•	3.0	8.3	70° to 120°
510	•	4.6	13.5	
520	•	4.7	5.2	
540	•	7.4	8.3	
600	•	10.7	7.4	
610	•	12.1	6.4	

DIMENSIONS AND WEIGHTS

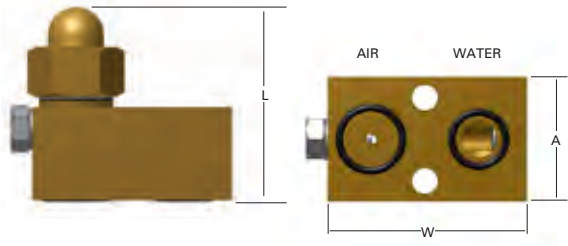
Nozzle	Nozzle Type	Air Conn. (mm)	Water Conn. (mm)	L (mm)	W (mm)	A (mm)
	D41502*	12	15	53	64	40

* Other sizes are available.

PERFORMANCE DATA
RECTANGULAR SPRAY: 25381 AND D41828 SPRAY TIPS

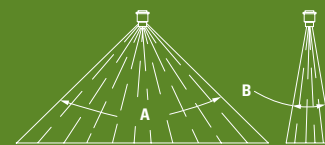

METRIC UNITS

Nozzle Type		Capacity Size	Flow Rate Capacity (liters per minute)					Spray Angle at 3 bar	
25381	D41828		2 bar	3 bar	5 bar	7 bar	14 bar	A	B
•	•	6	1.7	2.3	2.8	3.3	4.9	90° 70°	20°
•	•	8	2.2	3.0	3.7	4.5	6.1	90° 70°	20°
•	•	9	2.5	3.4	4.5	6.1	6.6	90° 70°	20°
•	•	13	3.5	4.9	6.4	7.0	9.1	90° 70° 70°	20° 30° 20°
•	•	14	4.2	5.7	6.8	7.9	11.0	90° 70° 70°	20° 30° 20°
•	•	19	5.3	6.8	9.5	10.6	14.8	90° 70°	20°
•	•	21	6.1	7.9	10.2	12.11	17.0	90° 70° 70°	20° 30° 20°
•	•	28	7.2	9.8	13.6	15.9	22.3	90° 70° 70°	20° 30° 20°
•	•	35	9.5	13.2	17.0	19.7	27.3	90° 70° 70°	20° 30° 20°
•	•	46	12.9	17.4	22.3	26.1	34.1	90° 70° 70°	20° 30° 20°
•	•	61	17.0	23.1	29.9	34.1	47.3	90° 70° 70°	20° 30° 20°
•	•	100	27.6	37.9	53.0	58.7	76.1	90° 70° 70°	20° 30° 20°

DIMENSIONS AND WEIGHTS

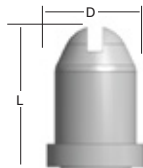
Nozzle	Nozzle Type	L (mm)	D (mm)	Net Weight (kg)
	25381	35	24	.059

Based on the largest/heaviest version of each type.

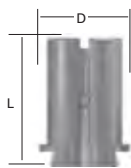
Nozzle	Nozzle Type	L (mm)	D (mm)	Net Weight (kg)
	D41828	34	20	.090

Based on the largest/heaviest version of each type.

PERFORMANCE DATA
RECTANGULAR SPRAY: D41539 SPRAY TIPS

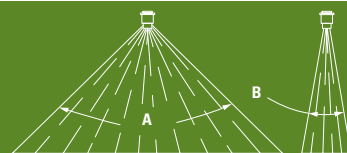

Spray Tip Type	Capacity Size	Flow Rate Capacity (liters per minute)						Spray Angle at 2.8 bar	
		1 bar	2 bar	2.8 bar	4 bar	8 bar	10 bar	A	B
D41539									
•	6	3.6	5.1	6.0	7.2	10.1	11.3	80°	24°
•	8	4.8	6.8	8.0	9.6	13.5	15.1		
•	12	7.2	10.1	12.0	14.3	20.3	22.7		
•	18	10.8	15.2	18.0	21.5	30.4	34.0		32°

DIMENSIONS AND WEIGHTS

Nozzle	Spray Tip Type	L (mm)	D1 (mm)	D2 (mm)	D3 (mm)
	D41539	52	32	38	34

PERFORMANCE DATA
IMPINGEMENT COOLING: 26010-1/4J NOZZLES

Nozzle Type	Capacity Size*	Pressure (bar)		Flow rate capacity		Spray Angle
		Air	Liquid	Air (Nm ³ /h)	Liquid (lpm)	
●	0	2.8	2.6	5.1	2.6	90°
●	1		2.3	16.5	2.3	
●	2		2.4	17.8	2.4	
●	3		4.1	10.6	4.1	
●	4		2.4	17.8	2.4	120°
●	5		4.1	9.4	10.6	

* Number of indicator rings on the air cap.

DIMENSIONS AND WEIGHTS

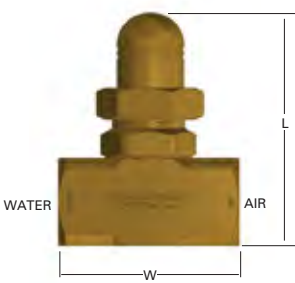
Nozzle	Nozzle Type	Air Conn. (in.)	Water Conn (in.)	L (mm)	W (mm)
	26010-1/4J	1/4	1/4	60.5	38



PERFORMANCE DATA

METRIC UNITS
DESCALING NOZZLES

METRIC UNITS

PERFORMANCE DATA
OVERVIEW

Nozzle Type								Capacity Code	Flow Rate Capacity (liters per minute)							
AA214 Compact	DescalJet® Pro	Mini DescalJet Pro	26180/26190	AA218/AA219	HiScaleJet	HSJ	Mini HiScaleJet		70 bar	100 bar	150 bar	200 bar	250 bar	300 bar	350 bar	400 bar
•								-02	3.8	4.6	5.6	6.4	7.2	7.9	8.5	9.1
•								-03	5.7	6.8	8.4	9.7	10.8	11.8	12.8	13.7
•								-04	7.6	9.1	11.2	13.0	14.5	15.9	17.2	18.4
•		•						-05	9.5	11.4	14.0	16.2	18.1	19.9	21	23
•		•					•	-06	11.4	13.7	16.8	19.5	22	24	26	28
•		•					•	-07	13.3	16.0	19.5	23	25	28	30	32
•	•	•	•	•	•	•	•	-08	15.2	18.2	22.5	26	29	32	34	37
•	•	•	•	•	•	•	•	-09	17	20.6	25.3	29	33	36	39	41
•	•	•	•	•	•	•	•	-10	18.8	23	28	32	36	40	43	46
•	•	•	•	•	•	•	•	-12	23	27	33	40.5	45	50	54	58
•	•	•	•	•	•	•	•	-15	29	34	42	49	54	60	64	69
	•	•	•	•	•	•	•	-20	38	46	56	64	72	79	85	91
	•	•	•	•	•	•	•	-25	48	57	70	81	90	99	107	114
	•	•	•	•	•	•	•	-30	57	68	84	97	108	118	128	137
	•	•	•	•	•	•	•	-35	67	80	98	113	126	138	149	160
	•	•	•	•	•	•	•	-40	77	91	112	129	144	158	171	182
	•	•	•	•	•	•	•	-50	95	114	140	161	180	197	213	228
	•	•	•	•	•	•	•	-55	105	125	154	177	198	217	235	251
	•	•	•	•	•	•	•	-60	114	137	167	193	216	237	256	274
	•	•	•	•	•	•	•	-70	134	160	195	226	252	276	299	319

DIMENSIONS AND WEIGHTS

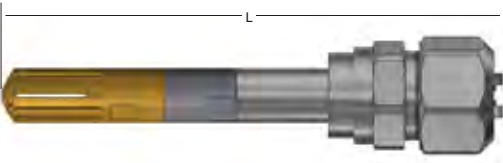
Nozzle	Nozzle Type	Inlet Conn.	L (mm)
	DescalJet® Pro Nozzles	Available with weld or 1" NPT (M) threaded connection adapters; some styles use a high impact strainer attachment, with or without body adapter for added length. Mini configuration also available. Projection into header varies by connection.	Minimum overall length: 142 Maximum length: 190 Mini DescalJet Pro nozzle length: 155 Nozzles can be ordered in any length between the minimum and maximum. Longer lengths are available upon request.

Dimensions vary depending on the capacity, configuration and options selected. Contact your local sales engineer to request dimensional data for other descaling nozzle types.

DIMENSIONS AND WEIGHTS

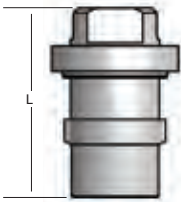
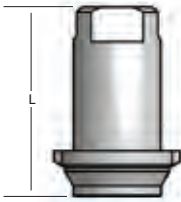
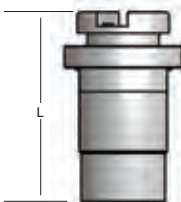
DescalJet® Pro Tip Body	Assembly No.	L (mm)	Diameter (mm)
	98016-1-_-SS	47.5	31.75
	98016-2-_-SS	47.5	28.6
	98016-3-_-SS	47.5	29.5

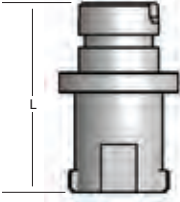
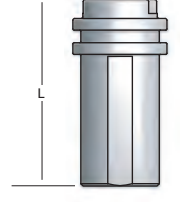
DescalJet® Pro Tip Body	Assembly No.	L (mm)	Diameter (mm)
	98016-4-_-SS	47.5	30.0
	98016-5-_-SS	47.5	24.0

For complete information, contact your local sales engineer.

METRIC UNITS

DIMENSIONS AND WEIGHTS

CVCN Check Valves	Nozzle Type	L (mm)
 CVCN check valves in varying lengths to fit existing DescalJet Pro nozzles.	DescalJet Pro with CVCN	205 to 285

For complete information, contact your local sales engineer.

PERFORMANCE DATA

METRIC UNITS
FLAT SPRAY NOZZLES

METRIC UNITS

PERFORMANCE DATA
H-VV, H-VVL AND H-DT VEEJET® NOZZLES

Spray Angle at 3 bar	Nozzle Type/ Inlet Conn. (in.)						Capacity Size	Equiv. Orifice Dia. (mm)	Flow Rate Capacity (liters per minute)										Spray Angle (°)			
	H-VV		H-VVL		H-DT				.4 bar	.7 bar	1.5 bar	3 bar	6 bar	7 bar	15 bar	20 bar	35 bar	1.5 bar	3 bar	6 bar	15 bar	
	1/8	1/4	1/8	1/4	1/8	1/4																
110°	•	•	•	•			01	.66	.14	.19	.28	.39	.56	.60	.88	1.0	1.3	94	110	121	124	
	•	•	•	•			015	.81	.22	.29	.42	.59	.84	.90	1.3	1.5	2.0	97	110	121	124	
	•	•	•	•		•	02	.89	.29	.38	.56	.79	1.1	1.2	1.8	2.0	2.7	98	110	120	123	
	•	•	•	•		•	03	1.1	.43	.57	.84	1.2	1.7	1.8	2.6	3.1	4.0	99	110	120	123	
	•	•	•	•	•	•	04	1.3	.58	.76	1.1	1.6	2.2	2.4	3.5	4.1	5.4	100	110	119	122	
	•	•	•	•		•	05	1.4	.72	.95	1.4	2.0	2.8	3.0	4.4	5.1	6.7	100	110	118	122	
	•	•	•	•	•	•	06	1.5	.86	1.1	1.7	2.4	3.4	3.6	5.3	6.1	8.1	101	110	117	122	
	•	•	•	•		•	08	1.8	1.2	1.5	2.2	3.2	4.5	4.8	7.1	8.2	10.8	102	110	117	121	
	•	•	•	•	•	•	10	2.0	1.4	1.9	2.8	3.9	5.6	6.0	8.8	10.2	13.5	103	110	117	119	
	•	•	•	•		•	15	2.4	2.2	2.9	4.2	5.9	8.4	9.0	13.2	15.3	20	104	110	117	118	
95°	•		•		•		0050	.46	–	–	.14	.20	.28	.30	.44	.51	.67	81	95	105	113	
	•	•	•	•			01	.66	.14	.19	.28	.39	.56	.60	.88	1.0	1.3	81	95	105	113	
	•		•	•			015	.81	.22	.29	.42	.59	.84	.90	1.3	1.5	2.0	82	95	105	113	
	•	•	•	•	•	•	02	.89	.29	.38	.56	.79	1.1	1.2	1.8	2.0	2.7	82	95	105	113	
	•	•	•	•		•	03	1.1	.43	.57	.84	1.2	1.7	1.8	2.6	3.1	4.0	83	95	104	111	
	•	•	•	•	•	•	04	1.3	.58	.76	1.1	1.6	2.2	2.4	3.5	4.1	5.4	84	95	103	108	
	•	•	•	•	•		05	1.4	.72	.95	1.4	2.0	2.8	3.0	4.4	5.1	6.7	84	95	102	107	
	•	•	•	•	•	•	06	1.5	.86	1.1	1.7	2.4	3.4	3.6	5.3	6.1	8.1	86	95	101	106	
	•				•		065	1.6	.94	1.2	1.8	2.6	3.6	3.9	5.7	6.6	8.8	86	95	101	106	
	•	•	•	•	•	•	08	1.8	1.2	1.5	2.2	3.2	4.5	4.8	7.1	8.2	10.8	87	95	100	105	
80°	•	•	•	•			0050	.46	–	–	.14	.20	.28	.30	.44	.51	.67	61	80	95	101	
	•	•	•	•			0067	.53	–	.13	.19	.26	.37	.40	.59	.68	.90	67	80	94	99	
	•	•	•	•	•	•	01	.66	–	.19	.28	.39	.56	.60	.88	1.0	1.3	68	80	89	92	
		•	•	•		•	015	.81	–	.29	.42	.59	.84	.90	1.3	1.5	2.0	68	80	89	92	
	•	•	•	•	•	•	02	.89	.29	.38	.56	.79	1.1	1.2	1.8	2.0	2.7	69	80	88	91	
	•	•	•	•	•	•	03	1.1	.43	.57	.84	1.2	1.7	1.8	2.6	3.1	4.0	70	80	87	90	
	•	•	•	•	•	•	04	1.3	.58	.76	1.1	1.6	2.2	2.4	3.5	4.1	5.4	71	80	86	89	
	•	•	•	•	•	•	05	1.4	.72	.95	1.4	2.0	2.8	3.0	4.4	5.1	6.7	71	80	86	89	
	•	•	•	•	•	•	06	1.5	.86	1.1	1.7	2.4	3.4	3.6	5.3	6.1	8.1	72	80	85	88	
	•				•	•	07	1.7	1.0	1.3	2.0	2.8	3.9	4.2	6.2	7.1	9.4	72	80	85	88	
	•	•	•	•	•	•	08	1.8	1.2	1.5	2.2	3.2	4.5	4.8	7.1	8.2	10.8	72	80	84	87	
		•		•	•	•	09	1.9	1.3	1.7	2.5	3.6	5.0	5.4	7.9	9.2	12.1	73	80	84	87	

Highlighted column shows the rated pressure.



**PERFORMANCE DATA
H-VV, H-VVL AND H-DT VEEJET® NOZZLES**

Spray Angle at 3 bar	Nozzle Type/ Inlet Conn. (in.)						Capacity Size	Equiv. Orifice Dia. (mm)	Flow Rate Capacity (liters per minute)									Spray Angle (°)			
	H-VV		H-VVL		H-DT				.4 bar	.7 bar	1.5 bar	3 bar	6 bar	7 bar	15 bar	20 bar	35 bar	1.5 bar	3 bar	6 bar	15 bar
	1/8	1/4	1/8	1/4	1/8	1/4															
73°	●	●	●	●	●		0077	.58	–	.15	.21	.30	.43	.46	.68	.78	1.0	53	73	86	92
	●	●	●	●			0154	.81	.22	.29	.43	.61	.86	.93	1.4	1.6	2.1	55	73	84	88
		●		●			0231	.97	.33	.44	.64	.91	1.3	1.4	2.0	2.4	3.1	56	73	83	87
	●	●	●	●			0308	1.2	.44	.59	.86	1.2	1.7	1.9	2.7	3.1	4.2	58	73	82	86
		●		●			0462	1.4	.67	.88	1.3	1.8	2.6	2.8	4.1	4.7	6.2	60	73	80	84
	●		●				0770	1.8	1.1	1.5	2.1	3.0	4.3	4.6	6.8	7.8	10.4	64	73	77	82
65°	●		●				0017	.28	–	–	.047	.067	.095	.10	.15	.17	.23	44	65	77	86
	●		●				0033	.38	–	–	.092	.13	.18	.20	.29	.34	.45	47	65	76	83
	●	●	●	●	●		0067	.53	–	.13	.19	.26	.37	.40	.59	.68	.90	50	65	75	81
	●	●	●	●	●	●	01	.66	–	.19	.28	.39	.56	.60	.88	1.0	1.3	51	65	74	80
	●	●	●	●			015	.81	–	.29	.42	.59	.84	.90	1.3	1.5	2.0	51	65	74	80
	●	●	●	●	●	●	02	.89	.29	.38	.56	.79	1.1	1.2	1.8	2.0	2.7	52	65	73	79
	●		●				025	.99	.36	.48	.70	.99	1.4	1.5	2.2	2.5	3.4	52	65	73	79
	●	●	●	●	●	●	03	1.1	.43	.57	.84	1.2	1.7	1.8	2.6	3.1	4.0	53	65	72	78
	●	●	●	●	●	●	04	1.3	.58	.76	1.1	1.6	2.2	2.4	3.5	4.1	5.4	53	65	72	76
	●	●	●	●	●	●	05	1.4	.72	.95	1.4	2.0	2.8	3.0	4.4	5.1	6.7	53	65	72	76
		●			●	●	055	1.5	.79	1.0	1.5	2.2	3.1	3.3	4.9	5.6	7.4	53	65	72	76
	●	●		●	●	●	06	1.5	.86	1.1	1.7	2.4	3.4	3.6	5.3	6.1	8.1	54	65	72	75
		●			●	●	07	1.7	1.0	1.3	2.0	2.8	3.9	4.2	6.2	7.1	9.4	54	65	71	75
	●	●	●	●	●	●	08	1.8	1.2	1.5	2.2	3.2	4.5	4.8	7.1	8.2	10.8	55	65	71	74
●				●	●	09	1.9	1.3	1.7	2.5	3.6	5.0	5.4	7.9	9.2	12.1	55	65	71	74	
50°	●	●	●	●			01	.66	–	.19	.28	.39	.56	.60	.88	1.0	1.3	37	50	59	65
	●	●	●	●			02	.89	–	.38	.56	.79	1.1	1.2	1.8	2.0	2.7	39	50	57	63
	●	●	●	●		●	03	1.1	.43	.57	.84	1.2	1.7	1.8	2.6	3.1	4.0	40	50	56	62
	●	●	●	●		●	04	1.3	.58	.76	1.1	1.6	2.2	2.4	3.5	4.1	5.4	42	50	56	61
	●	●	●	●		●	05	1.4	.72	.95	1.4	2.0	2.8	3.0	4.4	5.1	6.7	44	50	56	61
	●				●		055	1.5	.79	1.0	1.5	2.2	3.1	3.3	4.9	5.6	7.4	44	50	56	61
	●	●	●	●		●	06	1.5	.86	1.1	1.7	2.4	3.4	3.6	5.3	6.1	8.1	45	50	56	60
	●	●			●		07	1.7	1.0	1.3	2.0	2.8	3.9	4.2	6.2	7.1	9.4	45	50	56	60
	●	●	●	●		●	08	1.8	1.2	1.5	2.2	3.2	4.5	4.8	7.1	8.2	10.8	45	50	55	60
		●			●	●	09	1.9	1.3	1.7	2.5	3.6	5.0	5.4	7.9	9.2	12.1	45	50	55	59
40°	●	●	●	●	●		01	.66	–	–	.28	.39	.56	.60	.88	1.0	1.3	26	40	52	59
	●	●	●	●	●		015	.81	–	–	.42	.59	.84	.90	1.3	1.5	2.0	27	40	52	59
	●	●	●	●	●	●	02	.89	–	.38	.56	.79	1.1	1.2	1.8	2.0	2.7	29	40	51	58
	●	●	●	●	●	●	03	1.1	–	.57	.84	1.2	1.7	1.8	2.6	3.1	4.0	30	40	50	57
	●	●	●	●	●	●	04	1.3	–	.76	1.1	1.6	2.2	2.4	3.5	4.1	5.4	30	40	50	56

Highlighted column shows the rated pressure.



PERFORMANCE DATA

METRIC UNITS
FLAT SPRAY NOZZLES

METRIC UNITS

PERFORMANCE DATA
H-VV, H-VVL AND H-DT VEEJET® NOZZLES

Spray Angle at 3 bar	Nozzle Type/ Inlet Conn. (in.)						Capacity Size	Equiv. Orifice Dia. (mm)	Flow Rate Capacity (liters per minute)										Spray Angle (°)			
	H-VV		H-VVL		H-DT				.4 bar	.7 bar	1.5 bar	3 bar	6 bar	7 bar	15 bar	20 bar	35 bar	1.5 bar	3 bar	6 bar	15 bar	
	1/8	1/4	1/8	1/4	1/8	1/4																
40°	•	•	•	•	•	•	05	1.4	–	.95	1.4	2.0	2.8	3.0	4.4	5.1	6.7	31	40	49	55	
	•	•			•	•	055	1.5	–	1.0	1.5	2.2	3.1	3.3	4.9	5.6	7.4	31	40	49	55	
	•	•	•	•	•	•	06	1.5	–	1.1	1.7	2.4	3.4	3.6	5.3	6.1	8.1	31	40	49	55	
	•	•			•	•	065	1.6	–	1.2	1.8	2.6	3.6	3.9	5.7	6.6	8.8	31	40	48	54	
	•	•			•	•	07	1.7	–	1.3	2.0	2.8	3.9	4.2	6.2	7.1	9.4	31	40	48	54	
	•	•	•	•	•	•	08	1.8	1.2	1.5	2.2	3.2	4.5	4.8	7.1	8.2	10.8	31	40	47	53	
	•						085	1.8	1.2	1.6	2.4	3.4	4.7	5.1	7.5	8.7	11.5	32	40	46	50	
	•	•			•	•	09	1.9	1.3	1.7	2.5	3.6	5.0	5.4	7.9	9.2	12.1	32	40	46	50	
25°	•	•	•	•	•		01	.66	–	–	.28	.39	.56	.60	.88	1.0	1.3	14	25	34	42	
	•	•	•	•	•	•	02	.89	–	–	.56	.79	1.1	1.2	1.8	2.0	2.7	15	25	33	40	
	•	•	•	•	•	•	03	1.1	–	–	.84	1.2	1.7	1.8	2.6	3.1	4.0	15	25	33	40	
	•	•	•	•	•	•	04	1.3	–	.76	1.1	1.6	2.2	2.4	3.5	4.1	5.4	16	25	32	39	
				•	•	•	045	1.3	–	.86	1.3	1.8	2.5	2.7	4.0	4.6	6.1	16	25	32	39	
	•	•	•	•	•	•	05	1.4	–	.95	1.4	2.0	2.8	3.0	4.4	5.1	6.7	16	25	32	39	
	•	•			•	•	055	1.5	–	1.0	1.5	2.2	3.1	3.3	4.9	5.6	7.4	16	25	31	38	
	•	•	•	•	•	•	06	1.5	–	1.1	1.7	2.4	3.4	3.6	5.3	6.1	8.1	17	25	31	38	
	•	•			•	•	065	1.6	–	1.2	1.8	2.6	3.6	3.9	5.7	6.6	8.8	17	25	31	38	
	•	•	•		•	•	07	1.7	–	1.3	2.0	2.8	3.9	4.2	6.2	7.1	9.4	17	25	31	38	
	•	•					075	1.7	–	1.4	2.1	3.0	4.2	4.5	6.6	7.6	10.1	17	25	31	38	
	•	•	•	•	•	•	08	1.8	–	1.5	2.2	3.2	4.5	4.8	7.1	8.2	10.8	17	25	31	38	
	•						085	1.8	–	1.6	2.4	3.4	4.7	5.1	7.5	8.7	11.5	18	25	31	37	
	•	•			•	•	09	1.9	–	1.7	2.5	3.6	5.0	5.4	7.9	9.2	12.1	17	25	31	37	
					•		15	2.4	–	2.9	4.2	5.9	8.4	9.0	13.2	15.3	20	18	25	31	37	
15°	•	•		•			01	.66	–	–	–	.39	.56	.60	.88	1.0	1.3	–	15	24	28	
	•		•		•	•	02	.89	–	–	.56	.79	1.1	1.2	1.8	2.0	2.7	6	15	22	27	
	•	•	•	•	•	•	03	1.1	–	–	.84	1.2	1.7	1.8	2.6	3.1	4.0	6	15	22	27	
	•	•	•	•	•	•	04	1.3	–	–	1.1	1.6	2.2	2.4	3.5	4.1	5.4	7	15	21	26	
	•	•	•	•	•	•	05	1.4	–	–	1.4	2.0	2.8	3.0	4.4	5.1	6.7	7	15	21	26	
	•	•			•	•	055	1.5	–	1.0	1.5	2.2	3.1	3.3	4.9	5.6	7.4	7	15	21	26	
	•	•	•	•	•	•	06	1.5	–	1.1	1.7	2.4	3.4	3.6	5.3	6.1	8.1	8	15	21	26	
	•	•			•	•	065	1.6	–	1.2	1.8	2.6	3.6	3.9	5.7	6.6	8.8	8	15	20	25	
		•			•	•	07	1.7	–	1.3	2.0	2.8	3.9	4.2	6.2	7.1	9.4	8	15	20	25	
	•	•	•	•	•	•	08	1.8	–	1.5	2.2	3.2	4.5	4.8	7.1	8.2	10.8	9	15	20	25	
	•	•			•	•	085	1.8	–	1.6	2.4	3.4	4.7	5.1	7.5	8.7	11.5	9	15	19	24	
	•	•			•	•	09	1.9	–	1.7	2.5	3.6	5.0	5.4	7.9	9.2	12.1	9	15	19	24	

Highlighted column shows the rated pressure.



PERFORMANCE DATA
H-U, H-DU AND U VEEJET® NOZZLES

Spray Angle at 3 bar	Nozzle Type/ Inlet Conn. (in.)										Capacity Size	Equiv. Orifice Dia. (mm)	Flow Rate Capacity (liters per minute)										Spray Angle (°)			
	H-U					H-DU		U					.4 bar	.7 bar	1.5 bar	3 bar	6 bar	7 bar	15 bar	20 bar	35 bar	1.5 bar	3 bar	6 bar	15 bar	
	1/8	1/4	3/8	1/2	3/4	1/8	1/4	1	1-1/4	2																
110°		•									20	2.8	2.9	3.8	5.6	7.9	11.2	12.1	17.7	20	27	105	110	117	118	
95°	•	•		•		•	•				10	2.0	1.4	1.9	2.8	3.9	5.6	6.0	8.8	10.2	13.5	89	95	100	105	
	•	•		•		•	•				15	2.4	2.2	2.9	4.2	5.9	8.4	9.0	13.2	15.3	20	90	95	100	105	
	•	•	•				•				20	2.8	2.9	3.8	5.6	7.9	11.2	12.1	17.7	20	27	90	95	100	105	
	•	•		•		•	•				30	3.4	4.3	5.7	8.4	11.8	16.8	18.1	26	31	40	91	95	101	105	
		•	•	•			•				40	3.9	5.8	7.6	11.2	15.8	22	24	35	41	54	92	95	100	105	
		•		•			•				50	4.4	7.2	9.5	14.0	19.7	28	30	44	51	67	93	95	99	103	
		•		•			•				60	4.8	8.6	11.4	16.8	24	34	36	53	61	81	93	95	99	103	
		•	•	•			•				70	5.2	10.1	13.3	19.5	28	39	42	62	71	94	93	95	99	103	
				•							80	5.5	11.5	15.3	22	32	45	48	71	82	108	93	95	99	102	
				•							100	6.2	14.4	19.1	28	39	56	60	88	102	135	93	95	99	102	
			•							150	7.5	22	29	42	59	84	90	132	153	202	93	95	99	102		
				•						400	12.0	58	76	112	158	223	241	353	408	539	93	95	99	102		
80°	•	•	•	•		•	•				10	2.0	1.4	1.9	2.8	3.9	5.6	6.0	8.8	10.2	13.5	73	80	84	87	
	•	•		•		•	•				15	2.4	2.2	2.9	4.2	5.9	8.4	9.0	13.2	15.3	20	74	80	83	86	
	•	•	•	•		•	•				20	2.8	2.9	3.8	5.6	7.9	11.2	12.1	17.7	20	27	74	80	83	86	
	•	•	•	•		•	•				30	3.4	4.3	5.7	8.4	11.8	16.8	18.1	26	31	40	74	80	83	86	
	•	•	•	•		•	•				40	3.9	5.8	7.6	11.2	15.8	22	24	35	41	54	74	80	83	86	
		•	•	•			•				50	4.4	7.2	9.5	14.0	19.7	28	30	44	51	67	74	80	83	85	
		•	•	•			•				60	4.8	8.6	11.4	16.8	24	34	36	53	61	81	75	80	83	85	
		•	•	•			•				70	5.2	10.1	13.3	19.5	28	39	42	62	71	94	75	80	83	86	
			•	•							100	6.2	14.4	19.1	28	39	56	60	88	102	135	75	80	83	86	
			•	•							150	7.5	22	29	42	59	84	90	132	153	202	73	80	84	86	
				•	•						200	8.7	29	38	56	79	112	121	177	204	270	74	80	82	85	
				•							400	12.0	58	76	112	158	223	241	353	408	539	78	80	81	83	
									•		500	13.4	72	95	140	197	279	302	441	510	674	78	80	81	83	
								•		580	14.5	84	111	162	229	324	350	512	591	782	78	80	81	83		
65°	•	•	•			•	•				10	2.0	1.4	1.9	2.8	3.9	5.6	6.0	8.8	10.2	13.5	56	65	71	74	
	•	•									12	2.1	1.7	2.3	3.4	4.7	6.7	7.2	10.6	12.2	16.2	56	65	71	73	
	•	•	•	•		•	•				15	2.4	2.2	2.9	4.2	5.9	8.4	9.0	13.2	15.3	20	56	65	70	73	
	•	•		•		•	•				20	2.8	2.9	3.8	5.6	7.9	11.2	12.1	17.7	20	27	57	65	70	73	
	•					•	•				25	3.1	3.6	4.8	7.0	9.9	14.0	15.1	22	25	34	57	65	69	73	
	•	•	•			•	•				30	3.4	4.3	5.7	8.4	11.8	16.8	18.1	26	31	40	58	65	69	72	
	•	•	•			•	•				40	3.9	5.8	7.6	11.2	15.8	22	24	35	41	54	59	65	68	72	
	•	•	•	•			•				50	4.4	7.2	9.5	14.0	19.7	28	30	44	51	67	60	65	68	71	
		•	•	•			•				60	4.8	8.6	11.4	16.8	24	34	36	53	61	81	60	65	68	71	

Highlighted column shows the rated pressure.

METRIC UNITS



PERFORMANCE DATA

METRIC UNITS
FLAT SPRAY NOZZLES

METRIC UNITS

PERFORMANCE DATA
H-U, H-DU AND U VEEJET® NOZZLES

Spray Angle at 3 bar	Nozzle Type/ Inlet Conn. (in.)										Capacity Size	Equiv. Orifice Dia. (mm)	Flow Rate Capacity (liters per minute)										Spray Angle (°)			
	H-U					H-DU		U					.4 bar	.7 bar	1.5 bar	3 bar	6 bar	7 bar	15 bar	20 bar	35 bar	1.5 bar	3 bar	6 bar	15 bar	
	1/8	1/4	3/8	1/2	3/4	1/8	1/4	1	1-1/4	2																
65°		•	•	•			•	•				70	5.2	10.1	13.3	19.5	28	39	42	62	71	94	60	65	68	71
			•	•								100	6.2	14.4	19.1	28	39	56	60	88	102	135	58	65	69	70
			•	•								150	7.5	22	29	42	59	84	90	132	153	202	59	65	68	70
				•	•							200	8.7	29	38	56	79	112	121	177	204	270	60	65	67	69
					•							250	9.5	36	48	70	99	140	151	221	255	337	60	65	67	69
					•							300	10.4	43	57	84	118	168	181	265	306	405	60	65	67	69
					•							400	12.0	58	76	112	158	223	241	353	408	539	60	65	67	69
									•	•		500	13.4	72	95	140	197	279	302	441	510	674	60	65	66	68
50°										•		580	14.5	84	111	162	229	324	350	512	591	782	61	65	66	68
										•		02	.89	.29	.38	.56	.79	1.1	1.2	1.8	2.0	2.7	39	50	57	63
											•	03	1.1	.43	.57	.84	1.2	1.7	1.8	2.6	3.1	4.0	40	50	56	62
											•	04	1.3	.58	.76	1.1	1.6	2.2	2.4	3.5	4.1	5.4	42	50	56	61
											•	05	1.4	.72	.95	1.4	2.0	2.8	3.0	4.4	5.1	6.7	44	50	56	61
											•	055	1.5	.79	1.0	1.5	2.2	3.1	3.3	4.9	5.6	7.4	44	50	56	61
											•	06	1.5	.86	1.1	1.7	2.4	3.4	3.6	5.3	6.1	8.1	45	50	56	60
											•	07	1.7	1.0	1.3	2.0	2.8	3.9	4.2	6.2	7.1	9.4	45	50	56	60
											•	08	1.8	1.2	1.5	2.2	3.2	4.5	4.8	7.1	8.2	10.8	45	50	55	60
		•	•	•							•	10	2.0	1.4	1.9	2.8	3.9	5.6	6.0	8.8	10.2	13.5	45	50	55	59
			•	•	•						•	15	2.4	2.2	2.9	4.2	5.9	8.4	9.0	13.2	15.3	20	45	50	55	59
		•	•	•	•						•	20	2.8	2.9	3.8	5.6	7.9	11.2	12.1	17.7	20	27	45	50	55	59
		•	•	•	•						•	30	3.4	4.3	5.7	8.4	11.8	16.8	18.1	26	31	40	45	50	55	59
		•	•	•							•	40	3.9	5.8	7.6	11.2	15.8	22	24	35	41	54	46	50	54	59
		•	•	•							•	50	4.4	7.2	9.5	14.0	19.7	28	30	44	51	67	46	50	54	59
			•	•							•	60	4.8	8.6	11.4	16.8	24	34	36	53	61	81	46	50	54	59
			•	•	•						•	70	5.1	10.1	13.3	19.5	28	39	42	62	71	94	46	50	54	59
			•	•								80	5.5	11.5	15.3	22	32	45	48	71	82	108	45	50	53	58
				•								85	5.7	12.3	16.2	24	34	47	51	75	87	115	45	50	53	57
				•								90	5.8	13.0	17.2	25	36	50	54	79	92	121	45	50	53	56
			•	•							100	6.2	14.4	19.1	28	39	56	60	88	102	135	44	50	52	54	
			•								110	6.5	15.9	21	31	43	61	66	97	112	148	45	50	53	54	
			•								120	6.7	17.3	23	34	47	67	72	106	122	162	44	50	53	55	
			•								135	7.2	19.5	26	38	53	75	81	119	138	182	45	50	52	55	
			•	•							150	7.5	22	29	42	59	84	90	132	153	202	45	50	52	55	
				•							200	8.7	29	38	56	79	112	121	177	204	270	46	50	52	55	
				•							250	9.7	36	48	70	99	140	151	221	255	337	46	50	52	55	
					•						400	12.0	58	76	112	158	223	241	353	408	539	46	50	52	55	

Highlighted column shows the rated pressure.



**PERFORMANCE DATA
H-U, H-DU AND U VEEJET® NOZZLES**

Spray Angle at 3 bar	Nozzle Type/ Inlet Conn. (in.)										Capacity Size	Equiv. Orifice Dia. (mm)	Flow Rate Capacity (liters per minute)										Spray Angle (°)			
	H-U					H-DU		U					.4 bar	.7 bar	1.5 bar	3 bar	6 bar	7 bar	15 bar	20 bar	35 bar	1.5 bar	3 bar	6 bar	15 bar	
	1/8	1/4	3/8	1/2	3/4	1/8	1/4	1	1-1/4	2																
50°									●	●		500	13.4	72	95	140	197	279	302	441	510	674	49	50	51	54
									●			580	14.5	84	111	162	229	324	350	512	591	782	49	50	51	53
										●		750	16.4	108	143	209	296	419	452	662	765	1011	49	50	51	53
											●	1000	19.0	144	191	279	395	558	603	883	1019	1349	49	50	51	53
											●	1500	23.2	216	286	419	592	838	905	1324	1529	2023	49	50	51	52
											●	2000	26.8	288	381	558	790	1117	1206	1766	2039	2697	49	50	51	52
40°	●	●	●				●	●				10	2.0	1.4	1.9	2.8	3.9	5.6	6.0	8.8	10.2	13.5	32	40	45	48
	●	●	●	●			●	●				15	2.4	2.2	2.9	4.2	5.9	8.4	9.0	13.2	15.3	20	32	40	45	48
	●	●	●	●			●	●				20	2.8	2.9	3.8	5.6	7.9	11.2	12.1	17.7	20	27	32	40	45	48
	●	●	●				●	●				30	3.4	4.3	5.7	8.4	11.8	16.8	18.1	26	31	40	33	40	45	48
	●	●	●				●	●				40	3.9	5.8	7.6	11.2	15.8	22	24	35	41	54	34	40	45	48
		●	●	●				●				50	4.4	7.2	9.5	14.0	19.7	28	30	44	51	67	35	40	45	48
		●	●	●	●			●				60	4.8	8.6	11.4	16.8	24	34	36	53	61	81	35	40	45	48
		●	●	●				●				70	5.2	10.1	13.3	19.5	28	39	42	62	71	94	35	40	45	48
		●										80	5.5	11.5	15.3	22	32	45	48	71	82	108	35	40	44	47
			●	●								100	6.2	14.4	19.1	28	39	56	60	88	102	135	34	40	43	46
			●	●								150	7.5	22	29	42	59	84	90	132	153	202	35	40	43	44
				●								200	8.7	29	38	56	79	112	121	177	204	270	36	40	42	44
25°									●			500	13.4	72	95	140	197	279	302	441	510	674	38	40	41	45
	●	●					●	●				10	2.0	1.4	1.9	2.8	3.9	5.6	6.0	8.8	10.2	13.5	18	25	31	37
	●	●	●				●	●				15	2.4	2.2	2.9	4.2	5.9	8.4	9.0	13.2	15.3	20	18	25	31	37
	●	●	●				●	●				20	2.8	2.9	3.8	5.6	7.9	11.2	12.1	17.7	20	27	19	25	31	37
	●	●	●				●	●				30	3.4	4.3	5.7	8.4	11.8	16.8	18.1	26	31	40	20	25	30	36
		●	●				●	●				40	3.9	5.8	7.6	11.2	15.8	22	24	35	41	54	21	25	29	35
		●	●					●				50	4.4	7.2	9.5	14.0	19.7	28	30	44	51	67	21	25	29	35
		●	●					●				60	4.8	8.6	11.4	16.8	24	34	36	53	61	81	22	25	29	35
		●	●	●				●				70	5.2	10.1	13.3	19.5	28	39	42	62	71	94	22	25	29	35
			●	●								100	6.2	14.4	19.1	28	39	56	60	88	102	135	23	25	28	32
			●	●								150	7.5	22	29	42	59	84	90	132	153	202	24	25	28	30
				●								200	8.7	29	38	56	79	112	121	177	204	270	24	25	26	29
15°									●	●		500	13.4	72	95	140	197	279	302	441	510	674	24	25	26	29
										●		750	16.4	108	143	209	296	419	452	662	765	1011	24	25	26	28
										●		1000	19.0	144	191	279	395	558	603	883	1019	1349	24	25	26	28
	●	●	●				●	●				10	2.0	1.4	1.9	2.8	3.9	5.6	6.0	8.8	10.2	13.5	10	15	19	24
●	●	●				●	●				15	2.4	2.2	2.9	4.2	5.9	8.4	9.0	13.2	15.3	20	10	15	19	24	
●	●	●				●	●				20	2.8	2.9	3.8	5.6	7.9	11.2	12.1	17.7	20	27	10	15	19	23	

Highlighted column shows the rated pressure.

METRIC UNITS



PERFORMANCE DATA

METRIC UNITS
FLAT SPRAY NOZZLES

METRIC UNITS

PERFORMANCE DATA
H-U, H-DU AND U VEEJET® NOZZLES

Spray Angle at 3 bar	Nozzle Type/ Inlet Conn. (in.)										Capacity Size	Equiv. Orifice Dia. (mm)	Flow Rate Capacity (liters per minute)										Spray Angle (°)					
	H-U					H-DU		U					Capacity Size	Equiv. Orifice Dia. (mm)	Flow Rate Capacity (liters per minute)										Spray Angle (°)			
	1/8	1/4	3/8	1/2	3/4	1/8	1/4	1	1-1/4	2					4 bar	.7 bar	1.5 bar	3 bar	6 bar	7 bar	15 bar	20 bar	35 bar	1.5 bar	3 bar	6 bar	15 bar	
15°	•	•	•			•	•				30	3.4	4.3	5.7	8.4	11.8	16.8	18.1	26	31	40	10	15	19	21			
	•	•	•			•	•				40	3.9	5.8	7.6	11.2	15.8	22	24	35	41	54	10	15	18	21			
		•	•	•			•				50	4.4	7.2	9.5	14.0	19.7	28	30	44	51	67	11	15	18	21			
		•	•				•				60	4.8	8.6	11.4	16.8	24	34	36	53	61	81	11	15	18	21			
		•	•	•			•				70	5.2	10.1	13.3	19.5	28	39	42	62	71	94	11	15	18	21			
			•	•							100	6.2	14.4	19.1	28	39	56	60	88	102	135	13	15	17	18			
			•								120	6.7	17.3	23	34	47	67	72	106	122	162	13	15	17	18			
				•							150	7.5	22	29	42	59	84	90	132	153	202	14	15	17	18			
				•							200	8.7	29	38	56	79	112	121	177	204	270	14	15	17	18			
								•		500	13.4	72	95	140	197	279	302	441	510	674	14	15	16	17				
								•		1000	19.0	144	191	279	395	558	603	883	1019	1349	14	15	16	17				
0°	•	•					•				03	1.0	.43	.57	.84	1.2	1.7	1.8	2.6	3.1	4.0	0 Solid Stream						
	•	•				•	•				04	1.2	.58	.76	1.1	1.6	2.2	2.4	3.5	4.1	5.4							
	•	•				•	•				05	1.3	.72	.95	1.4	2.0	2.8	3.0	4.4	5.1	6.7							
	•	•				•	•				055	1.4	.79	1.0	1.5	2.2	3.1	3.3	4.9	5.6	7.4							
	•	•				•	•				06	1.5	.86	1.1	1.7	2.4	3.4	3.6	5.3	6.1	8.1							
	•	•				•	•				065	1.5	.94	1.2	1.8	2.6	3.6	3.9	5.7	6.6	8.8							
		•				•	•				07	1.6	1.0	1.3	2.0	2.8	3.9	4.2	6.2	7.1	9.4							
	•	•				•	•				08	1.7	1.2	1.5	2.2	3.2	4.5	4.8	7.1	8.2	10.8							
	•										085	1.8	1.2	1.6	2.4	3.4	4.7	5.1	7.5	8.7	11.5							
	•	•				•	•				09	1.8	1.3	1.7	2.5	3.6	5.0	5.4	7.9	9.2	12.1							
	•	•				•	•				10	1.9	1.4	1.9	2.8	3.9	5.6	6.0	8.8	10.2	13.5							
		•					•				12	2.1	1.7	2.3	3.4	4.7	6.7	7.2	10.6	12.2	16.2							
	•	•				•	•				15	2.3	2.2	2.9	4.2	5.9	8.4	9.0	13.2	15.3	20							
	•	•	•			•	•				20	2.7	2.9	3.8	5.6	7.9	11.2	12.1	17.7	20	27							
	•	•				•	•				30	3.3	4.3	5.7	8.4	11.8	16.8	18.1	26	31	40							
	•	•				•	•				40	3.8	5.8	7.6	11.2	15.8	22	24	35	41	54							
		•					•				50	4.2	7.2	9.5	14.0	19.7	28	30	44	51	67							
		•						•			60	4.6	8.6	11.4	16.8	24	34	36	53	61	81							
		•	•					•			70	5.0	10.1	13.3	19.5	28	39	42	62	71	94							
		•	•								80	5.3	11.5	15.3	22	32	45	48	71	82	108							
		•								100	6.0	14.4	19.1	28	39	56	60	88	102	135								
		•								120	6.8	17.3	23	34	47	67	72	106	122	162								
	•		•							150	7.3	22	29	42	59	84	90	132	153	202								
			•							165	7.7	24	31	46	65	92	100	146	168	223								
			•							200	8.5	29	38	56	79	112	121	177	204	270								

Highlighted column shows the rated pressure.



**PERFORMANCE DATA
H-U, H-DU AND U VEEJET® NOZZLES**

Spray Angle at 3 bar	Nozzle Type/ Inlet Conn. (in.)										Capacity Size	Equiv. Orifice Dia. (mm)	Flow Rate Capacity (liters per minute)									Spray Angle (°)			
	H-U					H-DU		U					.4 bar	.7 bar	1.5 bar	3 bar	6 bar	7 bar	15 bar	20 bar	35 bar	1.5 bar	3 bar	6 bar	15 bar
	1/8	1/4	3/8	1/2	3/4	1/8	1/4	1	1-1/4	2															
0°			●	●							250	9.5	36	48	70	99	140	151	221	255	337	0 Solid Stream			
					●						350	11.1	50	67	98	138	195	211	309	357	472				
								●	●		570	14.2	82	109	159	225	318	344	503	581	769				
					●						700	15.7	101	133	195	276	391	422	618	714	944				
								●			1000	18.8	144	191	279	395	558	603	883	1019	1349				
								●			1100	19.7	159	210	307	434	614	663	971	1121	1483				
									●		1400	22.2	202	267	391	553	782	844	1236	1427	1888				
									●		1800	25.2	259	343	503	711	1005	1086	1589	1835	2427				
										●	2000	26.5	288	381	558	790	1117	1206	1766	2039	2697				
									●	3500	35.1	505	667	977	1382	1954	2111	3090	3568	4720					

Highlighted column shows the rated pressure.

DIMENSIONS AND WEIGHTS

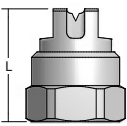
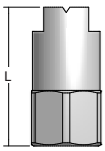
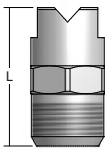
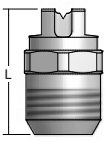
Nozzle	Nozzle Type	Inlet Conn. (in.)	L (mm)	Hex. (in.)	D (Dia.) (mm)	Net Weight (kg)
	H-DT (F)	1/8	19.1	1/2	-	.01
		1/4	19.8	5/8	-	.02
	H-DU (F)	1/8	28.6	1/2	-	.02
		1/4	28.6	5/8	-	.04
	H-U (M)	1/8	25.4	9/16	-	.01
		1/4	25.4	9/16	-	.02
		3/8	31.8	11/16	-	.04
		1/2	38.1	7/8	-	.06
		3/4	50.8	1-1/16	-	.14
	H-VV (M)	1/8	22.2	1/2	-	.01
		1/4	23.0	9/16	-	.02

Based on the largest/heaviest version of each type.

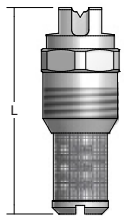
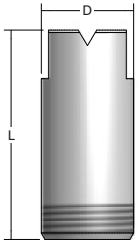
Nozzle	Nozzle Type	Inlet Conn. (in.)	L (mm)	Hex. (in.)	D (Dia.) (mm)	Net Weight (kg)
	H-VVL (M)	1/8	38.9	1/2	-	.02
		1/4	31.8	9/16	-	.03
	U (M)	1	58.8	-	33.3	.26
		1-1/4	95.3	-	42.9	.57
		2	136.5	-	60.3	1.93

Based on the largest/heaviest version of each type.

Nozzle	Nozzle Type	Inlet Conn. (in.)	L (mm)	Hex. (in.)
	58600-H3/4U with strainer	3/4	97.6	1-1/16



PERFORMANCE DATA

METRIC UNITS
FLAT SPRAY NOZZLES

METRIC UNITS

PERFORMANCE DATA
MEG AND MEG-SSTC WASHJET® NOZZLES

Nozzle Type and Spray Angle																				Capacity Size	Flow Rate Capacity (liters per minute)												
1/8 MEG					1/4 MEG					1/4 MEG-SSTC					3 bar	20 bar	35 bar	50 bar	80 bar		100 bar	140 bar	170 bar	200 bar									
0°*	5°	15°	25°	40°	50°	65°	0°*	5°	15°	25°	40°	50°	65°	0°*	5°	15°	25°	40°	50°	65°													
									•					•		•			•			01	.39	1.0	1.3	1.6	2.0	2.3	2.7	3.0	3.2		
									•													015	.59	1.5	2.0	2.4	3.1	3.4	4.0	4.5	4.8		
•	•	•	•	•			•	•	•	•	•			•	•	•		•	•			02	.79	2.0	2.7	3.2	4.1	4.6	5.4	5.9	6.4		
														•								025	.99	2.5	3.4	4.0	5.1	5.7	6.7	7.4	8.1		
•		•	•	•	•		•	•	•	•	•	•	•	•	•	•		•			•	03	1.2	3.1	4.0	4.8	6.1	6.8	8.1	8.9	9.7		
								•	•	•	•											035	1.4	3.6	4.7	5.6	7.1	8.0	9.4	10.4	11.3		
•		•	•	•	•	•	•	•	•	•	•	•	•	•	•		•	•		•	•	04	1.6	4.1	5.4	6.4	8.2	9.1	10.8	11.9	12.9		
•		•	•	•		•	•		•	•	•		•			•	•					045	1.8	4.6	6.1	7.3	9.2	10.3	12.1	13.4	14.5		
•	•	•	•	•	•	•	•	•	•	•	•	•	•	•	•		•	•	•	•		05	2.0	5.1	6.7	8.1	10.2	11.4	13.5	14.9	16.1		
•		•	•	•	•	•	•	•	•	•	•	•	•	•	•		•	•				055	2.2	5.6	7.4	8.9	11.2	12.5	14.8	16.3	17.7		
•	•	•	•	•	•	•	•	•	•	•	•	•	•	•	•		•	•	•			06	2.4	6.1	8.1	9.7	12.2	13.7	16.2	17.8	19.3		
•		•	•	•		•		•	•	•	•		•									065	2.6	6.6	8.8	10.5	13.3	14.8	17.5	19.3	21		
•	•	•	•	•	•	•	•	•	•	•	•	•	•	•	•		•	•	•	•		07	2.8	7.1	9.4	11.3	14.3	16.0	18.9	21	23		
•		•	•	•		•		•	•	•	•											075	3.0	7.6	10.1	12.1	15.3	17.1	20	22	24		
•		•	•	•	•	•	•	•	•	•	•	•	•	•	•		•	•	•		•	08	3.2	8.2	10.8	12.9	16.3	18.2	22	24	26		
•		•	•	•		•		•	•	•	•											085	3.4	8.7	11.5	13.7	17.3	19.4	23	25	27		
•		•	•	•	•	•	•	•	•	•	•	•	•	•	•		•	•	•		•	09	3.6	9.2	12.1	14.5	18.3	21	24	27	29		
		•	•			•		•		•												095	3.8	9.7	12.8	15.3	19.4	22	26	28	31		
•		•	•	•	•	•	•		•	•	•	•	•	•	•		•	•				10	3.9	10.2	13.5	16.1	20	23	27	30	32		
•			•			•		•	•	•	•											11	4.3	11.2	14.8	17.7	22	25	30	33	35		
•		•	•																			115	4.5	11.7	15.5	18.5	23	26	31	34	37		
•				•		•	•	•	•	•	•	•	•	•		•						12	4.7	12.2	16.2	19.3	24	27	32	36	39		
•						•		•	•	•	•											125	4.9	12.7	16.9	20	25	28	34	37	40		
•						•		•	•	•	•											13	5.1	13.3	17.5	21	27	30	35	39	42		
	•							•	•													14	5.5	14.3	18.9	23	29	32	38	42	45		
•		•	•			•	•	•	•	•	•	•	•	•	•		•		•		•	15	5.9	15.3	20	24	31	34	40	45	48		
		•				•		•	•													16	6.3	16.3	22	26	33	36	43	48	52		
						•		•	•	•			•									18	7.1	18.3	24	29	37	41	49	53	58		
•						•	•	•	•	•	•	•	•	•	•							20	7.9	20	27	32	41	46	54	59	64		
						•	•	•	•	•												25	9.9	25	34	40	51	57	67	74	81		
						•	•	•	•	•		•										30	11.8	31	40	48	61	68	81	89	97		
						•		•	•	•												35	13.8	36	47	56	71	80	94	104	113		
						•	•	•	•	•												40	15.8	41	54	64	82	91	108	119	129		
						•		•	•	•												50	19.7	51	67	81	102	114	135	149	161		
						•		•	•	•												60	24	61	81	97	122	137	162	178	193		
						•		•														70	28	71	94	113	143	160	189	208	226		
						•		•														80	32	82	108	129	163	182	216	238	258		
						•		•														90	36	92	121	145	183	205	243	267	290		

*0° = Solid Stream.

Highlighted column shows the rated pressure.



PERFORMANCE DATA
WEG WASHJET® NOZZLES

Nozzle Type and Spray Angle														Capacity Size	Flow Rate Capacity (liters per minute)								
1/8 WEG							1/4 WEG								3 bar	20 bar	35 bar	50 bar	80 bar	100 bar	140 bar	170 bar	200 bar
0°*	5°	15°	25°	40°	50°	65°	0°*	5°	15°	25°	40°	50°	65°										
		•	•	•										03	1.2	3.1	4.0	4.8	6.1	6.8	8.1	8.9	9.7
•		•	•	•	•	•	•		•	•	•		•	04	1.6	4.1	5.4	6.4	8.2	9.1	10.8	11.9	12.9
		•	•	•					•	•	•			045	1.8	4.6	6.1	7.3	9.2	10.3	12.1	13.4	14.5
•		•	•	•	•	•	•		•	•	•	•	•	05	2.0	5.1	6.7	8.1	10.2	11.4	13.5	14.9	16.1
•		•	•	•	•	•	•		•	•				055	2.2	5.6	7.4	8.9	11.2	12.5	14.8	16.3	17.7
•		•	•	•	•	•	•		•	•	•			06	2.4	6.1	8.1	9.7	12.2	13.7	16.2	17.8	19.3
				•					•					065	2.6	6.6	8.8	10.5	13.3	14.8	17.5	19.3	21
•		•	•	•	•	•	•		•	•	•		•	07	2.8	7.1	9.4	11.3	14.3	16.0	18.9	21	23
•		•	•	•	•	•	•		•	•	•			08	3.2	8.2	10.8	12.9	16.3	18.2	22	24	26
•		•	•	•										085	3.4	8.7	11.5	13.7	17.3	19.4	23	25	27
•		•	•	•	•	•	•		•	•	•			09	3.6	9.2	12.1	14.5	18.3	21	24	27	29
			•											095	3.8	9.7	12.8	15.3	19.4	22	26	28	31
•		•	•	•	•	•	•		•	•	•			10	3.9	10.2	13.5	16.1	20	23	27	30	32
								•						15	5.9	15.3	20	24	31	34	40	45	48
		•												16	6.3	16.3	22	26	33	36	43	48	52
•														20	7.9	20	27	32	41	46	54	59	64
								•						30	11.8	31	40	48	61	68	81	89	97

*0° = Solid Stream.

Highlighted column shows the rated pressure.

PERFORMANCE DATA
IMEG® WASHJET® NOZZLES

Inlet Conn. (in.)	Nozzle Type	Spray Angle at 3 bar								Capacity Size	Flow Rate Capacity (liters per minute)										
		IMEG®	5°	10°	15°	25°	40°	50°	65°		80°	3 bar	20 bar	35 bar	50 bar	80 bar	100 bar	140 bar	170 bar	200 bar	250 bar
1/8, 1/4	•	•	•	•	•	•	•	•	•	03	1.2	3.1	4.0	4.8	6.1	6.8	8.1	8.9	9.7	10.8	11.3
	•	•	•	•	•	•	•	•	•	035	1.4	3.6	4.7	5.6	7.1	8.0	9.4	10.4	11.3	12.6	13.2
	•	•	•	•	•	•	•	•	•	04	1.6	4.1	5.4	6.4	8.2	9.1	10.8	11.9	12.9	14.4	15.1
	•	•	•	•	•	•	•	•	•	045	1.8	4.6	6.1	7.3	9.2	10.3	12.1	13.4	14.5	16.2	17.0
	•	•	•	•	•	•	•	•	•	05	2.0	5.1	6.7	8.1	10.2	11.4	13.5	14.9	16.1	18.0	18.9
	•	•	•	•	•	•	•	•	•	055	2.2	5.6	7.4	8.9	11.2	12.5	14.8	16.3	17.7	19.8	21
	•	•	•	•	•	•	•	•	•	06	2.4	6.1	8.1	9.7	12.2	13.7	16.2	17.8	19.3	22	23
	•	•	•	•	•	•	•	•	•	065	2.6	6.6	8.8	10.5	13.3	14.8	17.5	19.3	21	23	25
	•	•	•	•	•	•	•	•	•	07	2.8	7.1	9.4	11.3	14.3	16.0	18.9	21	23	25	26
	•	•	•	•	•	•	•	•	•	075	3.0	7.6	10.1	12.1	15.3	17.1	20	22	24	27	28
•	•	•	•	•	•	•	•	•	08	3.2	8.2	10.8	12.9	16.3	18.2	22	24	26	29	30	

Highlighted column shows the rated pressure.



PERFORMANCE DATA

METRIC UNITS
FLAT SPRAY NOZZLES

METRIC UNITS

DIMENSIONS AND WEIGHTS

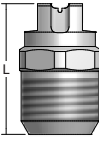
Nozzle	Nozzle Type	Inlet Conn. (in.)	L (mm)	Hex. (in.)	Flats (mm)	Net Weight (kg)
	MEG (M)	1/8	25.4	9/16	7.9	.02
		1/4	25.4	9/16	10.3	.02
	WEG (F)	1/8	28.6	1/2	7.9	.03
		1/4	28.6	5/8	7.9	.02

Based on the largest/heaviest version of each type.

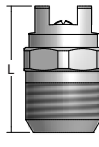
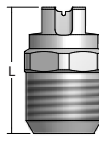
Nozzle	Nozzle Type	Inlet Conn. (in.)	L (mm)	Hex. (in.)	Flats (mm)	Net Weight (kg)
	MEG-SSTC (M)	1/4	23.0	9/16	10.3	.02
		1/8	22.2	1/2	7.9	.02
	IMEG® (M)	1/8	22.2	1/2	7.9	.02
		1/4	23.0	9/16	10.3	.02

Based on the largest/heaviest version of each type.



**PERFORMANCE DATA
K FLOODJET® NOZZLES**

Nozzle Type K	Inlet Conn. (in.)						Capacity Size	Equiv. Orifice Dia. (mm)	Flow Rate Capacity (liters per minute)								Spray Angle (°)		
	1/8	1/4	3/8	1/2	3/4	1			.2 bar	.5 bar	.7 bar	1.5 bar	2 bar	3 bar	4 bar	.5 bar	1.5 bar	4 bar	
•	•						.25	.43	–	–	–	.14	.16	.20	.23	–	83	117	
•	•						.50	.58	–	–	–	.28	.32	.39	.46	–	89	122	
•	•						.75	.74	–	–	.29	.42	.48	.59	.68	–	106	125	
•	•						1	.84	–	–	.38	.56	.64	.79	.91	–	103	128	
•	•						1.5	1.0	–	.48	.57	.84	.97	1.2	1.4	73	103	125	
•	•	•					2	1.2	–	.64	.76	1.1	1.3	1.6	1.8	83	113	129	
•	•	•					2.5	1.3	–	.81	.95	1.4	1.6	2.0	2.3	98	122	133	
•	•	•					3	1.4	–	.97	1.1	1.7	1.9	2.4	2.7	86	112	126	
•	•						4	1.7	–	1.3	1.5	2.2	2.6	3.2	3.6	97	123	132	
•	•	•					5	1.9	1.0	1.6	1.9	2.8	3.2	3.9	4.6	114	128	142	
•	•	•					7.5	2.3	1.5	2.4	2.9	4.2	4.8	5.9	6.8	101	119	134	
•	•	•					10	2.7	2.0	3.2	3.8	5.6	6.4	7.9	9.1	115	133	145	
•	•	•					12	2.9	2.4	3.9	4.6	6.7	7.7	9.5	10.9	128	139	153	
•	•	•					15	3.3	3.1	4.8	5.7	8.4	9.7	11.8	13.7	98	113	123	
•	•	•					18	3.6	3.7	5.8	6.9	10.1	11.6	14.2	16.4	106	120	131	
•	•	•					20	3.8	4.1	6.4	7.6	11.2	12.9	15.8	18.2	110	122	133	
•		•					22	3.9	4.5	7.1	8.4	12.3	14.2	17.4	20	113	125	136	
•		•					24	4.1	4.9	7.7	9.2	13.4	15.5	19.0	22	115	131	144	
•		•					27	4.4	5.5	8.7	10.3	15.1	17.4	21	25	119	135	148	
•			•				30	4.6	6.1	9.7	11.4	16.8	19.3	24	27	100	110	121	
•			•				35	5.0	7.1	11.3	13.3	19.5	23	28	32	105	118	128	
•			•	•			40	5.3	8.2	12.9	15.3	22	26	32	36	111	126	136	
•			•				45	5.6	9.2	14.5	17.2	25	29	36	41	115	130	140	
•				•			50	5.9	10.2	16.1	19.1	28	32	39	46	117	131	140	
•				•			60	6.5	12.2	19.3	23	34	39	47	55	120	134	142	
•				•			70	7.0	14.3	23	27	39	45	55	64	123	137	146	
•				•			80	7.5	16.3	26	31	45	52	63	73	127	138	149	
•					•		90	8.1	18.3	29	34	50	58	71	82	120	133	140	
•					•		100	8.5	20	32	38	56	64	79	91	123	136	145	
•					•		110	8.9	22	35	42	61	71	87	100	125	138	148	
•					•		120	9.3	24	39	46	67	77	95	109	129	143	150	
•					•		140	10.0	29	45	53	78	90	111	128	118	127	135	
•					•		160	10.7	33	52	61	89	103	126	146	121	130	137	
•					•		180	11.4	37	58	69	101	116	142	164	124	133	139	
•					•		210	12.3	43	68	80	117	135	166	191	128	139	145	
•						•	300	14.8	61	97	114	168	193	237	274	110	128	135	
•						•	450	18.0	92	145	172	251	290	355	410	118	132	138	

Highlighted column shows the rated pressure.

METRIC UNITS



PERFORMANCE DATA
TEK FLOODJET® NOZZLES

Inlet Conn. (in.)	Nozzle Type	Capacity Size	Equiv. Orifice Dia. (mm)	Flow Rate Capacity (liters per minute)							Spray Angle (°)		
				.2 bar	.5 bar	.7 bar	1.5 bar	2 bar	3 bar	4 bar	.5 bar	1.5 bar	4 bar
1/8, 1/4	●	2	1.2	–	.64	.76	1.1	1.3	1.6	1.8	85	125	134
	●	3	1.5	–	.97	1.1	1.7	1.9	2.4	2.7	85	125	136
	●	5	1.9	1.0	1.6	1.9	2.8	3.2	3.9	4.6	85	127	147
	●	10	2.7	2.0	3.2	3.8	5.6	6.4	7.9	9.1	85	130	150
1/4	●	15	3.3	3.1	4.8	5.7	8.4	9.7	11.8	13.7	90	130	138
	●	20	3.8	4.1	6.4	7.6	11.2	12.9	15.8	18.2	107	130	138

DIMENSIONS AND WEIGHTS

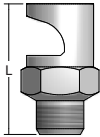
Nozzle	Nozzle Type	Inlet Conn. (in.)	L (mm)	Hex. (in.)	Net Weight (kg)
	K (M)	1/8	32.5	7/16	.01
		1/4	34.1	9/16	.03
		3/8	44.5	11/16	.06
		1/2	50.8	7/8	.11
		3/4	65.1	1-1/2	.40
		1	92.1	1-7/8	.91

Based on the largest/heaviest version of each type.

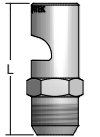
Nozzle	Nozzle Type	Inlet Conn. (in.)	L (mm)	Hex. (in.)	Net Weight (kg)
	TEK (M)	1/8	28.6	7/16	.02
		1/4	38.6	9/16	.04

Based on the largest/heaviest version of each type.

PERFORMANCE DATA
P FLATJET® NOZZLES

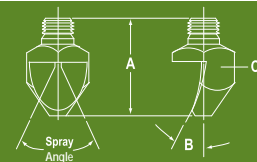

METRIC UNITS

Spray Angle at 3 bar	Nozzle Type P	Inlet Conn. (in.)					Capacity Size	Equiv. Orifice Dia. (mm)	Flow Rate Capacity (liters per minute)						Spray Angle (°)			Dimensions			
		1/8	1/4	3/8	1/2	3/4			1 bar	1.5 bar	3 bar	6 bar	7 bar	10 bar	1 bar	3 bar	7 bar	A Length (mm)	B Deflection Angle (°)	C Bar Size (mm sq.)	Net Weight (kg)
50°	●		●				05	1.3	1.1	1.4	2.0	2.8	3.0	3.6	33	50	60	31	60	15.9	.03
	●		●				10	1.9	2.3	2.8	3.9	5.6	6.0	7.2	34	50	60	31	60	15.9	.03
	●		●	●			25	3.0	5.7	7.0	9.9	14.0	15.1	18.0	42	50	59	41.5	42	19.1	.09
	●		●	●			40	3.8	9.1	11.2	15.8	22	24	29	39	50	60	47	45	19.1	.09
	●			●			60	4.6	13.7	16.8	24	34	36	43	42	50	53	55	37	25.4	.14
	●			●			100	5.9	23	28	39	56	60	72	43	50	55	72	40	31.8	.33
	●			●			125	6.6	28	35	49	70	75	90	38	50	59	72	38	31.8	.31
	●			●			160	7.5	36	45	63	89	96	115	44	50	55	72	37	31.8	.31
	●			●			200	8.4	46	56	79	112	121	144	46	50	53	72	32	31.8	.31
40°	●			●			40	3.8	9.1	11.2	15.8	22	24	29	31	40	50	60.5	35	22.2	.14
	●			●			50	4.2	11.4	14.0	19.7	28	30	36	31	40	49	63.5	33	25.4	.20
	●			●			60	4.6	13.7	16.8	24	34	36	43	32	40	49	72	33	25.4	.23
	●			●			70	5.0	16.0	19.5	28	39	42	50	32	40	49	75.5	29	25.4	.26
	●			●			80	5.3	18.2	22	32	45	48	58	32	40	48	77	26	25.4	.26
	●			●			90	5.6	21	25	36	50	54	65	34	40	44	77	28	25.4	.23
	●			●			100	5.9	23	28	39	56	60	72	35	40	44	86.5	28	25.4	.26
35°	●	●					04	1.2	.91	1.1	1.6	2.2	2.4	2.9	20	35	41	23	40	11.1	.01
	●		●				10	1.9	2.3	2.8	3.9	5.6	6.0	7.2	18	35	39	36.5	36	15.9	.06
	●		●	●			20	2.7	4.6	5.6	7.9	11.2	12.1	14.4	24	35	40	42	30	19.1	.06
	●			●			25	3.0	5.7	7.0	9.9	14.0	15.1	18.0	24	35	39	49	28	19.1	.09
	●			●			30	3.3	6.8	8.4	11.8	16.8	18.1	22	26	35	41	52.5	28	19.1	.09
	●			●			40	3.8	9.1	11.2	15.8	22	24	29	28	35	38	58	26	22.2	.11
	●			●			50	4.2	11.4	14.0	19.7	28	30	36	31	35	38	63.5	23	22.2	.14
	●				●		60	4.6	13.7	16.8	24	34	36	43	29	35	39	73	27	25.4	.23
	●				●		80	5.3	18.2	22	32	45	48	58	26	35	40	81	24	25.4	.26
	●				●		100	5.9	23	28	39	56	60	72	26	35	40	89	19	25.4	.26
	●					●	160	7.5	36	45	63	89	96	115	26	35	40	114	23	31.8	.57
	●					●	200	8.4	46	56	79	112	121	144	25	35	40	122	22	31.8	.57
25°	●		●				40	3.8	9.1	11.2	15.8	22	24	29	15	25	34	65	25	19.1	.11
15°	●		●				10	1.9	–	2.8	3.9	5.6	6.0	7.2	–	15	23	47.5	22	15.9	.06
	●		●				20	2.7	–	5.6	7.9	11.2	12.1	14.4	–	15	19	54	19	15.9	.06
	●			●			30	3.3	6.8	8.4	11.8	16.8	18.1	22	6	15	24	72	25	19.1	.11
	●			●			40	3.8	9.1	11.2	15.8	22	24	29	8	15	21	92	18	22.2	.23
	●			●			50	4.2	11.4	14.0	19.7	28	30	36	9	15	20	90.5	15	22.2	.17
	●				●		60	4.6	13.7	16.8	24	34	36	43	10	15	19	125	14	25.4	.34
	●				●		80	5.3	18.2	22	32	45	48	58	11	15	18	130	14	25.4	.34
	●				●		100	5.9	23	28	39	56	60	72	11	15	18	131	14	25.4	.40
	●					●	200	8.4	46	56	79	112	121	144	12	15	18	165	14	31.8	.73

Highlighted column shows the rated pressure.



PERFORMANCE DATA

METRIC UNITS
FLAT SPRAY NOZZLES

METRIC UNITS

PERFORMANCE DATA
TPU AND 13802 UNIJET® SPRAY TIPS

Spray Angle at 3 bar	Tip Type	Capacity Size	Equiv. Orifice Dia. (mm)	Flow Rate Capacity (liters per minute)										Spray Angle (°)			
	TPU, 13802			.4 bar	.7 bar	1.5 bar	3 bar	6 bar	7 bar	15 bar	20 bar	35 bar	1.5 bar	3 bar	6 bar	15 bar	
110°	●	0033	.38	–	–	.092	.13	.18	.20	.29	.34	.45	91	110	116	121	
	●	0050	.46	–	–	.14	.20	.28	.30	.44	.51	.67	91	110	118	124	
	●	0067	.53	–	–	.19	.26	.37	.40	.59	.68	.90	92	110	118	124	
	●	01	.66	.14	.19	.28	.39	.56	.60	.88	1.0	1.3	94	110	121	124	
	●	015	.81	.22	.29	.42	.59	.84	.90	1.3	1.5	2.0	97	110	121	124	
	●	02	.89	.29	.38	.56	.79	1.1	1.2	1.8	2.0	2.7	98	110	120	123	
	●	03	1.1	.43	.57	.84	1.2	1.7	1.8	2.6	3.1	4.0	99	110	120	123	
	●	04	1.3	.58	.76	1.1	1.6	2.2	2.4	3.5	4.1	5.4	100	110	119	122	
	●	05	1.4	.72	.95	1.4	2.0	2.8	3.0	4.4	5.1	6.7	100	110	118	122	
	●	06	1.6	.86	1.1	1.7	2.4	3.4	3.6	5.3	6.1	8.1	101	110	117	122	
	●	07	1.7	1.0	1.3	2.0	2.8	3.9	4.2	6.2	7.1	9.4	102	110	117	121	
	●	08	1.8	1.2	1.5	2.2	3.2	4.5	4.8	7.1	8.2	10.8	102	110	117	121	
	●	10	2.0	1.4	1.9	2.8	3.9	5.6	6.0	8.8	10.2	13.5	103	110	117	119	
	●	12	2.2	1.7	2.3	3.4	4.7	6.7	7.2	10.6	12.2	16.2	103	110	117	119	
	●	15	2.5	2.2	2.9	4.2	5.9	8.4	9.0	13.2	15.3	20	104	110	117	118	
●	20	2.8	2.9	3.8	5.6	7.9	11.2	12.1	17.7	20	27	105	110	117	118		
●	30	2.9	4.3	5.7	8.4	11.8	16.8	18.1	26	31	40	105	110	117	118		
95°	●	01	.66	.14	.19	.28	.39	.56	.60	.88	1.0	1.3	81	95	105	113	
	●	015	.81	.22	.29	.42	.59	.84	.90	1.3	1.5	2.0	82	95	105	113	
	●	02	.89	.29	.38	.56	.79	1.1	1.2	1.8	2.0	2.7	82	95	105	113	
	●	03	1.1	.43	.57	.84	1.2	1.7	1.8	2.6	3.1	4.0	83	95	104	111	
	●	04	1.3	.58	.76	1.1	1.6	2.2	2.4	3.5	4.1	5.4	84	95	103	108	
	●	05	1.4	.72	.95	1.4	2.0	2.8	3.0	4.4	5.1	6.7	84	95	102	107	
	●	06	1.5	.86	1.1	1.7	2.4	3.4	3.6	5.3	6.1	8.1	86	95	101	106	
	●	07	1.7	1.0	1.3	2.0	2.8	3.9	4.2	6.2	7.1	9.4	86	95	101	106	
	●	08	1.8	1.2	1.5	2.2	3.2	4.5	4.8	7.1	8.2	10.8	87	95	100	105	
	●	09	1.9	1.3	1.7	2.5	3.6	5.0	5.4	7.9	9.2	12.1	89	95	100	105	
	●	10	2.0	1.4	1.9	2.8	3.9	5.6	6.0	8.8	10.2	13.5	89	95	100	105	
	●	11	2.1	1.6	2.1	3.1	4.3	6.1	6.6	9.7	11.2	14.8	89	95	100	105	
	●	12	2.2	1.7	2.3	3.4	4.7	6.7	7.2	10.6	12.2	16.2	89	95	100	105	
	●	13	2.3	1.9	2.5	3.6	5.1	7.3	7.8	11.5	13.3	17.5	89	95	100	105	
	●	14	2.4	2.0	2.7	3.9	5.5	7.8	8.4	12.4	14.3	18.9	89	95	100	105	
	●	15	2.5	2.2	2.9	4.2	5.9	8.4	9.0	13.2	15.3	20	90	95	100	105	
	●	16	2.5	2.3	3.1	4.5	6.3	8.9	9.6	14.1	16.3	22	90	95	100	105	
	●	18	2.7	2.6	3.4	5.0	7.1	10.1	10.9	15.9	18.3	24	90	95	100	105	
	●	20	2.8	2.9	3.8	5.6	7.9	11.2	12.1	17.7	20	27	90	95	100	105	
	●	30	3.4	4.3	5.7	8.4	11.8	16.8	18.1	26	31	40	91	95	101	105	
●	40	3.9	5.8	7.6	11.2	15.8	22	24	35	41	54	92	95	100	105		
●	50	4.4	7.2	9.5	14.0	19.7	28	30	44	51	67	93	95	99	103		
●	60	4.8	8.6	11.4	16.8	24	34	36	53	61	81	93	95	99	103		
●	70	5.2	10.1	13.3	19.5	28	39	42	62	71	94	93	95	99	103		
80°	●	0050	.46	–	–	.14	.20	.28	.30	.44	.51	.67	61	80	95	101	
	●	0067	.53	–	.13	.19	.26	.37	.40	.59	.68	.90	67	80	94	99	
	●	01	.66	–	.19	.28	.39	.56	.60	.88	1.0	1.3	68	80	89	92	
	●	015	.81	–	.29	.42	.59	.84	.90	1.3	1.5	2.0	68	80	89	92	
	●	02	.89	.29	.38	.56	.79	1.1	1.2	1.8	2.0	2.7	69	80	88	91	
	●	03	1.1	.43	.57	.84	1.2	1.7	1.8	2.6	3.1	4.0	70	80	87	90	
	●	04	1.3	.58	.76	1.1	1.6	2.2	2.4	3.5	4.1	5.4	71	80	86	89	
	●	045	1.4	.65	.86	1.3	1.8	2.5	2.7	4.0	4.6	6.1	71	80	86	89	
	●	05	1.4	.72	.95	1.4	2.0	2.8	3.0	4.4	5.1	6.7	71	80	86	89	
●	06	1.6	.86	1.1	1.7	2.4	3.4	3.6	5.3	6.1	8.1	72	80	85	88		

Other body types may be available. Contact your sales engineer for further information.
Highlighted column shows the rated pressure.



**PERFORMANCE DATA
TPU AND 13802 UNIJET® SPRAY TIPS**

Spray Angle at 3 bar	Tip Type	Capacity Size	Equiv. Orifice Dia. (mm)	Flow Rate Capacity (liters per minute)									Spray Angle (°)			
	TPU, 13802			.4 bar	.7 bar	1.5 bar	3 bar	6 bar	7 bar	15 bar	20 bar	35 bar	1.5 bar	3 bar	6 bar	15 bar
80°	●	07	1.7	1.0	1.3	2.0	2.8	3.9	4.2	6.2	7.1	9.4	72	80	85	88
	●	08	1.8	1.2	1.5	2.2	3.2	4.5	4.8	7.1	8.2	10.8	72	80	84	87
	●	09	1.9	1.3	1.7	2.5	3.6	5.0	5.4	7.9	9.2	12.1	73	80	84	87
	●	10	2.0	1.4	1.9	2.8	3.9	5.6	6.0	8.8	10.2	13.5	73	80	84	87
	●	11	2.1	1.6	2.1	3.1	4.3	6.1	6.6	9.7	11.2	14.8	73	80	83	86
	●	12	2.2	1.7	2.3	3.4	4.7	6.7	7.2	10.6	12.2	16.2	73	80	83	86
	●	13	2.3	1.9	2.5	3.6	5.1	7.3	7.8	11.5	13.3	17.5	73	80	83	86
	●	14	2.4	2.0	2.7	3.9	5.5	7.8	8.4	12.4	14.3	18.9	73	80	83	86
	●	15	2.5	2.2	2.9	4.2	5.9	8.4	9.0	13.2	15.3	20	74	80	83	86
	●	16	2.5	2.3	3.1	4.5	6.3	8.9	9.6	14.1	16.3	22	74	80	83	86
	●	17	2.6	2.5	3.2	4.7	6.7	9.5	10.3	15.0	17.3	23	74	80	83	86
	●	20	2.8	2.9	3.8	5.6	7.9	11.2	12.1	17.7	20	27	74	80	83	86
	●	25	3.1	3.6	4.8	7.0	9.9	14.0	15.1	22	25	34	74	80	83	86
	●	30	3.4	4.3	5.7	8.4	11.8	16.8	18.1	26	31	40	74	80	83	86
	●	40	3.9	5.8	7.6	11.2	15.8	22	24	35	41	54	74	80	83	86
	●	50	4.4	7.2	9.5	14.0	19.7	28	30	44	51	67	74	80	83	85
	●	60	4.8	8.6	11.4	16.8	24	34	36	53	61	81	75	80	83	85
●	70	5.2	10.1	13.3	19.5	28	39	42	62	71	94	75	80	83	86	
73°	●	0023	.30	–	–	.064	.091	.13	.14	.20	.23	.31	50	73	89	97
	●	0039	.41	–	.074	.11	.15	.22	.24	.34	.40	.53	53	73	87	93
	●	0077	.58	–	.15	.21	.30	.43	.46	.68	.78	1.0	53	73	86	92
	●	0116	.71	.17	.22	.32	.46	.65	.70	1.0	1.2	1.6	54	73	85	90
	●	0154	.81	.22	.29	.43	.61	.86	.93	1.4	1.6	2.1	55	73	84	88
	●	0231	.96	.33	.44	.64	.91	1.3	1.4	2.0	2.4	3.1	56	73	83	87
	●	0308	1.1	.44	.59	.86	1.2	1.7	1.9	2.7	3.1	4.2	58	73	82	86
	●	0385	1.2	.56	.73	1.1	1.5	2.1	2.3	3.4	3.9	5.2	59	73	81	85
	●	0462	1.4	.67	.88	1.3	1.8	2.6	2.8	4.1	4.7	6.2	60	73	80	84
	●	0616	1.6	.89	1.2	1.7	2.4	3.4	3.7	5.4	6.3	8.3	63	73	79	83
	●	0770	1.8	1.1	1.5	2.1	3.0	4.3	4.6	6.8	7.8	10.4	64	73	77	82
	●	0924	1.9	1.3	1.8	2.6	3.6	5.2	5.6	8.2	9.4	12.5	65	73	77	80
	65°	●	0017	.28	–	–	.047	.067	.095	.10	.15	.17	.23	44	65	77
●		0025	.33	–	–	.070	.099	.14	.15	.22	.25	.34	45	65	77	84
●		0033	.38	–	–	.092	.13	.18	.20	.29	.34	.45	47	65	76	83
●		0050	.46	–	–	.14	.20	.28	.30	.44	.51	.67	48	65	75	82
●		0067	.53	–	.13	.19	.26	.37	.40	.59	.68	.90	50	65	75	81
●		01	.66	–	.19	.28	.39	.56	.60	.88	1.0	1.3	51	65	74	80
●		015	.81	–	.29	.42	.59	.84	.90	1.3	1.5	2.0	51	65	74	80
●		02	.89	.29	.38	.56	.79	1.1	1.2	1.8	2.0	2.7	52	65	73	79
●		025	.99	.36	.48	.70	.99	1.4	1.5	2.2	2.5	3.4	52	65	73	79
●		03	1.1	.43	.57	.84	1.2	1.7	1.8	2.6	3.1	4.0	53	65	72	78
●		035	1.2	.50	.67	.98	1.4	2.0	2.1	3.1	3.6	4.7	53	65	72	78
●		04	1.3	.58	.76	1.1	1.6	2.2	2.4	3.5	4.1	5.4	53	65	72	76

Other body types may be available. Contact your sales engineer for further information.
Highlighted column shows the rated pressure.

METRIC UNITS



PERFORMANCE DATA

METRIC UNITS
FLAT SPRAY NOZZLES

METRIC UNITS

PERFORMANCE DATA
TPU AND 13802 UNIJET® SPRAY TIPS

Spray Angle at 3 bar	Tip Type	Capacity Size	Equiv. Orifice Dia. (mm)	Flow Rate Capacity (liters per minute)										Spray Angle (°)			
	TPU, 13802			.4 bar	.7 bar	1.5 bar	3 bar	6 bar	7 bar	15 bar	20 bar	35 bar	1.5 bar	3 bar	6 bar	15 bar	
65°	●	05	1.4	.72	.95	1.4	2.0	2.8	3.0	4.4	5.1	6.7	53	65	72	76	
	●	055	1.5	.79	1.0	1.5	2.2	3.1	3.3	4.9	5.6	7.4	53	65	72	76	
	●	06	1.6	.86	1.1	1.7	2.4	3.4	3.6	5.3	6.1	8.1	54	65	72	75	
	●	07	1.7	1.0	1.3	2.0	2.8	3.9	4.2	6.2	7.1	9.4	54	65	72	75	
	●	08	1.8	1.2	1.5	2.2	3.2	4.5	4.8	7.1	8.2	10.8	55	65	71	74	
	●	09	1.9	1.3	1.7	2.5	3.6	5.0	5.4	7.9	9.2	12.1	55	65	71	74	
	●	10	2.0	1.4	1.9	2.8	3.9	5.6	6.0	8.8	10.2	13.5	56	65	71	74	
	●	11	2.1	1.6	2.1	3.1	4.3	6.1	6.6	9.7	11.2	14.8	56	65	71	74	
	●	12	2.2	1.7	2.3	3.4	4.7	6.7	7.2	10.6	12.2	16.2	56	65	71	74	
	●	13	2.3	1.9	2.5	3.6	5.1	7.3	7.8	11.5	13.3	17.5	56	65	71	74	
	●	14	2.4	2.0	2.7	3.9	5.5	7.8	8.4	12.4	14.3	18.9	56	65	71	74	
	●	15	2.5	2.2	2.9	4.2	5.9	8.4	9.0	13.2	15.3	20	56	65	70	73	
	●	20	2.8	2.9	3.8	5.6	7.9	11.2	12.1	17.7	20	27	57	65	70	73	
	●	30	3.4	4.3	5.7	8.4	11.8	16.8	18.1	26	31	40	58	65	69	72	
	●	40	3.8	5.8	7.6	11.2	15.8	22	24	35	41	54	59	65	68	72	
	●	50	4.4	7.2	9.5	14.0	19.7	28	30	44	51	67	60	65	68	71	
	●	60	4.8	8.6	11.4	16.8	24	34	36	53	61	81	60	65	68	71	
	●	70	5.2	10.1	13.3	19.5	28	39	42	62	71	94	60	65	68	71	
50°	●	0017	.28	–	–	.047	.067	.095	.10	.15	.17	.23	27	50	65	74	
	●	0025	.33	–	–	.070	.099	.14	.15	.22	.25	.34	29	50	64	71	
	●	0033	.38	–	–	.092	.13	.18	.20	.29	.34	.45	30	50	62	68	
	●	0050	.46	–	–	.14	.20	.28	.30	.44	.51	.67	32	50	60	66	
	●	0067	.53	–	–	.19	.26	.37	.40	.59	.68	.90	35	50	60	66	
	●	01	.66	–	.19	.28	.39	.56	.60	.88	1.0	1.3	37	50	59	65	
	●	015	.81	–	.29	.42	.59	.84	.90	1.3	1.5	2.0	38	50	58	64	
	●	02	.89	–	.38	.56	.79	1.1	1.2	1.8	2.0	2.7	39	50	57	63	
	●	025	.99	.36	.48	.70	.99	1.4	1.5	2.2	2.5	3.4	40	50	57	63	
	●	03	1.1	.43	.57	.84	1.2	1.7	1.8	2.6	3.1	4.0	40	50	56	62	
	●	035	1.2	.50	.67	.98	1.4	2.0	2.1	3.1	3.6	4.7	40	50	56	61	
	●	04	1.3	.58	.76	1.1	1.6	2.2	2.4	3.5	4.1	5.4	42	50	56	61	
	●	05	1.4	.72	.95	1.4	2.0	2.8	3.0	4.4	5.1	6.7	44	50	56	61	
	●	06	1.5	.86	1.1	1.7	2.4	3.4	3.6	5.3	6.1	8.1	45	50	56	60	
	●	07	1.7	1.0	1.3	2.0	2.8	3.9	4.2	6.2	7.1	9.4	45	50	56	60	
	●	075	1.7	1.1	1.4	2.1	3.0	4.2	4.5	6.6	7.6	10.1	45	50	55	60	
	●	08	1.8	1.2	1.5	2.2	3.2	4.5	4.8	7.1	8.2	10.8	45	50	55	60	
	●	09	1.9	1.3	1.7	2.5	3.6	5.0	5.4	7.9	9.2	12.1	45	50	55	59	
	●	10	2.0	1.4	1.9	2.8	3.9	5.6	6.0	8.8	10.2	13.5	45	50	55	59	
	●	13	2.3	1.9	2.5	3.6	5.1	7.3	7.8	11.5	13.3	17.5	45	50	55	59	
●	15	2.5	2.2	2.9	4.2	5.9	8.4	9.0	13.2	15.3	20	45	50	55	59		
●	20	2.8	2.9	3.8	5.6	7.9	11.2	12.1	17.7	20	27	45	50	55	59		
●	30	3.4	4.3	5.7	8.4	11.8	16.8	18.1	26	31	40	45	50	55	59		
●	40	3.8	5.8	7.6	11.2	15.8	22	24	35	41	54	46	50	54	59		

Other body types may be available. Contact your sales engineer for further information.
Highlighted column shows the rated pressure.



**PERFORMANCE DATA
TPU AND 13802 UNIJET® SPRAY TIPS**

Spray Angle at 3 bar	Tip Type	Capacity Size	Equiv. Orifice Dia. (mm)	Flow Rate Capacity (liters per minute)									Spray Angle (°)			
	TPU, 13802			.4 bar	.7 bar	1.5 bar	3 bar	6 bar	7 bar	15 bar	20 bar	35 bar	1.5 bar	3 bar	6 bar	15 bar
50°	●	50	4.4	7.2	9.5	14.0	19.7	28	30	44	51	67	46	50	54	59
	●	60	4.8	8.6	11.4	16.8	24	34	36	53	61	81	46	50	54	59
	●	70	5.2	10.1	13.3	19.5	28	39	42	62	71	94	46	50	54	59
40°	●	0017	.28	–	–	.047	.067	.095	.10	.15	.17	.23	21	40	54	61
	●	0025	.33	–	–	.070	.099	.14	.15	.22	.25	.34	22	40	53	60
	●	0033	.38	–	–	.092	.13	.18	.20	.29	.34	.45	22	40	53	60
	●	0050	.46	–	–	.14	.20	.28	.30	.44	.51	.67	22	40	53	60
	●	0067	.53	–	–	.19	.26	.37	.40	.59	.68	.90	24	40	53	60
	●	01	.66	–	–	.28	.39	.56	.60	.88	1.0	1.3	26	40	52	59
	●	015	.81	–	–	.42	.59	.84	.90	1.3	1.5	2.0	27	40	52	59
	●	02	.89	–	.38	.56	.79	1.1	1.2	1.8	2.0	2.7	29	40	51	58
	●	025	.99	–	.48	.70	.99	1.4	1.5	2.2	2.5	3.4	29	40	51	58
	●	03	1.1	–	.57	.84	1.2	1.7	1.8	2.6	3.1	4.0	30	40	50	57
	●	04	1.3	–	.76	1.1	1.6	2.2	2.4	3.5	4.1	5.4	30	40	50	56
	●	05	1.4	–	.95	1.4	2.0	2.8	3.0	4.4	5.1	6.7	31	40	49	55
	●	055	1.5	–	1.0	1.5	2.2	3.1	3.3	4.9	5.6	7.4	31	40	49	55
	●	06	1.6	–	1.1	1.7	2.4	3.4	3.6	5.3	6.1	8.1	31	40	49	55
	●	07	1.7	1.0	1.3	2.0	2.8	3.9	4.2	6.2	7.1	9.4	31	40	49	55
	●	08	1.8	1.2	1.5	2.2	3.2	4.5	4.8	7.1	8.2	10.8	31	40	47	53
	●	09	1.9	1.3	1.7	2.5	3.6	5.0	5.4	7.9	9.2	12.1	32	40	45	48
	●	10	2.0	1.4	1.9	2.8	3.9	5.6	6.0	8.8	10.2	13.5	32	40	45	48
	●	11	2.1	1.6	2.1	3.1	4.3	6.1	6.6	9.7	11.2	14.8	32	40	45	48
	●	12	2.2	1.7	2.3	3.4	4.7	6.7	7.2	10.6	12.2	16.2	32	40	45	48
	●	13	2.3	1.9	2.5	3.6	5.1	7.3	7.8	11.5	13.3	17.5	32	40	45	48
	●	15	2.5	2.2	2.9	4.2	5.9	8.4	9.0	13.2	15.3	20	32	40	45	48
	●	20	2.8	2.9	3.8	5.6	7.9	11.2	12.1	17.7	20	27	32	40	45	48
	●	25	3.1	3.6	4.8	7.0	9.9	14.0	15.1	22	25	34	32	40	45	48
	●	30	3.4	4.3	5.7	8.4	11.8	16.8	18.1	26	31	40	33	40	45	48
	●	40	3.9	5.8	7.6	11.2	15.8	22	24	35	41	54	34	40	45	48
	●	50	4.4	7.2	9.5	14.0	19.7	28	30	44	51	67	35	40	45	48
	●	60	4.8	8.6	11.4	16.8	24	34	36	53	61	81	35	40	45	48
●	70	5.2	10.1	13.3	19.5	28	39	42	62	71	94	35	40	45	48	
25°	●	0017	.28	–	–	–	.067	.095	.10	.15	.17	.23	–	25	35	47
	●	0025	.33	–	–	–	.099	.14	.15	.22	.25	.34	–	25	35	45
	●	0033	.38	–	–	–	.13	.18	.20	.29	.34	.45	–	25	34	44
	●	0050	.46	–	–	–	.20	.28	.30	.44	.51	.67	–	25	34	43
	●	0067	.53	–	–	–	.26	.37	.40	.59	.68	.90	–	25	34	42
	●	01	.66	–	–	.28	.39	.56	.60	.88	1.0	1.3	14	25	34	42
	●	015	.81	–	–	.42	.59	.84	.90	1.3	1.5	2.0	15	25	34	41
	●	02	.89	–	–	.56	.79	1.1	1.2	1.8	2.0	2.7	15	25	33	40
●	03	1.1	–	–	.84	1.2	1.7	1.8	2.6	3.1	4.0	15	25	33	40	
●	04	1.3	–	.76	1.1	1.6	2.2	2.4	3.5	4.1	5.4	16	25	32	39	

Other body types may be available. Contact your sales engineer for further information.
Highlighted column shows the rated pressure.

METRIC UNITS



PERFORMANCE DATA

METRIC UNITS
FLAT SPRAY NOZZLES

METRIC UNITS

PERFORMANCE DATA:
TPU AND 13802 UNIJET® SPRAY TIPS

Spray Angle at 3 bar	Tip Type	Capacity Size	Equiv. Orifice Dia. (mm)	Flow Rate Capacity (liters per minute)									Spray Angle (°)			
	TPU, 13802			.4 bar	.7 bar	1.5 bar	3 bar	6 bar	7 bar	15 bar	20 bar	35 bar	1.5 bar	3 bar	6 bar	15 bar
25°	●	05	1.4	–	.95	1.4	2.0	2.8	3.0	4.4	5.1	6.7	16	25	32	39
	●	055	1.5	–	1.0	1.5	2.2	3.1	3.3	4.9	5.6	7.4	16	25	32	39
	●	06	1.6	–	1.1	1.7	2.4	3.4	3.6	5.3	6.1	8.1	17	25	31	38
	●	07	1.7	–	1.3	2.0	2.8	3.9	4.2	6.2	7.1	9.4	17	25	31	38
	●	08	1.8	–	1.5	2.2	3.2	4.5	4.8	7.1	8.2	10.8	17	25	31	38
	●	09	1.9	–	1.7	2.5	3.6	5.0	5.4	7.9	9.2	12.1	17	25	31	38
	●	10	2.0	–	1.9	2.8	3.9	5.6	6.0	8.8	10.2	13.5	18	25	31	37
	●	13	2.3	–	2.5	3.6	5.1	7.3	7.8	11.5	13.3	17.5	18	25	31	37
	●	15	2.5	–	2.9	4.2	5.9	8.4	9.0	13.2	15.3	20	18	25	31	37
	●	20	2.8	–	3.8	5.6	7.9	11.2	12.1	17.7	20	27	19	25	31	37
	●	30	3.4	4.3	5.7	8.4	11.8	16.8	18.1	26	31	40	20	25	30	36
	●	40	3.9	5.8	7.6	11.2	15.8	22	24	35	41	54	21	25	29	35
	●	50	4.4	7.2	9.5	14.0	19.7	28	30	44	51	67	21	25	29	35
	●	60	4.8	8.6	11.4	16.8	24	34	36	53	61	81	22	25	29	35
15°	●	0017	.28	–	–	–	.067	.095	.10	.15	.17	.23	–	15	30	37
	●	0025	.33	–	–	–	.099	.14	.15	.22	.25	.34	–	15	28	34
	●	0033	.38	–	–	–	.13	.18	.20	.29	.34	.45	–	15	27	32
	●	0050	.46	–	–	–	.20	.28	.30	.44	.51	.67	–	15	26	30
	●	0067	.53	–	–	–	.26	.37	.40	.59	.68	.90	–	15	25	29
	●	01	.66	–	–	–	.39	.56	.60	.88	1.0	1.3	–	15	24	28
	●	015	.81	–	–	–	.59	.84	.90	1.3	1.5	2.0	–	15	23	27
	●	02	.89	–	–	.56	.79	1.1	1.2	1.8	2.0	2.7	6	15	22	27
	●	03	1.1	–	–	.84	1.2	1.7	1.8	2.6	3.1	4.0	6	15	22	27
	●	04	1.3	–	–	1.1	1.6	2.2	2.4	3.5	4.1	5.4	7	15	21	26
	●	05	1.4	–	–	1.4	2.0	2.8	3.0	4.4	5.1	6.7	7	15	21	26
	●	055	1.5	–	–	1.5	2.2	3.1	3.3	4.9	5.6	7.4	7	15	21	26
	●	06	1.6	–	–	1.7	2.4	3.4	3.6	5.3	6.1	8.1	8	15	21	26
	●	07	1.7	–	–	2.0	2.8	3.9	4.2	6.2	7.1	9.4	8	15	21	26
	●	08	1.8	–	–	2.2	3.2	4.5	4.8	7.1	8.2	10.8	9	15	20	25
	●	09	1.9	–	–	2.5	3.6	5.0	5.4	7.9	9.2	12.1	9	15	20	25
	●	10	2.0	–	–	2.8	3.9	5.6	6.0	8.8	10.2	13.5	10	15	19	24
	●	11	2.1	–	2.1	3.1	4.3	6.1	6.6	9.7	11.2	14.8	10	15	19	24
	●	12	2.2	1.7	2.3	3.4	4.7	6.7	7.2	10.6	12.2	16.2	10	15	19	24
	●	15	2.5	2.2	2.9	4.2	5.9	8.4	9.0	13.2	15.3	20	10	15	19	24
	●	20	2.8	2.9	3.8	5.6	7.9	11.2	12.1	17.7	20	27	10	15	19	23
	●	30	3.4	4.3	5.7	8.4	11.8	16.8	18.1	26	31	40	10	15	19	21
	●	40	3.9	5.8	7.6	11.2	15.8	22	24	35	41	54	10	15	18	21
	●	50	4.4	7.2	9.5	14.0	19.7	28	30	44	51	67	11	15	18	21
●	60	4.8	8.6	11.4	16.8	24	34	36	53	61	81	11	15	18	21	
●	70	5.2	10.1	13.3	19.5	28	39	42	62	71	94	11	15	18	21	

Other body types may be available. Contact your sales engineer for further information.
Highlighted column shows the rated pressure.



PERFORMANCE DATA:
TPU AND 13802 UNIJET® SPRAY TIPS

Spray Angle at 3 bar	Tip Type	Capacity Size	Equiv. Orifice Dia. (mm)	Flow Rate Capacity (liters per minute)									Spray Angle (°)			
	TPU, 13802			.4 bar	.7 bar	1.5 bar	3 bar	6 bar	7 bar	15 bar	20 bar	35 bar	1.5 bar	3 bar	6 bar	15 bar
0°	●	0009	.20	.013	.017	.025	.036	.050	.054	.079	.092	.12	0 Solid Stream			
	●	0012	.25	.017	.023	.034	.047	.067	.072	.11	.12	.16				
	●	0019	.30	.027	.036	.053	.075	.11	.11	.17	.19	.26				
	●	0021	.33	.030	.040	.059	.083	.12	.13	.19	.21	.28				
	●	0033	.41	.048	.063	.092	.13	.18	.20	.29	.34	.45				
	●	0050	.48	.072	.095	.14	.20	.28	.30	.44	.51	.67				
	●	0067	.58	.097	.13	.19	.26	.37	.40	.59	.68	.90				
	●	01	.71	.14	.19	.28	.39	.56	.60	.88	1.0	1.3				
	●	015	.86	.22	.29	.42	.59	.84	.90	1.3	1.5	2.0				
	●	02	.99	.29	.38	.56	.79	1.1	1.2	1.8	2.0	2.7				
	●	03	1.2	.43	.57	.84	1.2	1.7	1.8	2.6	3.1	4.0				
	●	04	1.4	.58	.76	1.1	1.6	2.2	2.4	3.5	4.1	5.4				
	●	045	1.5	.65	.86	1.3	1.8	2.5	2.7	4.0	4.6	6.1				
	●	05	1.6	.72	.95	1.4	2.0	2.8	3.0	4.4	5.1	6.7				
	●	055	1.7	.79	1.0	1.5	2.2	3.1	3.3	4.9	5.6	7.4				
	●	06	1.7	.86	1.1	1.7	2.4	3.4	3.6	5.3	6.1	8.1				
	●	065	1.8	.94	1.2	1.8	2.6	3.6	3.9	5.7	6.6	8.8				
	●	07	1.9	1.0	1.3	2.0	2.8	3.9	4.2	6.2	7.1	9.4				
	●	08	2.0	1.2	1.5	2.2	3.2	4.5	4.8	7.1	8.2	10.8				
	●	09	2.1	1.3	1.7	2.5	3.6	5.0	5.4	7.9	9.2	12.1				
●	10	2.2	1.4	1.9	2.8	3.9	5.6	6.0	8.8	10.2	13.5					
●	11	2.3	1.6	2.1	3.1	4.3	6.1	6.6	9.7	11.2	14.8					
●	12	2.4	1.7	2.3	3.4	4.7	6.7	7.2	10.6	12.2	16.2					
●	15	2.7	2.2	2.9	4.2	5.9	8.4	9.0	13.2	15.3	20					
●	20	3.1	2.9	3.8	5.6	7.9	11.2	12.1	17.7	20	27					
●	30	3.6	4.3	5.7	8.4	11.8	16.8	18.1	26	31	40					
●	40	4.1	5.8	7.6	11.2	15.8	22	24	35	41	54					

Other body types may be available. Contact your sales engineer for further information.
Highlighted column shows the rated pressure.

METRIC UNITS



PERFORMANCE DATA:
14784 UNIJET® SPRAY TIPS

Spray Angle at 3 bar	Tip Type	Capacity Size	Flow Rate Capacity (liters per minute)						
	14784		1 bar	2 bar	3 bar	4 bar	6 bar	8 bar	10 bar
80°	●	40	9.1	12.9	15.8	18.2	22.3	25.8	28.8
	●	50	11.4	16.1	19.7	22.8	27.9	32.2	36.0
	●	60	13.7	19.3	23.7	27.4	33.5	38.7	43.2
	●	70	16.0	22.6	27.6	31.9	39.1	45.1	50.5
	●	100	22.8	32.2	39.5	45.6	55.8	64.5	72.1
	●	128	29.2	41.3	50.5	58.4	71.5	82.5	92.3
65°	●	40	9.1	12.9	15.8	18.2	22.3	25.8	28.8
	●	50	11.4	16.1	19.7	22.8	27.9	32.2	36.0
	●	60	13.7	19.3	23.7	27.4	33.5	38.7	43.2
	●	70	16.0	22.6	27.6	31.9	39.1	45.1	50.5
	●	100	22.8	32.2	39.5	45.6	55.8	64.5	72.1
50°	●	20	4.6	6.4	7.9	9.1	11.2	12.9	14.4
	●	40	9.1	12.9	15.8	18.2	22.3	25.8	28.8
	●	50	11.4	16.1	19.7	22.8	27.9	32.2	36.0
	●	60	13.7	19.3	23.7	27.4	33.5	38.7	43.2
	●	70	16.0	22.6	27.6	31.9	39.1	45.1	50.5
	●	100	22.8	32.2	39.5	45.6	55.8	64.5	72.1
40°	●	20	4.6	6.4	7.9	9.1	11.2	12.9	14.4
	●	50	11.4	16.1	19.7	22.8	27.9	32.2	36.0
	●	100	22.8	32.2	39.5	45.6	55.8	64.5	72.1
25°	●	50	11.4	16.1	19.7	22.8	27.9	32.2	36.0
	●	100	22.8	32.2	39.5	45.6	55.8	64.5	72.1
	●	120	27.4	38.7	47.4	54.7	67.0	77.4	86.5
	●	125	28.5	40.3	49.4	57.0	69.8	80.6	90.1
15°	●	100	22.8	32.2	39.5	45.6	55.8	64.5	72.1

Other body types may be available. Contact your sales engineer for further information.

DIMENSIONS AND WEIGHTS

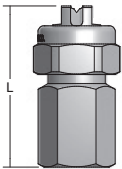
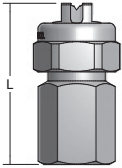
Nozzle	Nozzle Type	Inlet Conn. (in.)	L (mm)	Hex. (in.)	Net Weight (kg)
	T (F) + TPU TT (M) + TPU	1/4	40.9	13/16	.06
	T (F) + 13802 TT (M) + 13802	1/4	48.0	13/16	.06

Based on the largest/heaviest version of each type.

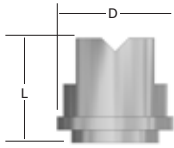
Nozzle	Spray Tip Type	L (mm)	D (mm)	Flats (mm)
	14784	25.4	25.4	19.1



**PERFORMANCE DATA
18897 VEEJET® SPRAY TIPS**

Spray Angle at 3 bar	Tip Type	Capacity Size	Equiv. Orifice Dia. (mm)	Flow Rate Capacity (liters per minute)						
	18897			.5 bar	1 bar	2 bar	4 bar	6 bar	8 bar	10 bar
110°	●	20	2.8	3.2	4.6	6.4	9.1	11.2	12.9	14.4
	●	25	3.2	4.0	5.7	8.1	11.4	14.0	16.1	18.0
	●	30	3.6	4.8	6.8	9.7	13.7	16.7	19.3	22
	●	40	4.0	6.4	9.1	12.9	18.2	22	26	29
	●	50	4.4	8.1	11.4	16.1	23	28	32	36
	●	60	4.8	9.7	13.7	19.3	27	33	39	43
	●	80	5.6	12.9	18.2	26	36	45	52	58
	●	120	6.8	19.3	27	39	55	67	77	86
	●	200	8.7	32	46	64	91	112	129	144
80°	●	20	2.8	3.2	4.6	6.4	9.1	11.2	12.9	14.4
	●	25	3.2	4.0	5.7	8.1	11.4	14.0	16.1	18.0
	●	30	3.6	4.8	6.8	9.7	13.7	16.7	19.3	22
	●	40	4.0	6.4	9.1	12.9	18.2	22	26	29
	●	50	4.4	8.1	11.4	16.1	23	28	32	36
	●	60	4.8	9.7	13.7	19.3	27	33	39	43
	●	80	5.6	12.9	18.2	26	36	45	52	58
	●	120	6.8	19.3	27	39	55	67	77	86
	●	200	8.7	32	46	64	91	112	129	144
65°	●	20	2.8	3.2	4.6	6.4	9.1	11.2	12.9	14.4
	●	25	3.2	4.0	5.7	8.1	11.4	14.0	16.1	18.0
	●	30	3.6	4.8	6.8	9.7	13.7	16.7	19.3	22
	●	40	4.0	6.4	9.1	12.9	18.2	22	26	29
	●	50	4.4	8.1	11.4	16.1	23	28	32	36
	●	60	4.8	9.7	13.7	19.3	27	33	39	43
	●	80	5.6	12.9	18.2	26	36	45	52	58
	●	100	6.4	16.2	23	32	46	56	64	72
	●	120	6.8	19.3	27	39	55	67	77	86
	●	200	8.7	32	46	64	91	112	129	144
50°	●	20	2.8	3.2	4.6	6.4	9.1	11.2	12.9	14.4
	●	25	3.2	4.0	5.7	8.1	11.4	14.0	16.1	18.0
	●	30	3.6	4.8	6.8	9.7	13.7	16.7	19.3	22
	●	40	4.0	6.4	9.1	12.9	18.2	22	26	29
	●	50	4.4	8.1	11.4	16.1	23	28	32	36



PERFORMANCE DATA

METRIC UNITS
FLAT SPRAY NOZZLES

METRIC UNITS

PERFORMANCE DATA
18897 VEEJET® SPRAY TIPS

Spray Angle at 3 bar	Tip Type	Capacity Size	Equiv. Orifice Dia. (mm)	Flow Rate Capacity (liters per minute)						
	18897			.5 bar	1 bar	2 bar	4 bar	6 bar	8 bar	10 bar
50°	●	60	4.8	9.7	13.7	19.3	27	33	39	43
	●	80	5.6	12.9	18.2	26	36	45	52	58
	●	120	6.8	19.3	27	39	55	67	77	86
	●	200	8.7	32	46	64	91	112	129	144
40°	●	20	2.8	3.2	4.6	6.4	9.1	11.2	12.9	14.4
	●	25	3.2	4.0	5.7	8.1	11.4	14.0	16.1	18.0
	●	30	3.6	4.8	6.8	9.7	13.7	16.7	19.3	22
	●	40	4.0	6.4	9.1	12.9	18.2	22	26	29
	●	50	4.4	8.1	11.4	16.1	23	28	32	36
	●	60	4.8	9.7	13.7	19.3	27	33	39	43
	●	80	5.6	12.9	18.2	26	36	45	52	58
	●	90	6.0	14.6	21	29	41	50	58	65
	●	100	6.4	16.2	23	32	46	56	64	72
	●	120	6.8	19.3	27	39	55	67	77	86
25°	●	200	8.7	32	46	64	91	112	129	144
	●	20	2.8	3.2	4.6	6.4	9.1	11.2	12.9	14.4
	●	25	3.2	4.0	5.7	8.1	11.4	14.0	16.1	18.0
	●	30	3.6	4.8	6.8	9.7	13.7	16.7	19.3	22
	●	40	4.0	6.4	9.1	12.9	18.2	22	26	29
	●	50	4.4	8.1	11.4	16.1	23	28	32	36
	●	60	4.8	9.7	13.7	19.3	27	33	39	43
	●	80	5.6	12.9	18.2	26	36	45	52	58
	●	100	6.4	16.2	23	32	46	56	64	72
	●	120	6.8	19.3	27	39	55	67	77	86
15°	●	200	8.7	32	46	64	91	112	129	144
	●	20	2.8	3.2	4.6	6.4	9.1	11.2	12.9	14.4
	●	25	3.2	4.0	5.7	8.1	11.4	14.0	16.1	18.0
	●	30	3.6	4.8	6.8	9.7	13.7	16.7	19.3	22
	●	40	4.0	6.4	9.1	12.9	18.2	22	26	29
	●	50	4.4	8.1	11.4	16.1	23	28	32	36
	●	60	4.8	9.7	13.7	19.3	27	33	39	43
	●	80	5.6	12.9	18.2	26	36	45	52	58
●	120	6.8	19.3	27	39	55	67	77	86	



PERFORMANCE DATA
49803 AND 49807 VEEJET® SPRAY TIPS

Spray Angle at 2.8 bar	Tip Type		Capacity Size	Flow Rate Capacity (liters per minute)					
	49803	49807		2 bar	3 bar	4 bar	5.5 bar	7 bar	10 bar
110°		●	0067	.22	.260	.31	.36	.40	.48
		●	02	.64	.79	.91	1.06	1.20	1.40
		●	04	1.30	1.60	1.80	2.16	2.40	2.90
		●	06	1.90	2.40	2.70	3.22	3.60	4.30
		●	08	2.60	3.20	3.60	4.28	4.80	5.80
	●		40	12.88	15.78	18.22	22.31	24.10	28.80
	●		50	16.11	19.73	22.78	27.90	3.13	36.02
95°		●	02	.64	.79	.91	1.06	1.20	1.40
		●	04	.97	1.18	1.37	1.60	1.81	2.16
		●	06	1.90	2.40	2.70	3.22	3.60	4.30
		●	08	2.60	3.20	3.60	4.28	4.80	5.80
	●		10	3.22	3.95	4.56	5.35	6.03	7.21
	●		15	4.82	5.92	6.84	8.02	9.08	10.81
	●		20	6.44	7.89	9.11	11.16	12.05	14.41
	●		30	9.66	11.83	13.66	16.73	18.07	21.60
	●		40	12.88	15.78	18.22	22.31	24.10	28.80
	●		50	16.11	19.73	22.78	27.90	3.13	36.02
	80°		●	01	.32	.39	.45	.53	.61
		●	02	.64	.79	.91	1.06	1.20	1.40
		●	04	1.30	1.60	1.80	2.16	2.40	2.90
		●	06	1.90	2.40	2.70	3.22	3.60	4.30
		●	08	2.60	3.20	3.60	4.28	4.80	5.80
●			10	3.22	3.95	4.56	5.35	6.03	7.21
●			15	4.82	5.92	6.84	8.02	9.08	10.81
●			20	6.44	7.89	9.11	11.16	12.05	14.41
●			30	9.66	11.83	13.66	16.73	18.07	21.60
●			40	12.88	15.78	18.22	22.31	24.10	28.80
●			50	16.11	19.73	22.78	27.90	3.13	36.02

METRIC UNITS



PERFORMANCE DATA

METRIC UNITS
FLAT SPRAY NOZZLES

METRIC UNITS

PERFORMANCE DATA
49803 AND 49807 VEEJET® SPRAY TIPS

Spray Angle at 2.8 bar	Tip Type		Capacity Size	Flow Rate Capacity (liters per minute)					
	49803	49807		2 bar	3 bar	4 bar	5.5 bar	7 bar	10 bar
75°	●		50	16.11	19.73	22.78	27.90	3.13	36.02
65°		●	015	.49	.60	.67	.79	.91	1.07
		●	02	.64	.79	.91	1.06	1.20	1.40
		●	04	1.30	1.60	1.80	2.16	2.40	2.90
		●	06	1.90	2.40	2.70	3.22	3.60	4.30
		●	08	2.60	3.20	3.60	4.28	4.80	5.80
		●	10	3.22	3.95	4.56	5.35	6.03	7.21
		●	15	4.82	5.92	6.84	8.02	9.08	10.81
		●	20	6.44	7.89	9.11	11.16	12.05	14.41
		●	30	9.66	11.83	13.66	16.73	18.07	21.60
		●	40	12.88	15.78	18.22	22.31	24.10	28.80
		●	50	16.11	19.73	22.78	27.90	3.13	36.02
60°	●		50	16.11	19.73	22.78	27.90	3.13	36.02
50°	●		30	9.66	11.83	13.66	16.73	18.07	21.60
	●		50	16.11	19.73	22.78	27.90	3.13	36.02
	●		70	22.56	27.63	31.91	37.42	42.22	5.46
45°	●		50	16.11	19.73	22.78	27.90	3.13	36.02
25°		●	0067	.220	.26	.31	.36	.40	.48
		●	015	.49	.60	.67	.79	.91	1.07
15°		●	01	.32	.39	.45	.53	.61	.72
5°		●	01	.32	.39	.45	.53	.61	.72



**PERFORMANCE DATA
58606 VEEJET® SPRAY TIPS**

Spray Angle at 3 bar	Tip Type	Capacity Size	Flow Rate Capacity (liters per minute)						
	45478		1 bar	2 bar	3 bar	4 bar	6 bar	8 bar	10 bar
110°	●	150	34.2	48.4	59.2	68.4	83.7	96.7	108.1
	●	200	45.6	64.5	79.0	91.2	111.7	128.9	144.2
80°	●	150	34.2	48.4	59.2	68.4	83.7	96.7	108.1
	●	200	45.6	64.5	79.0	91.2	111.7	128.9	144.2
65°	●	150	34.2	48.4	59.2	68.4	83.7	96.7	108.1
	●	200	45.6	64.5	79.0	91.2	111.7	128.9	144.2
	●	250	57.0	80.6	98.7	114.0	139.6	161.2	180.2
50°	●	150	34.2	48.4	59.2	68.4	83.7	96.7	108.1
	●	180	41.0	58.0	71.1	82.1	100.5	116.0	129.7
	●	200	45.6	64.5	79.0	91.2	111.7	128.9	144.2
	●	250	57.0	80.6	98.7	114.0	139.6	161.2	180.2
40°	●	150	34.2	48.4	59.2	68.4	83.7	96.7	108.1
	●	200	45.6	64.5	79.0	91.2	111.7	128.9	144.2
25°	●	130	29.6	41.9	51.3	59.3	72.6	83.8	93.7
	●	140	31.9	45.1	55.3	63.8	78.2	90.3	100.9
	●	150	34.2	48.4	59.2	68.4	83.7	96.7	108.1
	●	200	45.6	64.5	79.0	91.2	111.7	128.9	144.2
15°	●	180	41.0	58.0	71.1	82.1	100.5	116.0	129.7
	●	200	45.6	64.5	79.0	91.2	111.7	128.9	144.2

**PERFORMANCE DATA
20799 VEEJET® SPRAY TIPS**

Spray Angle at 2.8 bar	Tip Type	Capacity Size	Equiv. Orifice Dia. (mm)	Flow Rate Capacity (liters per minute)						
	20799			.5 bar	1 bar	2 bar	4 bar	6 bar	8 bar	10 bar
120°	●	12.5	2.2	2.0	2.8	4.0	5.7	7.0	8.1	9.0
	●	15	2.4	2.4	3.4	4.8	6.8	8.4	9.7	10.8
	●	20	2.8	3.2	4.6	6.4	9.1	11.2	12.9	14.4
	●	25	3.2	4.0	5.7	8.1	11.4	14.0	16.1	18.0
	●	30	3.6	4.8	6.8	9.7	13.7	16.7	19.3	22
	●	40	4.0	6.4	9.1	12.9	18.2	22	26	29
	●	50	4.4	8.1	11.4	16.1	23	28	32	36
	●	60	4.8	9.7	13.7	19.3	27	33	39	43
	●	80	5.6	12.9	18.2	26	36	45	52	58
	●	100	6.4	16.1	23	32	46	56	64	72
	●	125	6.8	20	28	40	57	70	81	90
	●	200	8.7	32	46	64	91	112	129	144



PERFORMANCE DATA

METRIC UNITS
FLAT SPRAY NOZZLES

METRIC UNITS

PERFORMANCE DATA
FSUN-S VEEJET® SPRAY TIPS

Spray Angle	Tip Retainer Size (in.)	Tip Type FSUN-S	Capacity Size	Equiv. Orifice Dia. (mm)	Flow Rate Capacity (liters per minute)					
					.5 bar	1 bar	2 bar	3 bar	5 bar	10 bar
20°, 30°, 45°, 60°, 75°, 90°, 120°	3/8	•	.6	.8	.2	.3	.4	.5	.6	.9
		•	1	1.0	.3	.5	.6	.8	1.0	1.4
		•	1.5	1.2	.5	.7	1.0	1.2	1.5	2.1
		•	2	1.4	.6	.9	1.3	1.6	2.0	2.8
		•	2.5	1.5	.8	1.1	1.6	1.9	2.5	3.5
		•	3	1.7	1.0	1.3	1.9	2.3	3.0	4.2
		•	4	2.0	1.3	1.8	2.5	3.1	4.0	5.6
		•	5	2.2	1.5	2.2	3.2	3.9	5.0	7.1
		•	6	2.5	1.9	2.7	3.8	4.6	6.0	8.5
		•	7.5	2.7	2.4	3.4	4.7	5.8	7.5	10.6
		•	10	3.0	3.2	4.5	6.3	7.8	10.0	14.1
		•	13	3.5	4.1	5.8	8.2	10.1	13.0	18.4
		•	16	4.0	5.1	7.2	10.1	12.4	16.0	22.6
		•	20	4.5	6.3	8.9	12.7	15.5	20.0	28.3
		•	25	5.0	7.9	11.2	15.8	19.4	25.0	35.4
		20°, 30°, 45°, 60°, 75°, 90°, 120°	3/4	•	32	5.5	10.1	14.3	20.2	24.8
•	40			6.0	12.7	17.9	25.3	31.0	40.0	56.6
•	10			3.0	3.2	4.5	6.3	7.8	10.0	14.1
•	13			3.5	4.1	5.8	8.2	10.1	13.0	18.4
•	16			4.0	5.1	7.2	10.1	12.4	16.0	22.6
•	20			4.5	6.3	8.9	12.7	15.5	20.0	28.3
•	25			5.0	7.9	11.2	15.8	19.4	25.0	35.4
•	32			5.5	10.1	14.3	20.2	24.8	32.0	45.3
•	40			6.0	12.7	17.9	25.3	31.0	40.0	56.6
•	50			7.0	15.8	22.4	31.6	38.7	50.0	70.7
•	63			8.0	19.9	28.2	39.8	48.8	63.0	89.1
•	80			9.0	25.3	35.8	50.6	62.0	80.0	113.1
20°, 30°, 45°, 60°, 75°, 90°, 120°	1-1/4	•	100	10.0	31.6	44.7	63.2	77.5	100.0	141.4
		•	130	11.0	41.4	58.1	82.2	100.7	130.0	183.8
		•	160	12.0	50.6	71.6	101.2	123.9	160.0	226.3
		•	200	13.0	63.2	89.4	126.5	154.9	200.0	282.8
		•	250	15.0	79.1	111.8	158.1	193.7	250.0	353.6
		•	63	8.0	19.9	28.2	39.8	48.8	63.0	89.1
		•	80	9.0	25.3	35.8	50.6	62.0	80.0	113.1



DIMENSIONS AND WEIGHTS

Spray Tip	Spray Tip Type	L (mm)	D (mm)
	18897	14.3	23.8
	20799	21.03	23.8
	58606	93.5	25.4
	49803, 49807	11.79	14.68

Based on the largest/heaviest version of each type.

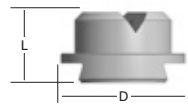
Spray Tip	Spray Tip Type	Tip Retainer Size (in.)	L (mm)	D (mm)
	FSUN-S	3/8	12	14.8
		3/4	14	24
		1-1/4	22	38.5

Based on the largest/heaviest version of each type.

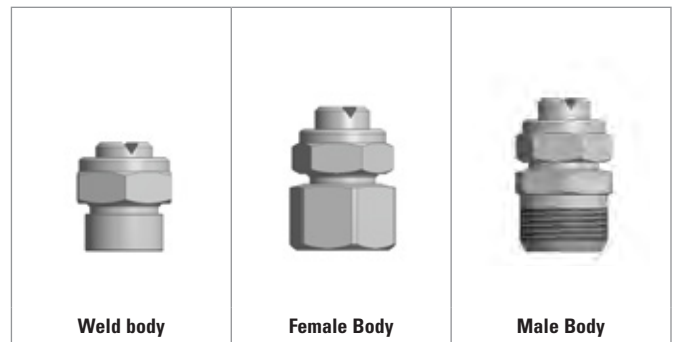

Dovetail spray tips can be used on a variety of body types. Please contact your sales engineer for body options and dimensions.

METRIC UNITS



PERFORMANCE DATA

METRIC UNITS
FULL CONE NOZZLES

METRIC UNITS

PERFORMANCE DATA
G, GG, H, HH, HF, GA AND GGA FULLJET® NOZZLES

Inlet Conn. (in.)	Nozzle Type							Capacity Size	Orifice Dia. Nom. (mm)	Max. Free Passage Dia. (mm)	Flow Rate Capacity (liters per minute)								Spray Angle (°)		
	Standard				Angle						.4 bar	.5 bar	.7 bar	1.5 bar	3 bar	6 bar	7 bar	10 bar	.5 bar	1.5 bar	6 bar
	G	GG	H	HH	HF	GA	GGA														
1/8	•	•		•				1	.79	.64	-	-	.38	.54	.74	1.0	1.1	1.3	-	58	53
	•	•		•				1.5	1.2	.64	.44	.49	.57	.80	1.1	1.5	1.6	1.9	52	65	59
	•	•		•		•	•	2	1.2	1.0	.59	.65	.76	1.1	1.5	2.0	2.2	2.6	43	50	46
	•	•		•		•	•	3	1.5	1.0	.88	.98	1.1	1.6	2.2	3.1	3.3	3.9	52	65	59
	•	•		•		•	•	3.5	1.6	1.3	1.0	1.1	1.3	1.9	2.6	3.6	3.8	4.5	43	50	46
						•	•	3.9	2.0	1.0	1.1	1.3	1.5	2.1	2.9	4.0	4.3	5.1	77	84	79
	•	•		•		•	•	5	2.0	1.3	1.5	1.6	1.9	2.7	3.7	5.1	5.5	6.5	52	65	59
1/4						•	•	6.1	2.3	1.3	1.8	2.0	2.3	3.3	4.5	6.2	6.7	7.9	69	74	68
	•	•		•		•	•	6.5	2.4	1.6	1.9	2.1	2.5	3.5	4.8	6.7	7.1	8.4	45	50	46
	•	•		•		•	•	10	3.2	1.6	3.0	3.3	3.8	5.4	7.5	10.3	11.0	13.0	58	67	61
3/8				•		•	•	12.5	3.2	1.6	3.7	4.1	4.8	6.8	9.3	12.8	13.7	16.2	69	74	68
	•	•		•		•	•	9.5	2.6	2.4	2.8	3.1	3.6	5.1	7.1	9.7	10.4	12.3	45	50	46
	•	•		•		•	•	15	3.6	2.4	4.4	4.9	5.7	8.1	11.2	15.4	16.5	19.4	64	67	61
						•	•	20	4.0	2.8	6.0	6.6	7.6	10.7	14.5	19.6	22	26	76	80	73
1/2	•	•		•		•	•	22	4.5	2.8	6.5	7.2	8.4	11.9	16.4	23	24	28	87	90	82
	•	•				•	•	16	3.5	3.2	4.7	5.2	6.1	8.7	11.9	16.4	17.6	21	48	50	46
	•	•		•		•	•	25	4.6	3.2	7.4	8.2	9.5	13.5	18.6	26	27	32	64	67	61
	•	•		•		•	•	32	5.2	3.6	9.4	10.4	12.2	17.3	24	33	35	41	72	75	68
	•	•		•		•	•	40	6.2	3.6	11.9	13.1	15.2	21	29	39	44	52	88	91	83
3/4						•	•	50	6.7	4.0	14.7	16.3	19.1	27	37	51	55	65	91	94	86
			•	•				2.5	4.9	4.4	8.7	9.6	11.2	15.9	22	30	32	38	48	50	46
			•	•				4.0	6.4	4.4	13.9	15.4	18.0	26	35	48	52	61	67	70	63
1			•	•				7.0	9.5	5.2	24	27	31	45	61	84	91	107	89	92	84
			•	•				4.2	6.0	5.6	14.6	16.2	18.9	27	37	51	54	64	48	50	46
			•	•				7.0	8.3	5.6	24	27	31	45	61	84	91	107	67	68	62
			•	•				8.0	9.5	5.6	28	31	36	51	70	97	104	122	72	81	82
			•	•				10	11.9	5.6	35	38	45	64	88	121	130	153	78	90	94
1-1/4			•	•				12	11.9	6.4	42	46	54	77	105	145	155	183	89	92	84
			•					6	7.4	6.4	21	23	27	38	53	72	78	92	48	50	44
			•					10	9.6	6.4	35	38	45	64	88	121	130	153	64	67	58
			•					12	10.7	6.4	42	46	54	77	105	145	155	183	66	70	60
			•					14	12.3	6.4	49	54	63	89	123	169	181	214	77	80	70
			•					16	12.7	7.9	56	62	72	102	140	193	207	244	73	76	66
		•					20	15.1	7.9	69	77	90	128	175	241	259	305	90	93	81	

Maximum Free Passage Diameter is the maximum diameter as listed of foreign matter that can pass through the nozzle without clogging. Highlighted column shows the rated pressure.



**PERFORMANCE DATA
G, GG, H, HH, HF, GA AND GGA FULLJET® NOZZLES**

Inlet Conn. (in.)	Nozzle Type						Capacity Size	Orifice Dia. Nom. (mm)	Max. Free Passage Dia. (mm)	Flow Rate Capacity (liters per minute)								Spray Angle (°)		
	Standard			Angle						.4 bar	.5 bar	.7 bar	1.5 bar	3 bar	6 bar	7 bar	10 bar	.5 bar	1.5 bar	6 bar
	G	GG	H	HH	HF	GA				GGA										
1-1/2			●				10	9.5	8.7	35	38	45	64	88	121	130	153	48	50	44
			●				16	12.7	8.7	56	62	72	102	140	193	207	244	72	74	64
			●				20	14.3	8.7	69	77	90	128	175	241	259	305	74	76	66
			●				30*	18.3	10.3	104	115	135	191	263	362	389	458	91	94	82
2			●				17	12.7	11.1	59	65	76	108	149	205	220	259	49	50	44
			●				30	17.3	11.1	104	115	135	191	263	362	389	458	72	74	64
			●				35	19.2	11.1	122	135	157	223	307	422	453	534	75	77	68
			●				40	21.0	11.1	139	154	180	255	351	483	518	611	78	80	70
			●				50*	23.8	14.3	174	192	225	319	439	603	648	763	83	85	75
			●				60*	28.6	14.3	208	231	269	383	526	724	777	916	98	100	86
2-1/2			●				25	15.1	14.3	87	96	112	159	219	302	324	382	49	50	44
			●				50	22.2	14.3	174	192	225	319	439	603	648	763	72	74	64
			●				60	24.6	14.3	208	231	269	383	526	724	777	916	76	78	68
			●				70	28.6	14.3	243	269	314	446	614	845	907	1068	79	82	72
			●				80	28.6	17.5	278	308	359	510	702	965	1036	1221	86	88	77
			●				90	30.2	17.5	312	346	404	574	790	1086	1166	1374	95	97	84
			●				42	19.1	17.5	146	162	189	268	368	507	544	641	49	50	44
			●				80	27.8	17.5	278	308	359	510	702	965	1036	1221	81	84	73
3			●				90	30.2	17.5	312	346	404	574	790	1086	1166	1374	86	89	77
			●				100	32.5	17.5	347	385	449	638	877	1207	1295	1526	92	95	83
			●				110	33.3	18.2	382	423	494	702	965	1327	1425	1679	86	89	77
			●				120	34.9	20.6	417	462	539	765	1053	1448	1554	1832	102	105	89
			●	●			160	42.9	19.1	556	616	719	1020	1404	1931	2073	2442	87	90	70
			●	●			180	47.2	22.2	625	693	808	1148	1579	2172	2332	2747	92	95	83
4			●	●			200	50.8	25.4	694	769	898	1276	1755	2413	2591	3053	97	100	87
			●	●			210	54.8	25.4	729	808	943	1339	1842	2534	2720	3205	102	105	91
			●	●			250	47.6	28.6	868	962	1123	1594	2193	3017	3238	3816	89	91	80
			●	●			280	52.8	28.6	972	1077	1258	1786	2456	3379	3627	4274	93	96	84
			●	●			320	68.3	34.9	1111	1231	1437	2041	2807	3861	4145	4884	97	100	87
5			●	●			330	72.2	34.9	1146	1270	1482	2105	2895	3982	4275	5037	102	105	91
			●	●			350	61.1	41.3	1215	1347	1572	2232	3070	4223	4534	5342	87	90	78
			●	●			400	69.1	41.3	1389	1539	1797	2551	3509	4827	5181	6105	92	95	83
			●	●			450	77	44.5	1562	1731	2021	2870	3948	5430	5829	6868	97	100	87
6			●	●			480	81.8	44.5	1667	1847	2156	3061	4211	5792	6218	7326	102	105	91
			●	●			500	69.9	47.6	1736	1924	2246	3189	4386	6033	6477	7632	78	80	70
			●	●			600	80.2	47.6	2083	2308	2695	3827	5264	7240	7772	9158	86	88	77
			●	●			700	91.3	47.6	2430	2693	3144	4464	6141	8447	9068	10684	92	95	83
8			●	●			800	102	57.2	2778	3078	3593	5102	7018	9654	10363	12211	102	105	91
			●	●			900	124	57.2	3125	3463	4042	5740	7895	10860	11658	13737	106	110	96
			●	●			800	85.1	63.5	2778	3078	3593	5102	7018	9654	10363	12211	78	80	70
10			●	●			1000	101	63.5	3472	3847	4492	6378	8773	12067	12954	15263	86	89	77
			●	●			1200	122	66.7	4167	4617	5390	7653	10527	14480	15544	18316	97	100	87
			●	●			1300	135	66.7	4514	5002	5839	8291	11404	15687	16840	19842	103	106	92

Maximum Free Passage Diameter is the maximum diameter as listed of foreign matter that can pass through the nozzle without clogging.
 *These capacity sizes are not available for H in polypropylene.
 Highlighted column shows the rated pressure.

METRIC UNITS

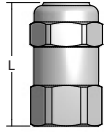
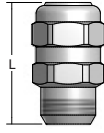

DIMENSIONS AND WEIGHTS

Nozzle	Nozzle Type	Inlet Conn. (in.)	L (mm)	Hex. (in.)	Net Weight (kg)
	G (F)	1/8	55.6	9/16	.03
		1/4	37.3	11/16	.04
		3/8	46.0	13/16	.07
		1/2	57.2	1	.17
	GG (M)	1/8	32.5	9/16	.02
		1/4	39.7	11/16	.04
		3/8	46.8	13/16	.07
		1/2	56.4	1	.17

Based on the largest/heaviest version of each type.

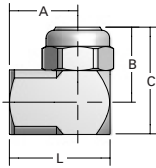
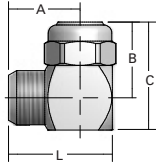
Nozzle	Nozzle Type	Inlet Conn. (in.)	L (mm)	A (mm)	B (mm)	C (mm)	Net Weight (kg)
	GA (F)	1/8	23.1	16.0	14.3	21.4	.04
		1/4	28.7	20.1	19.8	28.6	.06
		3/8	32.5	22.2	30.2	40.5	.09
		1/2	39.7	27.0	34.5	47.2	.18
	GGA (M)	1/8	23.9	16.8	14.3	21.4	.04
		1/4	29.5	20.8	19.8	28.6	.06
		3/8	33.3	23.0	30.2	40.5	.09
		1/2	40.9	28.2	34.5	47.2	.18

Based on the largest/heaviest version of each type.

DIMENSIONS AND WEIGHTS

Nozzle	Nozzle Type	Inlet Conn. (in.)	L (mm)	D (Dia.) (mm)	Net Weight (kg)
	H (F)	3/4	55.6	31.8	.21
		1	69.4	38.1	.35
	H (F) Cast	1-1/4	87.4	52.4 oct.	.73
		1-1/2	103.2	58.7 oct.	.72
		2	138.2	76.2 oct.	1.11
		2-1/2	160.3	87.3 oct.	2.15
		3	187.3	103.2 oct.	2.70
		4	242.9	138.1 oct.	5.44
	H (F) Cast (Standard angle only) Wide angle not available in Cast for these sizes	5	293.7	171.5 oct.	13.97
		6	365.1	203.2 oct.	22.23
	HF (Flange)	4	206.4	222.3	13.06
		5	268.2	254.0	15.56
		6	320.7	279.4	22.23
		8	422.3	342.9	54.43
		10	527.1	406.4	87.54
	HH (M)	1/8	22.2	12.7	.01
		1/4	22.4	13.5	.01
		3/8	23.9	16.7	.03
		1/2	29.4	20.6	.04
		3/4	38.9	27.0	.10
		1	51.6	33.3	.20

Based on the largest/heaviest version of each type.

METRIC UNITS



PERFORMANCE DATA

**METRIC UNITS
FULL CONE NOZZLES**

METRIC UNITS

**PERFORMANCE DATA
HMFP AND HHMFP MAXIMUM FREE PASSAGE FULLJET® NOZZLES**

Inlet Conn. (in.)	Nozzle Type		Capacity Size	Approx. Free Passage Dia. (mm)	Flow Rate Capacity (liters per minute)				Spray Angle (°)					
									60° Series		90° Series		115° Series	
	HMFP	HHMFP			.7 bar	1.5 bar	3 bar	6 bar	.7 bar	3 bar	.07 bar	3 bar	.7 bar	3 bar
3/8	●	●	14	3.2	5.3	7.2	9.5	12.6	60	62	90	84	115	100
	●	●	22	4.0	8.4	11.4	15.0	19.8	60	62	90	84	115	100
	●	●	32	4.8	12.2	16.5	22	29	60	62	90	84	115	100
1/2	●	●	32	4.8	12.2	16.5	22	29	60	62	90	84	115	100
	●	●	51	5.5	19.4	26	35	46	60	62	90	84	115	100
	●	●	57	6.4	22	29	39	51	60	62	90	84	115	100
3/4	●	●	70	7.1	27	36	48	63	60	62	90	84	115	100
	●	●	84	7.9	32	43	57	76	60	62	90	84	115	100
	●	●	100	8.7	38	52	68	90	60	62	90	84	115	100
	●	●	120	9.5	46	62	82	108	60	62	90	84	115	100
1	●	●	120	9.5	46	62	82	108	60	62	90	84	115	100
	●	●	150	10.3	57	76	99	129	60	62	90	88	115	105
	●	●	170	11.1	65	86	113	146	60	62	90	88	115	105
1-1/4	●	●	170	11.1	65	86	113	146	60	62	90	88	115	105
	●	●	200	11.9	76	102	132	172	60	62	90	88	115	105
	●	●	220	12.7	84	112	146	189	60	62	90	88	115	105
	●	●	240	13.5	91	122	159	207	60	62	90	88	115	105
	●	●	260	14.3	99	132	172	224	60	62	90	88	115	105
	●	●	240	13.7	91	126	170	227	60	59	89	89	108	104
1-1/2	●	●	260	14.2	99	137	184	246	62	61	90	92	113	103
	●	●	280	14.5	107	147	198	265	62	62	89	91	113	107
	●	●	300	15.0	114	164	226	313	63	62	93	92	114	108
	●	●	350	16.0	133	191	264	365	63	63	91	93	117	113
	●	●	400	16.8	153	218	302	418	64	64	92	93	120	115
	●	●	450	17.8	172	245	339	470	65	63	92	91	117	116
	●	●	500	19.3	191	274	382	533	59	58	90	86	103	98
2	●	●	600	20.8	229	329	459	639	61	58	89	86	108	102
	●	●	700	21.8	267	384	535	746	62	57	92	91	114	106
	●	●	800	24.6	305	439	612	852	60	57	93	89	113	111
	●	●	1000	25.4	381	539	739	1013	61	58	92	90	112	112
2-1/2	●	●	1200	30.7	457	647	887	1216	63	59	94	91	110	108
	●	●	1400	34.5	534	755	1035	1419	62	60	93	92	113	111
	●	●	1700	35.8	648	917	1257	1723	62	60	89	88	112	110
	●	●	1800	25.4	686	949	1274	1712	61	59	90	92	112	108
3	●	●	2000	43.9	762	1054	1416	1902	63	61	93	91	112	109
	●	●	2400	55.9	914	1265	1699	2282	62	60	95	93	114	111

Approximate Free Passage Diameter is the approximate diameter as listed of foreign matter that can pass through the nozzle without clogging.



DIMENSIONS AND WEIGHTS

Nozzle	Nozzle Type	Inlet Conn. (in.)	Spray Angle	Capacity Size	L (mm)	Hex. (in.)	Net Weight (kg)
	HMFP (F)	3/8	60°, 90°, 115°	14, 22	37.3	13/16	.07
			60°, 90°, 115°	32	43.2	13/16	.07
		1/2	60°, 90°, 115°	32	45.0	1	.13
			60°, 90°, 115°	51, 57	53.9	1	.13
		3/4	60°, 90°, 115°	70	61.0	1-1/4	.25
			60°, 90°, 115°	84	67.0	1-3/8	.36
			60°, 90°, 115°	100	73.5	1-3/8	.38
		60°, 90°, 115°	120	78.0	1-3/8	.37	
		1	60°, 90°, 115°	120, 150, 170	82.6	1-3/4	.64
		1-1/4	60°, 90°, 115°	170, 200, 220, 240, 260	95.3	2	.86
1-1/2	60°, 90°, 115°	240, 260, 280, 300, 350, 400, 450	111.3	2-3/16	1		
	HMFP (F) Cast	2	60°, 90°, 115°	500, 600, 700, 800	165.8	2-3/4 dia.	1.5
		2-1/2	60°, 90°, 115°	1000, 1200, 1400, 1700	203.2	3-3/16 dia.	2.65
		3	60°, 90°, 115°	1800, 2000, 2400	239.8	4-3/16 dia.	3.25
	HHMFP (M)	3/8	60°, 90°, 115°	14, 22	25.4	11/16	.04
			60°, 90°, 115°	32	43.2	3/4	.06
		1/2	60°, 90°, 115°	32	31.1	7/8	.07
			60°, 90°, 115°	51, 57	55.8	1	.14
		3/4	60°, 90°, 115°	70	46.0	1-1/8	.14
			60°, 90°, 115°	84	68.9	1-3/8	.33
			60°, 90°, 115°	100	75.7	1-3/8	.34
		60°, 90°, 115°	120	78.7	1-3/8	.33	
		1	60°, 90°, 115°	120, 150, 170	82.6	1-3/4	.64
		1-1/4	60°, 90°, 115°	170, 200, 220, 240, 260	95.3	2	.91
1-1/2	60°, 90°, 115°	240, 260, 280, 300, 350, 400, 450	111.3	2-3/16	1.04		
	HHMFP (M) Cast	2	60°, 90°, 115°	500, 600, 700, 800	165.8	2-3/4 dia.	1.5
		2-1/2	60°, 90°, 115°	1000, 1200, 1400, 1700	203.2	3-3/16 dia.	2.65
		3	60°, 90°, 115°	1800, 2000, 2400	239.8	4-3/16 dia.	3.25

Based on the largest/heaviest version of each type.

METRIC UNITS



PERFORMANCE DATA

METRIC UNITS
FULL CONE NOZZLES

METRIC UNITS

PERFORMANCE DATA
HHSJ SPIRALJET® NOZZLES

Inlet Conn. (in.)	Nozzle Type	Spray Angle at .7 bar					Capacity Size	Orifice Dia. Nom. (mm)	Max. Free Passage Dia. (mm)	Flow Rate Capacity (liters per minute)				
		HHSJ	60°	90°	120°	150°				170°	.7 bar	1.5 bar	3 bar	7 bar
1/4	•	•	•	•			07	2.4	2.4	2.7	3.9	5.5	8.4	16.0
	•	•	•	•	•	•	13	3.2	3.2	5.0	7.3	10.3	15.7	30
	•	•	•	•	•	•	20	4.0	3.2	7.6	11.2	15.8	24	46
3/8	•	•					07	2.4	2.4	2.7	3.9	5.5	8.4	16.0
	•	•					13	3.2	3.2	5.0	7.3	10.3	15.7	30
	•	•					20	4.0	3.2	7.6	11.2	15.8	24	46
	•	•	•	•	•	•	30	4.8	3.2	11.4	16.8	24	36	68
	•	•	•	•	•	•	40	5.6	3.2	15.3	22	32	48	91
	•	•	•	•	•	•	53	6.4	3.2	20	30	42	64	121
	•	•	•	•	•	•	82	7.9	3.2	31	46	65	99	187
1/2	•	•	•	•	•	•	120	9.5	4.8	46	67	95	145	274
	•	•	•	•	•	•	164	11.1	4.8	63	92	129	198	374
	•					•	210	12.7	4.8	80	117	166	253	479
3/4	•	•	•	•	•	•	210	12.7	4.8	80	117	166	253	479
1	•	•	•	•	•	•	340	15.9	6.4	130	190	268	410	775
	•	•	•	•	•	•	470	19.1	6.4	179	262	371	567	1071
1-1/2	•	•	•	•	•	•	640	22.2	7.9	244	357	505	772	1459
	•	•	•	•	•	•	820	25.4	7.9	313	458	647	989	1869
	•	•	•	•	•	•	960	28.6	7.9	366	536	758	1158	2188
2	•	•	•	•	•	•	1400	34.9	11.1	534	782	1105	1689	3191
	•	•	•	•	•	•	1780	38.1	11.1	679	994	1406	2147	4057
3	•	•	•	•			2560	44.5	14.3	976	1429	2021	3088	5835
	•	•	•	•			3360	50.8	14.3	1282	1876	2653	4053	7659
4	•	•	•	•			5250	63.5	15.9	2002	2931	4145	6332	11967

Maximum Free Passage Diameter is the maximum diameter as listed of foreign matter that can pass through the nozzle without clogging. Highlighted column shows the rated pressure.



PERFORMANCE DATA
HHSJX SPIRALJET® NOZZLES

Inlet Conn. (in.)	Nozzle Type	Spray Angle at 7 bar		Capacity Size	Orifice Dia. Nom. (mm)	Max. Free Passage Dia. (mm)	Flow Rate Capacity (liters per minute)				
		90°	120°				.7 bar	1.5 bar	3 bar	7 bar	25 bar
3/8	•	•	•	30	4.8	4.8	11.4	16.8	24	36	68
	•	•	•	40	5.6	5.6	15.3	22	32	48	91
	•	•	•	53	6.4	6.4	20	30	42	64	121
	•	•	•	82	7.9	7.9	31	46	65	99	187
1/2	•	•	•	120	9.5	9.5	46	67	95	145	274
	•	•	•	164	11.1	11.1	63	92	129	198	374
3/4	•	•	•	210	12.7	12.7	80	117	166	253	479
1	•	•	•	340	15.9	15.9	130	190	268	410	775
	•	•	•	470	19.1	19.1	179	262	371	567	1071
1-1/2	•	•	•	640	22.2	22.2	244	357	505	772	1459
	•	•	•	820	25.4	25.4	313	458	647	989	1869
	•	•	•	960	28.6	28.6	366	536	758	1158	2188
2	•	•	•	1400	34.9	34.9	534	782	1105	1689	3191
	•	•	•	1780	38.1	38.1	679	994	1406	2147	4057

Maximum Free Passage Diameter is the maximum diameter as listed of foreign matter that can pass through the nozzle without clogging. Highlighted column shows the rated pressure.

DIMENSIONS AND WEIGHTS

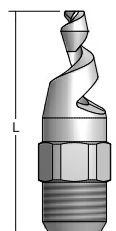
Nozzle	Nozzle Type	Inlet Conn. (in.)	L (mm)	Hex. (in.)	Net Weight (kg)
	HHSJ (M)	1/4	54.0	9/16	.03
		3/8	60.3	11/16	.05
		1/2	79.4	7/8	.10
		3/4	87.3	1-1/16	.15
		1	115.9	1-3/8	.28
		1-1/2	171.5	2	.77
		2	174.6	2-1/2	.99
		3	301.6	3-3/4	2.61
		4	228.6	4-1/2	4.65

Based on the largest/heaviest version of each type.

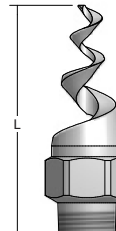
Nozzle	Nozzle Type	Inlet Conn. (in.)	L (mm)	Hex. (in.)	Net Weight (kg)
	HHSJX (M)	3/8	69.9	7/8	.09
		1/2	85.7	1-1/16	.13
		3/4	117.5	1-3/8	.23
		1	130.2	1-3/4	.51
		1-1/2	171.5	2	.85
		2	279.4	3	2.49

Based on the largest/heaviest version of each type.



PERFORMANCE DATA

METRIC UNITS
FULL CONE NOZZLES

METRIC UNITS

PERFORMANCE DATA
VK FULLJET® NOZZLES

Inlet Conn. (in.)	Nozzle Type	Capacity Size	Flow Rate Capacity (liters per minute)						Max. Free Passage (mm) at Spray Angle (°)			
			.5 bar	1 bar	2 bar	3 bar	5 bar	10 bar	45	60	90	120
3/8 F	VK	1.5	.5	.7	1.0	1.2	1.5	2.1	.70	1.10	.80	.75
	•	2	.6	.9	1.3	1.6	2.0	2.8	.80	1.2	.80	.80
	•	2.5	.8	1.1	1.6	1.9	2.5	3.5	1.20	1.15	1.00	.90
	•	3.5	1.1	1.6	2.2	2.7	3.5	4.9	1.25	1.20	1.10	1.00
	•	4	1.3	1.8	2.5	3.1	4.0	5.7	1.40	1.25	1.15	1.10
	•	4.5	1.4	2.0	2.8	3.5	4.5	6.4	1.40	1.30	1.15	1.10
	•	5	1.6	2.2	3.2	3.8	5.0	7.1	1.55	1.50	1.20	1.20
	•	6	1.7	2.7	3.8	4.7	6.0	8.5	1.60	1.60	1.40	1.30
	•	7	2.2	3.1	4.4	5.4	7.0	9.9	1.80	1.65	1.55	1.40
	•	8	2.5	3.6	5.0	6.2	8.0	11.4	1.95	1.70	1.70	1.55
	•	9	2.8	4.0	5.7	7.0	9.0	12.7	1.95	1.85	1.70	1.55
	•	10	3.2	4.5	6.4	7.8	10.0	14.2	2.00	1.85	1.75	1.60
	•	11	3.5	4.9	7.0	8.5	11.0	15.6	2.00	1.85	1.75	1.60
	•	12	3.8	5.4	7.6	9.3	12.0	17.0	2.05	1.90	1.80	1.65
	•	13	4.1	5.8	8.2	10.1	13.0	18.4	2.10	1.90	1.80	1.70
	•	14	4.4	6.3	8.9	10.8	14.0	19.8	2.10	1.95	1.85	1.70
	•	15	4.7	6.7	9.5	11.6	15.0	21.2	2.15	2.00	1.85	1.75
	•	16	5.1	7.2	10.1	12.4	16.0	22.7	2.20	2.10	1.90	1.80
	•	17	5.4	7.6	10.8	13.2	17.0	24.0	2.20	2.10	1.90	1.80
	•	18	5.7	8.0	11.4	13.9	18.0	25.5	2.25	2.15	1.95	1.85
•	19	6.0	8.5	12.0	14.7	19.0	26.9	2.25	2.15	1.95	1.85	
•	20	6.3	9.0	12.7	15.5	20.0	28.4	2.30	2.20	2.00	1.90	
3/8 M	•	5	1.6	2.2	3.2	3.8	5.0	7.1	1.55	1.50	1.20	1.20
	•	6	1.7	2.7	3.8	4.7	6.0	8.5	1.60	1.60	1.40	1.30
	•	8	2.5	3.6	5.0	6.2	8.0	11.4	1.95	1.70	1.70	1.55
	•	10	3.2	4.5	6.4	7.8	10.0	14.2	2.00	1.85	1.75	1.60
	•	13	4.1	5.8	8.2	10.1	13.0	18.4	2.10	1.90	1.80	1.70
	•	16	5.1	7.2	10.1	12.4	16.0	22.7	2.20	2.10	1.90	1.80
	•	20	6.3	9.0	12.7	15.5	20.0	28.4	2.30	2.20	2.00	1.90
1/2 M	•	20	6.3	9.0	12.7	15.5	20.0	28.4	2.30	2.20	2.00	1.90
	•	25	7.9	11.2	15.8	19.4	25.0	35.4	2.00	2.50	2.10	2.00
	•	32	10.1	14.3	20.2	24.8	32.0	45.3	2.80	2.60	2.50	2.30
	•	40	12.7	17.9	25.3	30.9	40.0	56.6	3.00	2.80	2.70	2.50
3/4 M	•	40	12.7	17.9	25.3	30.9	40.0	56.6	3.00	2.80	2.70	2.50
	•	50	15.8	22.4	31.6	38.7	50.0	70.7	3.20	2.90	2.80	2.70
	•	63	19.9	28.2	39.8	48.8	63.0	89.1	3.40	3.10	3.00	2.90

F = female threads (type IG), M = male threads (type AG)

DIMENSIONS AND WEIGHTS

Nozzle	Nozzle Type	Inlet Conn. (in.)	L (mm)	D (mm)	Hex. (in.)
	VK-AG (M)	3/8	20	—	3/4
		1/2	26	—	1
		3/4	28	—	1-1/4

F = female thread; M = male thread. BSPP threads.

Nozzle	Nozzle Type	Inlet Conn. (in.)	L (mm)	D (mm)	Hex. (in.)
	VK-IG (F)	3/8	26.5	21	7/8

F = female thread; M = male thread. BSPP threads.



**PERFORMANCE DATA
GANV AND GGANV FULLJET® NOZZLES**

Inlet Conn. (in.)	Nozzle Type		Capacity Size	Orifice Dia. Nom. (mm)	Max. Free Passage Dia. (mm)	Flow Rate Capacity (liters per minute)								Spray Angle (°)		
	GANV	GGANV				.4 bar	.5 bar	.7 bar	1 bar	1.5 bar	3 bar	6 bar	7 bar	.5 bar	1.5 bar	6 bar
1/4	●	●	5	2.8	2.0	1.4	1.6	1.9	2.3	2.8	3.9	5.6	6.0	68	75	82
	●	●	7	3.2	2.4	2.0	2.3	2.7	3.2	3.9	5.5	7.8	8.4	68	75	82
	●	●	8	4.0	2.8	2.3	2.6	3.1	3.6	4.5	6.3	8.9	9.6	75	80	85
	●	●	10	4.0	3.2	2.9	3.2	3.8	4.6	5.6	7.9	11.2	12.1	75	80	85
	●	●	11	4.0	3.6	3.2	3.5	4.2	5.0	6.1	8.7	12.3	13.3	75	80	85
3/8	●	●	11	4.4	3.2	3.2	3.5	4.2	5.0	6.1	8.7	12.3	13.3	75	85	83
	●	●	13	4.4	3.6	3.7	4.2	5.0	5.9	7.3	10.3	14.5	15.7	75	85	83
	●	●	16	4.4	4.0	4.6	5.2	6.1	7.3	8.9	12.6	17.9	19.3	75	85	83
	●	●	20	5.6	4.4	5.8	6.4	7.6	9.1	11.2	15.8	22	24	75	85	83
	●	●	23	5.6	4.8	6.6	7.4	8.8	10.5	12.8	18.2	26	28	75	85	83
	●	●	26	6.0	5.2	7.5	8.4	9.9	11.9	14.5	21	29	31	75	85	83
	●	●	29	6.0	5.6	8.4	9.3	11.1	13.2	16.2	23	32	35	75	85	83
	●	●	33	7.5	6.0	9.5	10.6	12.6	15.0	18.4	26	37	40	75	85	83
1/2	●	●	32	7.9	5.2	9.2	10.3	12.2	14.6	17.9	25	36	39	85	90	95
	●	●	40	7.9	6.0	11.5	12.9	15.3	18.2	22	32	45	48	85	90	95
	●	●	48	7.9	7.1	13.8	15.5	18.3	22	27	38	54	58	85	90	95
	●	●	56	9.9	7.5	16.1	18.1	21	26	31	44	63	68	85	90	95
	●	●	64	9.9	8.3	18.5	21	24	29	36	51	71	77	85	90	95
	●	●	72	9.9	9.1	21	23	27	33	40	57	80	87	85	90	95

Maximum Free Passage Diameter is the maximum diameter as listed of foreign matter that can pass through the nozzle without clogging. Highlighted column shows the rated pressure.

DIMENSIONS AND WEIGHTS

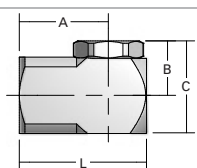
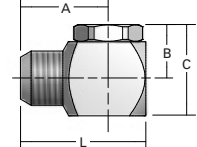
Nozzle	Nozzle Type	Inlet Conn. (in.)	L (mm)	A (mm)	B (mm)	C (mm)	Net Weight (kg)
	GANV (F)	1/4	29.4	19.8	22.2	31.0	.06
		3/8	32.5	22.2	25.4	36.5	.09
		1/2	39.7	27.0	38.9	51.6	.18
	GGANV (M)	1/4	29.4	20.6	22.2	31.8	.06
		3/8	33.3	23.0	25.4	36.5	.09
		1/2	41.3	28.6	38.9	51.6	.18

Based on the largest/heaviest version of each type.



PERFORMANCE DATA

METRIC UNITS
FULL CONE NOZZLES

METRIC UNITS

PERFORMANCE DATA
R, RR AND RF DISTRIBOJET® NOZZLES

Inlet Conn. (in.)	Nozzle Type												Capacity Size	Flow Rate Capacity (liters per minute)							
	R				RR				RF					.1 bar	.2 bar	.4 bar	.5 bar	.7 bar	1.5 bar	3 bar	4 bar
	Spray Angle																				
	50°	65°	80°	95°	50°	65°	80°	95°	50°	65°	80°	95°									
2	•	•		•	•	•		•					45	122	168	231	256	298	424	583	665
		•		•		•		•					60	163	224	308	341	398	565	777	887
2-1/2	•	•		•	•	•		•					70	190	261	359	398	464	659	907	1035
		•		•		•		•					90	244	335	461	511	597	848	1166	1331
3	•	•		•	•	•		•					110	298	410	564	625	730	1036	1425	1627
		•		•		•		•					140	379	522	718	795	929	1318	1814	2070
4	•	•	•		•	•	•		•	•	•		160	434	596	820	909	1061	1507	2073	2366
	•	•		•	•	•		•	•	•		•	190	515	708	974	1079	1260	1789	2461	2809
		•		•		•		•		•		•	250	677	932	1282	1420	1658	2354	3238	3697
5	•	•	•		•	•	•		•	•	•		250	677	932	1282	1420	1658	2354	3238	3697
	•	•		•	•	•		•	•	•		•	280	759	1044	1436	1591	1857	2637	3627	4140
		•		•		•		•		•		•	380	1030	1416	1948	2159	2520	3579	4922	5619
6	•	•	•		•	•	•		•	•	•		360	975	1342	1846	2045	2388	3390	4663	5323
	•	•		•	•	•		•	•	•		•	400	1084	1491	2051	2273	2653	3767	5181	5915
		•		•		•		•		•		•	560	1517	2087	2871	3182	3714	5274	7254	8280
8	•	•	•		•	•	•		•	•	•		650	1761	2423	3333	3693	4311	6121	8420	9611
	•	•		•	•	•		•	•	•		•	750	2032	2795	3845	4261	4974	7063	9715	11090
		•		•		•		•		•		•	850	2303	3168	4358	4829	5637	8005	11011	12569
				•				•				•	1000	2710	3727	5127	5681	6632	9417	12954	14787
12												•	1400	3794	5218	7178	7954	9285	13184	18135	20701
												•	1600	4335	5964	8203	9090	10612	15067	20726	23658
												•	1700	4606	6336	8716	9658	11275	16009	22021	25137
												•	1800	4877	6709	9229	10226	11938	16951	23317	26616
												•	2000	5419	7455	10254	11363	13265	18834	25907	29573
												•	2200	5961	8200	11279	12499	14591	20718	28498	32530

For orifice information, contact your sales engineer.
Highlighted column shows the rated pressure.

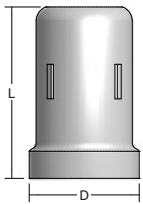
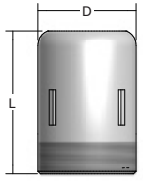
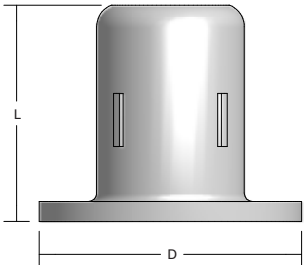

DIMENSIONS AND WEIGHTS

Nozzle	Nozzle Type	Inlet Conn. (in.)	L (mm)	D (Dia.) (mm)	Net Weight (kg)
	R (F)	2	112.7	74.6	1.36
		2-1/2	138.9	88.1	2.49
		3	165.1	104.8	3.40
		4	206.4	127.0	6.12
		5	254.8	161.9	14.97
		6	300.0	193.7	17.46
		8	388.9	241.3	34.02
	RR (M)	2	82.6	60.3	.91
		2-1/2	101.6	73.0	2.38
		3	123.8	88.9	2.61
		4	165.1	114.3	4.54
		5	211.1	141.3	11.34
		6	247.7	168.3	13.15
		8	330.2	219.1	25.40
	RF (Flange)	4	166.7	225.4	10.43
		5	223.8	250.8	17.69
		6	249.2	276.2	20.41
		8	330.2	339.7	38.56
		12	495.3	482.6	91.17

Based on the largest/heaviest version of each type.

METRIC UNITS



**PERFORMANCE DATA
G-SQ, GG-SQ AND HH-SQ FULLJET® NOZZLES**

Inlet Conn. (in.)	Nozzle Type			Capacity Size	Orifice Dia. Nom. (mm)	Max. Free Passage Dia. (mm)	Flow Rate Capacity (liters per minute)										Spray Angle (°)		
	G-SQ	GG-SQ	HH-SQ				.4 bar	.5 bar	.7 bar	1.5 bar	3 bar	6 bar	7 bar	10 bar	.5 bar	1.5 bar	6 bar		
1/8	●	●	●	3.6SQ	1.6	1.3	1.1	1.2	1.4	1.9	2.7	3.7	4.0	4.7	40	52	47		
	●	●	●	4.8SQ	1.9	1.3	1.4	1.6	1.8	2.6	3.6	4.9	5.3	6.2	48	63	57		
	●	●	●	6SQ	2.4	1.3	1.8	2.0	2.3	3.2	4.5	6.1	6.6	7.8	60	66	60		
1/4	●	●	●	10SQ	2.8	1.6	2.9	3.3	3.8	5.4	7.4	10.2	11.0	13.0	62	67	61		
	●	●	●	12SQ	3.2	1.6	3.5	3.9	4.6	6.5	8.9	12.3	13.2	15.5	70	75	68		
			●	14.5SQ	3.9	1.6	4.3	4.7	5.5	7.8	10.8	14.8	15.9	18.8	78	82	75		
3/8	●	●	●	18SQ	4.0	2.4	5.3	5.9	6.9	9.7	13.4	18.4	19.8	23	71	75	68		
1/2	●	●	●	29SQ	5.6	3.2	8.5	9.5	11.1	15.7	22	30	32	38	71	75	68		
			●	36SQ	6.4	3.2	10.6	11.8	13.7	19.5	27	37	40	47	78	82	75		
3/4			●	50SQ	6.7	4.4	14.7	16.3	19.1	27	37	51	55	65	71	75	68		
1			●	106SQ	9.9	5.6	31	35	40	57	79	109	117	137	78	80	73		

Maximum Free Passage Diameter is the maximum diameter as listed of foreign matter that can pass through the nozzle without clogging. Highlighted column shows the rated pressure.

DIMENSIONS AND WEIGHTS

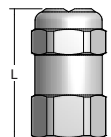
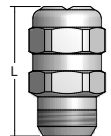
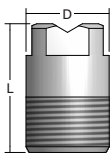
Nozzle	Nozzle Type	Inlet Conn. (in.)	L (mm)	Hex. (in.)	D (Dia.) (mm)	Net Weight (kg)
	G-SQ (F)	1/8	28.5	9/16	—	.03
		1/4	34.1	11/16	—	.04
	GG-SQ (M)	1/8	30.1	9/16	—	.01
		1/4	36.5	11/16	—	.01
	HH-SQ (M)	1/8	22.2	—	12.7	.01
		1/4	22.2	—	13.5	.02
		3/8	23.8	—	16.7	.05
		1/2	28.7	—	20.6	.10
		3/4	38.9	—	27.0	.04
		1	51.6	—	33.3	.37

Based on the largest/heaviest version of each type.

PERFORMANCE DATA
TG UNIJET® SPRAY TIPS

Body Inlet Conn. (in.)	UniJet Tip Type	Capacity Size	Orifice Dia. Nom. (mm)	Max. Free Passage Dia. (mm)	Flow Rate Capacity (liters per minute)								Spray Angle (°)		
	TG				.4 bar	.5 bar	.7 bar	1.5 bar	3 bar	6 bar	7 bar	10 bar	.5 bar	1.5 bar	6 bar
1/4	●	.3	.51	.41	–	–	–	.16	.22	.31	.33	.39	–	50	61
	●	.4	.56	.46	–	–	–	.22	.30	.41	.44	.52	–	56	63
	●	.5	.61	.51	–	–	–	.27	.37	.51	.55	.65	–	56	63
	●	.6	.69	.51	–	–	–	.32	.45	.61	.66	.78	–	54	62
	●	.7	.76	.51	–	–	–	.38	.52	.72	.77	.91	–	54	63
	●	1	.94	.64	–	–	.38	.54	.74	1.0	1.1	1.3	–	58	53
	●	2	1.19	1.0	.59	.65	.76	1.1	1.5	2.0	2.2	2.6	43	50	46
	●	3	1.57	1.0	.88	.98	1.1	1.6	2.2	3.1	3.3	3.9	52	65	59
	●	3.5	1.70	1.3	1.0	1.1	1.3	1.9	2.6	3.6	3.8	4.5	43	50	46
	●	5	2.08	1.3	1.5	1.6	1.9	2.7	3.7	5.1	5.5	6.5	52	65	59
	●	6.5	2.38	1.6	1.9	2.1	2.5	3.5	4.8	6.7	7.1	8.4	45	50	46
●	10	3.18	1.6	3.0	3.3	3.8	5.4	7.5	10.3	11.0	13.0	58	67	61	

Maximum Free Passage Diameter is the maximum diameter as listed of foreign matter that can pass through the nozzle without clogging. Other body sizes may be available. Contact your sales engineer for further information. Highlighted column shows the rated pressure.

PERFORMANCE DATA
TG-SQ UNIJET® SPRAY TIPS

Body Inlet Conn. (in.)	UniJet Tip Type	Capacity Size	Orifice Dia. Nom. (mm)	Max. Free Passage Dia. (mm)	Flow Rate Capacity (liters per minute)								Spray Angle (°)		
	TG-SQ				.4 bar	.5 bar	.7 bar	1.5 bar	3 bar	6 bar	7 bar	10 bar	.5 bar	1.5 bar	6 bar
1/4	●	6SQ	2.4	1.3	1.8	2.0	2.3	3.2	4.5	6.1	6.6	7.8	60	66	60
	●	8SQ	2.5	1.3	2.4	2.6	3.0	4.3	6.0	8.2	8.8	10.4	70	75	68
	●	10SQ	2.8	1.6	2.9	3.3	3.8	5.4	7.4	10.2	11.0	13.0	62	66	60
	●	12SQ	3.2	1.6	3.5	3.9	4.6	6.5	8.9	12.3	13.2	15.5	70	75	68
3/8	●	18SQ	4.0	2.4	5.3	5.9	6.9	9.7	13.4	18.4	19.8	23	71	75	68

Maximum Free Passage Diameter is the maximum diameter as listed of foreign matter that can pass through the nozzle without clogging. Other body sizes may be available. Contact your sales engineer for further information. Highlighted column shows the rated pressure.

DIMENSIONS AND WEIGHTS

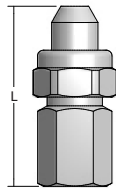
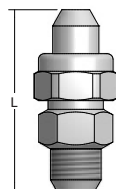
Nozzle	Nozzle Type	Inlet Conn. (in.)	L (mm)	Hex. (in.)	Net Weight (kg)
	T (F) + TG	1/4	46.8	13/16	.06
	TT (M) + TG	1/4	46.8	13/16	.06

Based on the largest/heaviest version of each type. Additional sizes are available.

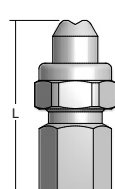
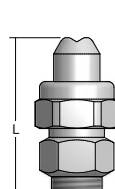
Nozzle	Nozzle Type	Inlet Conn. (in.)	L (mm)	Hex. (in.)	Net Weight (kg)
	T (F) + TG-SQ TT (M) + TG-SQ	1/4	57.9	13/16	.05
		3/8	58.1	13/16	.06

Based on the largest/heaviest version of each type. Additional sizes are available.



PERFORMANCE DATA

METRIC UNITS
FULL CONE NOZZLES: OVAL SPRAY

METRIC UNITS

PERFORMANCE DATA
G-VL, GG-VL AND HH-VL FULLJET® NOZZLES

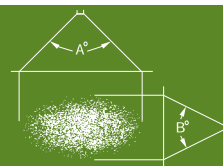

Inlet Conn. (in.)	Nozzle Type			Capacity Size	Max. Free Passage Dia. (mm)	Flow Rate Capacity (liters per minute)							Spray Angle (°)							
						1 bar	2 bar	3 bar	4 bar	6 bar	7 bar	10 bar	1 bar		3 bar		7 bar		10 bar	
	A	B	A										B	A	B	A	B			
3/8	●	●	●	4.9VL	1.0	2.2	3.0	3.6	4.2	5.0	5.4	6.3	104	66	90	60	86	52	83	47
	●	●	●	6.5VL	1.3	2.9	4.0	4.8	5.5	6.7	7.1	8.4	106	64	95	60	85	50	81	45
	●	●	●	8.1VL	1.3	3.6	5.0	6.0	6.9	8.3	8.9	10.5	102	64	100	65	84	50	80	45
	●	●	●	9.2VL	1.3	4.1	5.7	6.8	7.8	9.4	10.1	11.9	103	65	100	65	86	51	81	46

Maximum Free Passage Diameter is the maximum diameter as listed of foreign matter that can pass through the nozzle without clogging.
Calibration pressure = 10 psi (.7 bar).

DIMENSIONS AND WEIGHTS

Nozzle	Nozzle Type	Inlet Conn. (in.)	L (mm)	Hex. (in.)	D (Dia.) (mm)	Net Weight (kg)
	G-VL (F)	3/8	38.1	13/16	57.1	.06
	GG-VL (M)	3/8	38.1	13/16	57.1	.05
	HH-VL (M)	1/2	45	7/8	-	.08

Based on the largest/heaviest version of each type.



**PERFORMANCE DATA
AX AND BX WHIRLJET® NOZZLES**

Inlet Conn. (in.)	Nozzle Type		Capacity Size	Inlet Dia. Nom. (mm)	Orifice Dia. Nom. (mm)	Flow Rate Capacity (liters per minute)											Spray Angle (°)		
	AX	BX				.2 bar	.4 bar	.7 bar	1 bar	1.5 bar	2 bar	3 bar	4 bar	6 bar	7 bar	.7 bar	1.5 bar	6 bar	
1/8	●	●	5	.79	1.2	–	–	.19	.23	.28	.32	.39	.46	.56	.60	39	58	69	
	●	●	1	1.6	1.6	–	–	.38	.46	.56	.64	.79	.91	1.1	1.2	41	64	76	
	●	●	2	2.0	2.0	–	.58	.76	.91	1.1	1.3	1.6	1.8	2.2	2.4	52	61	69	
	●	●	3	2.4	2.4	–	.86	1.1	1.4	1.7	1.9	2.4	2.7	3.4	3.6	52	64	77	
	●	●	5	3.2	3.2	1.0	1.4	1.9	2.3	2.8	3.2	3.9	4.6	5.6	6.0	56	67	76	
	●	●	8	4.0	4.0	1.6	2.3	3.1	3.6	4.5	5.2	6.3	7.3	8.9	9.6	56	65	70	
	●	●	10	4.4	4.4	2.0	2.9	3.8	4.6	5.6	6.4	7.9	9.1	11.2	12.1	55	65	72	
1/4	●	●	1	1.6	1.6	–	–	.38	.46	.56	.64	.79	.91	1.1	1.2	47	53	67	
	●	●	2	2.0	2.0	–	–	.76	.91	1.1	1.3	1.6	1.8	2.2	2.4	56	62	71	
	●	●	3	2.4	2.4	–	.86	1.1	1.4	1.7	1.9	2.4	2.7	3.4	3.6	51	65	78	
	●	●	5	3.6	3.6	1.0	1.4	1.9	2.3	2.8	3.2	3.9	4.6	5.6	6.0	63	73	79	
	●	●	8	4.0	4.0	1.6	2.3	3.1	3.6	4.5	5.2	6.3	7.3	8.9	9.6	61	69	73	
	●	●	10	4.8	4.4	2.0	2.9	3.8	4.6	5.6	6.4	7.9	9.1	11.2	12.1	63	70	74	
	●	●	15	5.9	5.2	3.1	4.3	5.7	6.8	8.4	9.7	11.8	13.7	16.8	18.1	63	71	72	
3/8	●	●	5	3.6	3.2	1.0	1.4	1.9	2.3	2.8	3.2	3.9	4.6	5.6	6.0	64	73	79	
	●	●	8	4.4	4.0	1.6	2.3	3.1	3.6	4.5	5.2	6.3	7.3	8.9	9.6	62	70	74	
	●	●	10	5.2	4.4	2.0	2.9	3.8	4.6	5.6	6.4	7.9	9.1	11.2	12.1	64	72	75	
	●	●	15	5.9	5.6	3.1	4.3	5.7	6.8	8.4	9.7	11.8	13.7	16.8	18.1	64	72	74	
	●	●	20	7.1	6.4	4.1	5.8	7.6	9.1	11.2	12.9	15.8	18.2	22	24	63	70	74	
	●	●	25	7.5	7.5	5.1	7.2	9.5	11.4	14.0	16.1	19.7	23	28	30	63	70	74	
	●	●	30	8.3	7.9	6.1	8.6	11.4	13.7	16.8	19.3	24	27	34	36	63	70	74	
1/2	●	●	25	9.5	6.4	5.1	7.2	9.5	11.4	14.0	16.1	19.7	23	28	30	63	66	71	
	●	●	30	9.5	7.5	6.1	8.6	11.4	13.7	16.8	19.3	24	27	34	36	67	71	75	
	●	●	40	9.5	9.1	8.2	11.5	15.3	18.2	22	26	32	36	45	48	72	76	78	
	●	●	50	9.5	11.1	10.2	14.4	19.1	23	28	32	39	46	56	60	74	79	82	
	●	●	60	9.5	13.1	12.2	17.3	23	27	34	39	47	55	67	72	77	82	86	
3/4	●	●	40	12.7	7.9	8.2	11.5	15.3	18.2	22	26	32	36	45	48	70	73	74	
	●	●	50	12.7	9.5	10.2	14.4	19.1	23	28	32	39	46	56	60	72	75	77	
	●	●	60	12.7	11.1	12.2	17.3	23	27	34	39	47	55	67	72	74	76	79	
	●	●	70	12.7	12.7	14.3	20	27	32	39	45	55	64	78	84	76	79	83	
	●	●	80	12.7	14.3	16.3	23	31	36	45	52	63	73	89	96	78	82	84	
	●	●	90	12.7	14.7	18.3	26	34	41	50	58	71	82	101	109	81	84	84	
	●	●	100	12.7	15.9	20	29	38	46	56	64	79	91	112	121	83	86	86	
	●	●	110	12.7	17.1	22	32	42	50	61	71	87	100	123	133	85	88	88	
	●	●	120	12.7	18.3	24	35	46	55	67	77	95	109	134	145	87	90	90	

Intermediate capacities: Caps are interchangeable for in-between capacities within each pipe size group. Request Data Sheets 3055, 3986 and 3987.
 Spray dimension data: Request Data Sheets 15350 and 15362.
 Highlighted column shows the rated pressure.



PERFORMANCE DATA

METRIC UNITS
HOLLOW CONE NOZZLES

METRIC UNITS

PERFORMANCE DATA
CX WHIRLJET® NOZZLES

Inlet Conn. (in.)	Nozzle Type CX	Capacity Size	Inlet Dia. Nom. (mm)	Orifice Dia. Nom. (mm)	Flow Rate Capacity (liters per minute)												Spray Angle (°)		
					.2 bar	.3 bar	.4 bar	.5 bar	.7 bar	1 bar	1.5 bar	2 bar	3 bar	4 bar	6 bar	7 bar	.5 bar	1.5 bar	4 bar
1	●	7	17.5	11.5	17.1	21	24	27	32	38	47	54	66	76	93	101	64	65	66
	●	8	17.5	12.7	19.5	24	28	31	36	44	53	62	76	87	107	115	65	66	67
	●	9	17.5	14.3	22	27	31	35	41	49	60	69	85	98	120	130	66	67	69
	●	10	17.5	15.5	24	30	34	39	46	54	67	77	94	109	133	144	67	69	71
	●	12	17.5	17.1	29	36	41	46	55	65	80	92	113	131	160	173	70	73	75
	●	15	17.5	20.6	37	45	52	58	68	82	100	116	142	163	200	216	76	79	81
1-1/4	●	10	21.4	14.3	24	30	34	39	46	54	67	77	94	109	133	144	65	67	67
	●	12	21.4	16.3	29	36	41	46	55	65	80	92	113	131	160	173	68	70	71
	●	14	21.4	18.3	34	42	48	54	64	76	93	108	132	153	187	202	71	73	75
	●	16	21.4	20.2	39	48	55	62	73	87	107	123	151	174	214	231	74	75	77
	●	20	21.4	24.2	49	60	69	77	91	109	133	154	189	218	267	288	76	77	79
1-1/2	●	16	27.8	17.5	39	48	55	62	73	87	107	123	151	174	214	231	64	67	69
	●	20	27.8	21.8	49	60	69	77	91	109	133	154	189	218	267	288	69	72	74
	●	25	27.8	25.8	61	75	86	96	114	136	167	193	236	272	334	360	72	74	76
	●	30	27.8	28.6	73	90	103	116	137	163	200	231	283	327	400	432	74	76	78
2	●	30	36.5	23.8	73	90	103	116	137	163	200	231	283	327	400	432	66	67	70
	●	35	36.5	27.0	85	104	121	135	160	191	234	270	330	381	467	505	68	70	73
	●	40	36.5	30.2	97	119	138	154	182	218	267	308	378	436	534	577	70	72	75
	●	45	36.5	32.9	110	134	155	173	205	245	300	347	425	490	601	649	72	74	78
	●	50	36.5	36.1	122	149	172	193	228	272	334	385	472	545	667	721	74	77	82
	●	60	36.5	39.7	146	179	207	231	274	327	400	462	566	654	801	865	77	79	84
2-1/2	●	60	47.6	36.1	146	179	207	231	274	327	400	462	566	654	801	865	67	68	71
	●	70	47.6	40.5	171	209	241	270	319	381	467	539	661	763	934	1009	69	71	74
	●	80	47.6	44.1	195	239	276	308	365	436	534	616	755	872	1068	1153	71	73	77
	●	90	47.6	47.6	219	269	310	347	410	490	601	694	849	981	1201	1297	73	75	80
	●	100	47.6	50.8	244	298	345	385	456	545	667	771	944	1090	1335	1442	77	79	83

Highlighted column shows the rated pressure.



**PERFORMANCE DATA
CF WHIRLJET® NOZZLES**

Inlet Conn. (in.)	Nozzle Type	Capacity Size	Inlet Dia. Nom. (mm)	Orifice Dia. Nom. (mm)	Flow Rate Capacity (liters per minute)										Spray Angle (°)		
	CF				.2 bar	.4 bar	.5 bar	.7 bar	1.5 bar	2 bar	3 bar	4 bar	6 bar	7 bar	.5 bar	1.5 bar	4 bar
4	●	150	79.4	50.8	366	517	578	684	1001	1156	1416	1635	2002	2162	66	67	70
	●	175	79.4	59.1	426	603	674	798	1168	1349	1652	1907	2336	2523	68	70	71
	●	200	79.4	68.3	487	689	771	912	1335	1541	1888	2180	2669	2883	70	72	74
	●	225	79.4	74.6	548	775	867	1026	1502	1734	2123	2452	3003	3244	72	74	77
	●	250	79.4	82.6	609	862	963	1140	1668	1926	2359	2724	3337	3604	74	76	81
	●	275	79.4	92.1	670	948	1060	1254	1835	2119	2595	2997	3670	3964	78	80	83
	●	150-45	79.4	50.8	366	517	578	684	1001	1156	1416	1635	2002	2162	45	49	52
	●	175-45	79.4	59.1	426	603	674	798	1168	1349	1652	1907	2336	2523	45	49	51
	●	200-45	79.4	68.3	487	689	771	912	1335	1541	1888	2180	2669	2883	45	48	51
	●	225-45	79.4	74.6	548	775	867	1026	1502	1734	2123	2452	3003	3244	45	48	50
	●	250-45	79.4	82.6	609	862	963	1140	1668	1926	2359	2724	3337	3604	45	47	49
6	●	250	124	62.3	609	862	963	1140	1668	1926	2359	2724	3337	3604	65	67	69
	●	300	124	69.9	731	1034	1156	1368	2002	2312	2831	3269	4004	4325	66	68	70
	●	350	124	76.2	853	1206	1349	1596	2336	2697	3303	3814	4671	5046	68	70	72
	●	400	124	82.6	975	1378	1541	1824	2669	3082	3775	4359	5339	5767	70	73	75
	●	450	124	88.1	1097	1551	1734	2051	3003	3468	4247	4904	6006	6487	72	75	77
	●	500	124	97.2	1218	1723	1926	2279	3337	3853	4719	5449	6673	7208	74	76	79
	●	550	124	108	1340	1895	2119	2507	3670	4238	5191	5994	7341	7929	76	79	83
	●	625	124	130	1523	2154	2408	2849	4171	4816	5899	6811	8342	9010	78	81	86
	●	440-65	124	88.1	1072	1516	1695	2006	2936	3391	4153	4795	5873	6343	60	61	62
	●	550-65	124	108	1340	1895	2119	2507	3670	4238	5191	5994	7341	7929	64	65	66
	●	625-65	124	130	1523	2154	2408	2849	4171	4816	5899	6811	8342	9010	65	66	67

Highlighted column shows the rated pressure.

**PERFORMANCE DATA
E WHIRLJET® NOZZLES**

Inlet Conn. (in.)	Nozzle Type	Capacity Size	Inlet Dia. Nom. (mm)	Orifice Dia. Nom. (mm)	Flow Rate Capacity (liters per minute)										Spray Angle (°)			
	E				.2 bar	.4 bar	.5 bar	.7 bar	1 bar	1.5 bar	2 bar	3 bar	4 bar	6 bar	7 bar	.5 bar	1.5 bar	6 bar
1/4	●	2	1.6	6.4	—	—	—	.76	.91	1.1	1.3	1.6	1.8	2.2	2.4	—	165	158
	●	5	2.4	6.4	1.0	1.4	1.6	1.9	2.3	2.8	3.2	3.9	4.6	5.6	6.0	164	154	147
	●	5.8	2.8	6.4	1.2	1.7	1.9	2.2	2.6	3.2	3.7	4.6	5.3	6.5	7.0	164	154	147
	●	8	3.2	7.9	1.6	2.3	2.6	3.1	3.6	4.5	5.2	6.3	7.3	8.9	9.6	164	160	151
	●	10	3.6	7.9	2.0	2.9	3.2	3.8	4.6	5.6	6.4	7.9	9.1	11.2	12.1	164	154	147
3/8	●	8	2.8	12.3	1.6	2.3	2.6	3.1	3.6	4.5	5.2	6.3	7.3	8.9	9.6	164	160	157
	●	10	3.2	12.3	2.0	2.9	3.2	3.8	4.6	5.6	6.4	7.9	9.1	11.2	12.1	164	160	157
	●	15	4.4	12.3	3.1	4.3	4.8	5.7	6.8	8.4	9.7	11.8	13.7	16.8	18.1	165	163	155
	●	20	5.2	12.3	4.1	5.8	6.4	7.6	9.1	11.2	12.9	15.8	18.2	22	24	162	152	147
	●	25	5.9	12.3	5.1	7.2	8.1	9.5	11.4	14.0	16.1	19.7	23	28	30	162	158	154
	●	33	6.7	16.3	6.7	9.5	10.6	12.6	15.0	18.4	21	26	30	37	40	162	154	148
1/2	●	53	9.5	16.3	10.8	15.3	17.1	20	24	30	34	42	48	59	64	159	152	149
	●	25	5.6	16.3	5.1	7.2	8.1	9.5	11.4	14.0	16.1	19.7	23	28	30	162	158	154
	●	30	6.4	16.3	6.1	8.6	9.7	11.4	13.7	16.8	19.3	24	27	34	36	163	155	148
	●	40	7.5	16.3	8.2	11.5	12.9	15.3	18.2	22	26	32	36	45	48	160	152	144
●	53	9.5	16.3	10.8	15.3	17.1	20	24	30	34	42	48	59	64	159	152	149	

Highlighted column shows the rated pressure.

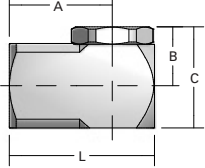
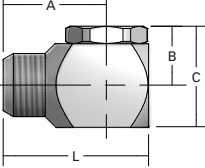
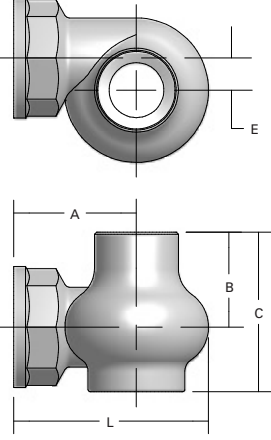
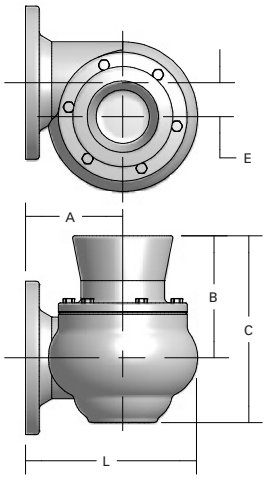

DIMENSIONS AND WEIGHTS

Nozzle	Nozzle Type	Inlet Conn. (in.)	L (mm)	A (mm)	B (mm)	C (mm)	E (mm)	Net Weight (kg)
	AX (F)	1/8	25.4	17.5	11.9	19.8	–	.04
		1/4	31.8	22.2	13.5	23.0	–	.08
		3/8	37.3	26.2	17.5	28.6	–	.12
		1/2	49.2	34.9	21.4	39.8	–	.25
		3/4	55.6	34.9	39.7	31.8	–	.31
	BX (M)	1/8	30.2	22.2	16.6	34.9	–	.04
		1/4	34.9	25.4	13.5	39.7	–	.07
		3/8	39.7	28.6	17.5	39.7	–	.11
		1/2	49.2	34.9	21.4	49.2	–	.20
		3/4	57.2	41.3	39.7	31.8	–	.30
	CX (F)	1	66.7	44.5	31.8	46.8	8.7	.31
		1-1/4	77.8	52.4	33.3	55.6	11.1	.57
		1-1/2	93.7	61.9	38.1	73.0	14.3	.79
		2	115.1	93.7	53.6	93.7	18.3	1.36
		2-1/2	140.5	88.9	68.0	114.3	11.9	1.93
	CF (Flange)	4	209.6	111.9	235.0	314.3	39.7	51.71
		6	311.2	174.6	220.7	338.1	61.9	57.15

Based on the largest/heaviest version of each type.

DIMENSIONS AND WEIGHTS

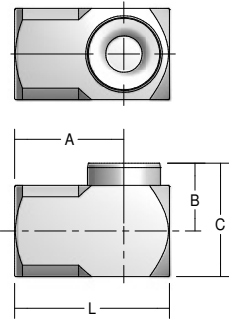
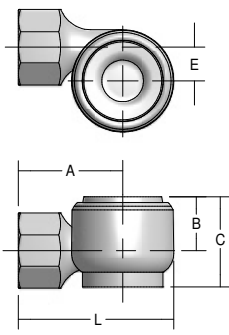
Nozzle	Nozzle Type	Inlet Conn. (in.)	L (mm)	A (mm)	B (mm)	C (mm)	E (mm)	Net Weight (kg)
	E (F)	1/4	31.8	22.2	12.7	19.1	–	.06
		3/8	50.8	34.9	15.9	31.8	–	.30
		1/2	60.3	41.3	19.4	41.3	–	.49
	E (F) Cast	3/8	35.7	31.0	15.1	27.0	9.5	.12
		1/2	55.6	36.5	17.5	31.8	12.7	.17

Based on the largest/heaviest version of each type.

METRIC UNITS



PERFORMANCE DATA
BD WHIRLJET® NOZZLES

Inlet Conn. (in.)	Nozzle Type BD	Capacity Size	Inlet Dia. Nom. (mm)	Orifice Dia. Nom. (mm)	Flow Rate Capacity (liters per minute)												Spray Angle (°)		
					.2 bar	.4 bar	.5 bar	.7 bar	1 bar	1.5 bar	2 bar	3 bar	4 bar	6 bar	7 bar	.5 bar	1.5 bar	6 bar	
3/8	●	2	2.4	2.0	.41	.58	.64	.76	.91	1.1	1.3	1.6	1.8	2.2	2.4	51	60	70	
	●	3	2.4	2.4	.61	.86	.97	1.1	1.4	1.7	1.9	2.4	2.7	3.4	3.6	52	64	77	
	●	5	2.8	3.2	1.0	1.4	1.6	1.9	2.3	2.8	3.2	3.9	4.6	5.6	6.0	56	67	76	
	●	8	4.0	4.0	1.6	2.3	2.6	3.1	3.6	4.5	5.2	6.3	7.3	8.9	9.6	56	65	70	
	●	10	4.0	4.4	2.0	2.9	3.2	3.8	4.6	5.6	6.4	7.9	9.1	11.2	12.1	55	65	72	
	●	20-10	4.0*	4.4	—	4.0	4.5	5.3	6.4	7.8	9.0	11.1	12.8	15.6	16.9	61	65	67	
1/2	●	5	3.2	3.6	1.0	1.4	1.6	1.9	2.3	2.8	3.2	3.9	4.6	5.6	6.0	63	73	79	
	●	8	4.0	4.0	1.6	2.3	2.6	3.1	3.6	4.5	5.2	6.3	7.3	8.9	9.6	61	69	73	
	●	10	4.4	4.4	2.0	2.9	3.2	3.8	4.6	5.6	6.4	7.9	9.1	11.2	12.1	63	70	74	
	●	15	4.4*	5.2	3.1	4.3	4.8	5.7	6.8	8.4	9.7	11.8	13.7	16.8	18.1	60	67	70	
	●	20	4.8*	6.0	4.1	5.8	6.4	7.6	9.1	11.2	12.9	15.8	18.2	22	24	63	65	69	
	●	25	5.2*	7.1	5.1	7.2	8.1	9.5	11.4	14.0	16.1	19.7	23	28	30	59	63	68	
3/4	●	5	3.6	3.2	1.0	1.4	1.6	1.9	2.3	2.8	3.2	3.9	4.6	5.6	6.0	64	73	79	
	●	8	4.4	4.0	1.6	2.3	2.6	3.1	3.6	4.5	5.2	6.3	7.3	8.9	9.6	62	70	74	
	●	10	5.2	4.4	2.0	2.9	3.2	3.8	4.6	5.6	6.4	7.9	9.1	11.2	12.1	64	72	75	
	●	15	6.4	5.6	3.1	4.3	4.8	5.7	6.8	8.4	9.7	11.8	13.7	16.8	18.1	64	72	74	
	●	20	7.1	6.4	4.1	5.8	6.4	7.6	9.1	11.2	12.9	15.8	18.2	22	24	63	70	74	
	●	25	7.1	7.5	5.1	7.2	8.1	9.5	11.4	14.0	16.1	19.7	23	28	30	63	70	74	
	●	50-50.3	7.1*	9.5	10.2	13.3	16.1	19.1	23	28	32	39	46	56	60	70	72	73	
1-1/2	●	40	9.5*	7.9	8.2	11.5	12.9	15.3	18.2	22	26	32	36	45	48	70	73	74	
	●	50	9.5*	9.5	10.2	13.3	16.1	19.1	23	28	32	39	46	56	60	72	75	77	
	●	60	9.5*	11.1	12.2	17.3	19.3	23	27	34	39	47	55	67	72	74	76	79	
	●	70	9.5*	12.7	14.3	20	23	27	32	39	45	55	64	78	84	76	79	83	
	●	80	9.5*	14.3	16.3	23	26	31	36	45	52	63	73	89	96	78	82	84	
	●	90	9.5*	14.7	18.3	26	29	34	41	50	58	71	82	101	109	81	84	84	
	●	100	9.5*	15.9	20	29	32	38	46	56	64	79	91	112	121	83	86	86	
	●	110	9.5*	17.1	22	32	35	42	50	61	71	87	100	123	133	85	88	88	
	●	120	9.5*	18.3	24	35	39	46	55	67	77	95	109	134	145	87	90	90	

*Dual inlets, each in diameter specified.
Highlighted column shows the rated pressure.

DIMENSIONS AND WEIGHTS

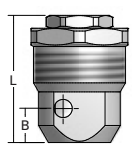
Nozzle	Nozzle Type	Inlet Conn. (in.)	L (mm)	Hex. (in.)	B (mm)	Net Weight (kg)
	BD (M)	3/8	31.8	11/16	6.7	.03
		1/2	37.3	7/8	8.0	.06
		3/4	44.5	1-1/16	9.5	.11
		1-1/2	66.7	2	8.0	.60

Based on the largest/heaviest version of each type.



**PERFORMANCE DATA
BSJ SPIRALJET® NOZZLES**

Inlet Conn. (in.)	Nozzle Type	Spray Angle at .7 bar					Capacity Size	Orifice Dia. Nom. (mm)	Max. Free Passage Dia. (mm)	Flow Rate Capacity (liters per minute)					
		BSJ	50°	60°	90°	120°				180°	.4 bar	.7 bar	1.5 bar	3 bar	7 bar
1/4	●	●	●	●	●	●	07	2.4	2.4	2.0	2.7	3.9	5.5	8.4	16.0
	●	●	●	●	●	●	13	3.2	3.2	3.7	5.0	7.3	10.3	15.7	30
	●	●	●	●	●	●	20	4.0	3.2	5.8	7.6	11.2	15.8	24	46
3/8	●	●	●	●	●	●	30	4.8	3.2	8.6	11.4	16.8	24	36	68
	●	●	●	●	●	●	40	5.6	3.2	11.5	15.3	22	32	48	91
	●	●	●	●	●	●	53	6.4	3.2	15.3	20	30	42	64	121
	●	●	●	●	●	●	82	7.9	3.2	24	31	46	65	99	187
1/2	●	●	●	●	●	●	120	9.5	4.8	35	46	67	95	145	274
	●	●	●	●	●	●	164	11.1	4.8	47	63	92	129	198	374
3/4	●	●	●	●	●	●	210	12.7	4.8	61	80	117	166	253	479
1	●	●	●	●	●	●	340	15.9	6.4	98	130	190	268	410	775
	●	●	●	●	●	●	470	19.1	6.4	136	179	262	371	567	1071
1-1/2	●	●	●	●	●	●	640	22.2	7.9	185	244	357	505	772	1459
	●	●	●	●	●	●	820	25.4	7.9	236	313	458	647	989	1869
	●	●	●	●	●	●	960	28.6	7.9	277	366	536	758	1158	2188
2	●	●	●	●	●	●	1400	34.9	11.1	404	534	782	1105	1689	3191
	●	●	●	●	●	●	1780	38.1	11.1	513	679	994	1406	2147	4057
3	●	●	●	●	●	●	2560	44.5	14.3	738	976	1429	2021	3088	5835
	●	●	●	●	●	●	3360	50.8	14.3	969	1282	1876	2653	4053	7659
4	●	●	●	●	●	●	5250	63.5	15.9	1514	2002	2931	4145	6332	11967

Maximum Free Passage Diameter is the maximum diameter as listed of foreign matter that can pass through the nozzle without clogging. For all 1/4" and 3/8" connections, optimum spray angle is achieved at 40 psi (2.8 bar).
*Maximum operating pressure depends on material, size and application. Contact your local sales engineer for specific recommendations. Highlighted column shows the rated pressure.

DIMENSIONS AND WEIGHTS

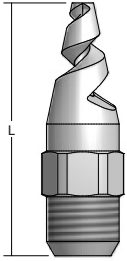
Nozzle	Nozzle Type	Inlet Conn. (in.)	L (mm)	Hex. / flats (in.)	Net Weight (kg)
	BSJ (M)	1/4	49.2	9/16	.03
		3/8	47.6	11/16	.05
		1/2	63.5	7/8	.09
		3/4	69.9	1-1/16	.14
		1	92.1	1-3/8	.31
		1-1/2	111.1	2	.77
		2	174.6	2-1/2	1.36
		3	203.2	3-3/4	3.63
4	228.6	4-1/2	5.67		

Based on the largest/heaviest version of each type.

