

AutoJet[®] 1750+ Spray Control Panel

OWNER'S MANUAL

AutoJet[®]
TECHNOLOGIES



Spraying Systems Co.[®]
Experts in Spray Technology

ML001750PLUS
spray.com

TABLE OF CONTENTS

1. Preface	3	12. Trigger devices and Accessories	36
1.1 Important	3	12.1 Electric Nozzle Cord Set	36
1.2 How To Use This Manual	3	12.2 Trigger Cable	36
2. Safety	3	12.3 Photoelectric Object Sensor	37
2.1 General Safety Information	3	12.4 Color Sensor	37
2.2 Unpacking The System	4	12.5 Proximity Sensor	38
3. 1750+ Overview	5	12.6 Trigger Interlock	38
3.1 Features	5	12.7 Foot Switch	38
3.2 Specifications	5	12.8 Hand Trigger Pendant	39
3.3 Plug and Spray Connections	7	12.9 Thru-Beam Sensor	39
3.4 Remote Connections	8	12.10 Laser Sensor (Short)	40
3.5 Screen Buttons and Icons	8	12.11 Laser Sensor (Long)	40
3.6 HMI Operation—Set Spray Parameters	9	12.12 Alarm Output Signal	40
3.7 Activating Recipes	9	12.13 Alarm Output Cable Kit	41
4. 1750+ Home Screen Settings	10	12.14 Extension Cable	42
4.1 Home Screen Settings	10	12.15 Input Signal	42
4.2 Purge and Clean Settings	10	12.16 Level Sensor Input	43
5. General Settings	11	12.17 Trigger Devices Overview	43
5.1 Settings Screen	11	13. Spare and Replacement Parts	44
5.2 Users Management Settings	12		
5.3 User Groups	14		
6. Supply Air To The System	15		
6.1 Adjustments and Operations	15		
7. Application Settings	16		
7.1 Spray Nozzle Settings	16		
7.2 Recipe Settings	20		
7.3 Spray Timing Modes	21		
7.4 Fixed Spray Time	22		
7.5 Variable Spray Time	24		
7.6 Duty Cycle	27		
7.7 Trigger	28		
7.8 Tank Level (Level Sensor)	29		
8. Alarms	30		
8.1 Alarms	30		
9. Maintenance and Troubleshooting	31		
9.1 Maintenance and Troubleshooting Tab	31		
10. Diagnostics	33		
11. Alarms and Troubleshooting	33		

PREFACE

1.1 IMPORTANT

This AutoJet[®] Spray Control Panel and all components are produced, tested and checked at the factory. The system can be dangerous if used incorrectly. Read this manual carefully and read all safety instructions.

Operators must always follow the general safety instructions in the working area and aim to prevent accidents.

The manufacturer reserves the right to make changes in standard construction without prior notification.

Images and diagrams in this manual may not be exact representations of your system configuration.

1.2 HOW TO USE THIS MANUAL

This manual is intended to be a source of information for the operators and/or technicians who may be installing, interacting with, or servicing/maintaining Spraying Systems Co.[®] systems and components.

This manual contains important safety warnings, installation/operating instructions, and troubleshooting/maintenance information.

ICONS



WARNING: The user can be seriously injured, damage their health, and/or damage the system.



CAUTION: Product, process, or environment can be damaged or be in danger if the instructions are not followed correctly.



ATTENTION: Supplementary information for the user that draws attention to possible problems.

SECTION 2

SAFETY

2.1 GENERAL SAFETY INFORMATION

READ AND FOLLOW INSTRUCTIONS

All safety related and operating instructions should be read before the system is operated. Follow all operating instructions.

SERVICING

Do not attempt to service this system unless you have been trained or authorized to conduct repairs. Only authorized and qualified service personnel should attempt to service this system. Service by unauthorized personnel will void any warranties.



WARNING: Before performing any maintenance, make sure electrical power is off and that any air and liquid pressure is bled from the system.

REPLACEMENT PARTS

This system has been designed with components that work together to provide the best system performance. When replacement parts are required, only Spraying Systems Co.[®] recommended components should be used to maintain proper system operation, electrical and pneumatic safety. The use of any unauthorized replacement parts will void any warranties.

UNINTENDED USE

Use of Spraying Systems Co.[®] equipment in ways other than those described in the documentation supplied with the equipment may result in injury to persons or damage to property. Examples of unintended use of equipment:

- Using incompatible materials
- Making unauthorized modifications
- Removing or bypassing safety guards or interlocks
- Using incompatible or damaged parts
- Using unapproved auxiliary equipment
- Operating equipment in excess of maximum ratings

REGULATIONS AND APPROVALS

Make sure all equipment is rated and approved for the environment in which it is used. Any approvals obtained for Spraying Systems Co. equipment will be voided if instructions for installation, operation, and service are not followed. All phases of equipment installation must comply with federal, state, and local codes.

PERSONAL PROTECTIVE EQUIPMENT

Spraying Systems Co. strongly recommends the use of appropriate safety equipment when working in potentially hazardous environments and chemicals. This safety equipment includes, but is not limited to, the following:

- Protective hat
- Safety glasses or face shield
- Chemical-resistant or safety gloves and apron
- Long sleeve shirt and long pants

Users of this product should never place themselves in the path of the resulting spray. Users should consult and follow the recommendations of the Safety Data Sheet (SDS) of any chemical or fluid sprayed using this system.

PRESSURIZED SYSTEMS

It is important to recognize proper safety precautions when using a pressurized spray system. When dealing with pressure applications, the system pressure should never exceed the lowest rated component. Always know your system, all component capabilities, maximum pressures, and flow rates.



WARNING: Fluids under pressure can penetrate skin and cause severe injury.



ATTENTION: Always remember to carefully read the chemical manufacturer's labels, follow SDS and all directions.

WARNING OF SHOCK HAZARD

To reduce the risk of electric shock, do not open the cover on electrical control panel. For service contact Spraying Systems Co.® at 1-866-321-2250.



WARNING: Plug panels into a GFCI outlet.



WARNING: To prevent injury, avoid contact with potentially hot parts. Components can cause severe burns. Do not aim the spray at any person or part of the body. Do not place any part of your body in the spray pattern.

2.2 UNPACKING THE SYSTEM

The system components come carefully packaged to protect them from damage. Use caution when opening the crate. The crate will contain all parts needed to install the unit. Parts of the unit may be wrapped in bubble wrap. Remove all of the packaging material wrapping the system. Once unpacked and removed from the crate, the system is ready for installation and connection.



CAUTION: The packaging may contain exposed cables, hoses, or other components. Always exercise caution when opening boxes to avoid accidental damage or slicing of various components.

1750+ OVERVIEW

The AutoJet® 1750+ Spray Control System featuring an HMI Touch Screen Display is a self-contained, electronic/pneumatic panel that provides control of various aspects of a spray system. These systems come in a variety of design configurations depending on the requirements of your spray application, therefore, you may or may not have all the features described in this owner's manual.

3.1 FEATURES

The Spraying Systems Co.® AutoJet 1750+ Spray Control System is a self-contained unit that can provide you with precise liquid delivery and spray nozzle control in an affordable easy to use turn-key spray system. The system comes in a variety of designs and configurations based on the type of spray nozzle used in your application.

The system can be used with water, oils, lubricants, inks, stains, water-based solvents, and non-abrasive slurries. The system is designed to spray most non-flammable or non-volatile materials. Liquids and materials that flow with viscosities below 1000 cP at 68°F (20°C) can be sprayed with the correct spray nozzle and controlled with this unique spray system solution.

SYSTEM USAGE

- The AutoJet 1750+ Spray Control System is designed to run continuously or intermittently.
- The AutoJet 1750+ Spray Control System features a high-quality HMI touchscreen interface.
 - The user can set and control different spray timing such as; spray period, start delay, and stop delay times.
- The controller is designed to run both electric and air actuated spray nozzles.
 - Can drive Spraying Systems Co. electric-actuated spray nozzles (3.6 amps. max.) with Pulse Width Modulation (PWM). Specifically, the PalsaJet® spray nozzle line and the AA250AUH Electric spray nozzles can be used.
 - PWM (Pulse Width Modulation) is a technique used to control flow rate by rapidly pulsing the nozzle on and off and uses a duty cycle within the spray time. Duty Cycle (DC) is the percent of time of the total cycle time the nozzle is spraying. If the nozzle is spraying 50% of the time, the DC is 50% thus the flow is ½ that of the nozzle being fully open.

3.2 SPECIFICATIONS

- 4.3" HMI Touch Screen display unit featuring custom programming.
- UL Type 1, stainless steel control panel.
- Stainless steel enclosure, wash-down with door closed, not explosion proof (Non-Ex).
- Power ON/OFF switch with Power on LED indicator light.
- Power input 110-230VAC, 50/60, 1 ph., 2.2A (Plug into a GFCI outlet).
- Global compatibility Multi-voltage power cords available
- Power cord, 6 ft. (2m) length.
- Output 24 Vdc
- 3.6 amps dedicated to electric spray nozzles and sensors
- Wireless access point.
- Inputs for 1 analog input, 3 digital inputs and 3 digital outputs.
- Includes digital output for air atomizing solenoids.
- Offers dual digital inputs for conveyor interlock type trigger.
- Features local and remote triggering options.
- Independent timing ranges for spray and delay adjustable from 0 to 20,000 seconds.
- Delays for atomizing air (anticipator and follower times) can be set 0 to 10 seconds.

- 1 – 100% duty cycle adjustment for PulsaJet and other electric spray nozzles.
- Offers easy to use timing modes of Fixed Spray Time; Variable Spray Time, and Repeat.
- Can control and drive up to ten (10) Spraying Systems Co.® electric spray nozzles
- AA10000AUH-03 PulsaJet® spray nozzles – Ten (10)
- AA10000JAU PulsaJet air atomizing spray nozzles – Ten (10)
- AA10000AUH-10 PulsaJet spray nozzles – Three (3)
- AA10000AUH-30 PulsaJet spray nozzles – One (1)
- AA250AUH Electric spray nozzles – Ten (10)
- Ambient temperature ratings for electric control panel:
- 41°F Minimum (5°C)
- 104°F Maximum (40°C)
- Dimensions: 9" (228.6 mm) x 4 1/4" (108 mm) x 10 1/2" (266.7 mm)

For International applications be sure that you have the correct power cord.

FUSE			
FUSE ID	AMPS	VOLTAGE	TYPE
FU2200	5	120	MDA

PRECISION SPRAY CONTROL (PSC)

The PulsaJet® automatic spray nozzle is an electrically-activated hydraulic, atomizing nozzle. This nozzle sprays the product in a controlled way using a PWM algorithm to control the sprayed amount without affecting the spray angle. PWM is the fundamental control principle that allows a significant reduction in flow by regulating the relationship between the on/off times that the nozzle operates.

Short pulses of on-time and longer pulses of off-time produce a spray pattern that appears continuous, but actually reduces the overall flow delivered to the target surface. This provides better flow control with larger spray tips that are less prone to clogging. The droplet size is affected by the pressure of the liquid. With PSC, the droplet size and spray angle are independent of the liquid flow because the nozzle can work at the same liquid pressure for variable liquid flows.

PSC involves switching the spray nozzle on and off repeatedly at a controlled rate, called the modulating frequency. The modulating frequency is the number of times the nozzle is switched on and off in one second and is measured in Hertz (Hz). If a spray nozzle is switched on and off 10 times per second, the modulating frequency is 10 Hz. The time from when the nozzle turns on to the next time the nozzle turns on is called the period, in this case 1/10th of a second.

Within a single period, the nozzle is switched on, then off. The time that the nozzle is on, divided by the total time of the period, gives a percentage which is called the duty cycle. For example, if the period is 0.10 seconds, and the nozzle is on for half of that time, then the duty cycle is 50%. For the same period, if the nozzle is on for 0.08 seconds then the duty cycle is 80%. Therefore, at an 80% duty cycle, the flow will theoretically be 80% of the maximum flow rate (= 100% flow rate) at a given pressure for the nozzle. Using PSC, the flow rate for a spray application can be easily controlled without the need to adjust the spray pressure or spray tip.

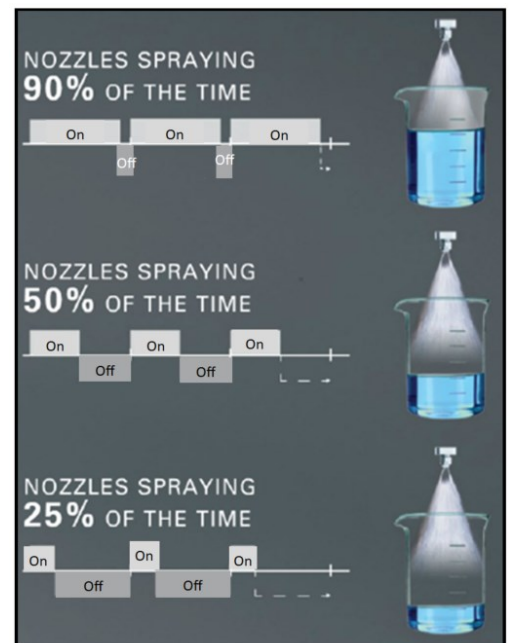

3.3 PLUG AND SPRAY CONNECTIONS

All the connections are the same as the full system. Located on the bottom of the panel the connections are as follows.

- Power input connection, route power cord through oval opening on right-hand side of frame and plug in 120 VAC outlet rated for at least 5A.
- **4-20 mA** - Remote Duty Cycle Input. Analog input is accessible through this connection.
- **Main** - Nozzle Liquid ON/OFF connection. Use this output for the connection on all electric spray nozzles and cylinder air.
- **Trig** - Is the input connection for the system trigger or sensor. Connect cable to Trig connection that will be used to start spray sequence. Available triggers are as follows, the one used should be based on the customer's application.
 - Trigger cable (for use with customer-supplied trigger signal)
 - Sensors including: object, proximity, laser (short/long), thru-beam, and full spectrum color sensor.
 - Hand-held trigger unit
 - Foot switch
- **Aux** - Nozzle air ON/OFF for fan and atomizing air control.
- **T. int.** - Used for the optional trigger interlock or level switch input. Trigger Interlock controls the state of run/standby mode.



PLUG AND SPRAY COMPATIBILITY

The 1750+ can be mounted to the universal frame with mobile cart. Plug and Spray provides quick hook up for all nozzles, an Air Control Package (ACP), triggers, and any other compatible SCS Series accessories including a level switch, an interlock cable, and the remote setpoint cable. Plug into GFCI outlets.

POSITION OR MOUNT THE SYSTEM

Find a convenient location for the 1750+ AutoJet[®] Spray Control System within a reasonable distance of your spray application and easily accessible to a properly grounded power outlet. The unit must be installed when the cord is connected, the plug can be easily reached and easy to remove from the outlet.

- Determine if the unit will be free-standing or wall mounted.

CONTROL PANEL ONLY VERSION

If you have the Control Panel Only version the unit should be wall mounted.

Install wall anchors that are designed to support at least 25 lbs., according to the anchor manufacturers' specifications. The mounting holes are on 5 7/16" (138 mm) centers and are made for 1/4" (6 mm) screws with 3/8" (10 mm) diameter screw heads. Secure the Model 1750+ to its selected location.

3.4 REMOTE CONNECTION

Users can connect to the 1750+ with a mobile device via Wi-Fi to create an access point. Once set-up is complete, you can adjust settings, view alarms, troubleshoot, review maintenance schedules, and more on the connected mobile device. The 1750+ Preventative Maintenance (PM) scheduler allows the user to set various maintenance reminders by months or number of cycles. An alarm will appear on the HMI when the maintenance is due.

SMART DEVICE CONNECTION SET-UP

1. Go to the Play Store or Apple App store and download a VNC viewer app, such as RealVNC Viewer.
2. Power on the 1750+ (if system is not already on).
3. In Wi-Fi settings on your mobile device, locate the Wi-Fi SSID: SSCO_PJNXXXX (each project number will be specific per device and given to owner). Select connect and enter the default password of SSCO_SCS.
4. Open VNC Viewer and connect to the 1750+ at: 192.168.0.20

Note: There is a chance that your network administrator blocks this type of connection.

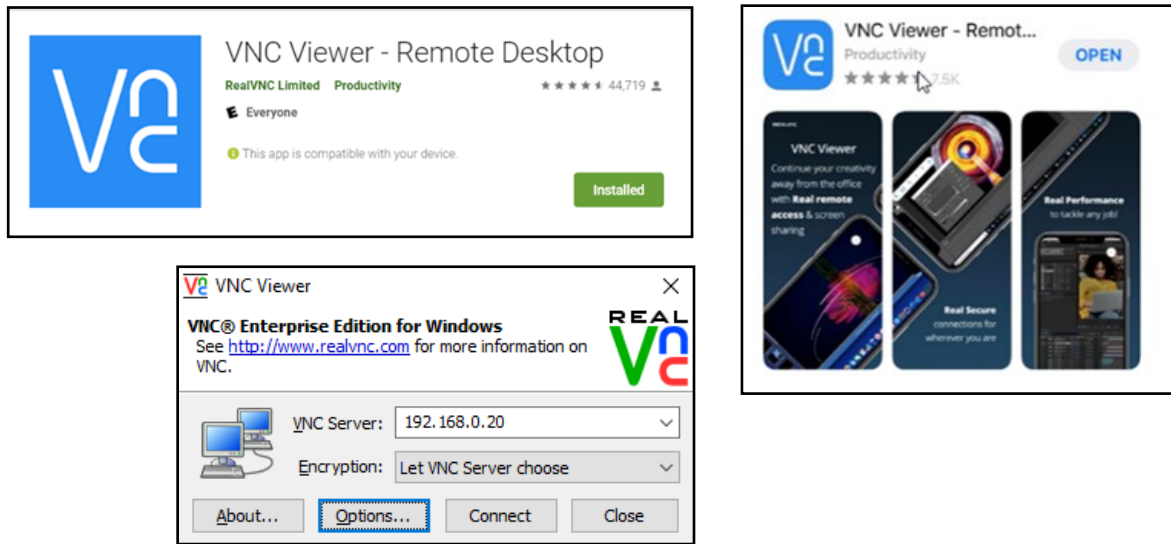

3.5 SCREEN BUTTONS AND ICONS

Top Bar Status Information	
	Navigate to about screen.
	Recipes
	Displays current system status.
	Reset Alarm

Screen Buttons	
	Field is editable
	Toggled On
	Toggled Off
	Standby or Run
	Trigger

Side Bar Navigation	
	Navigate to home screen.
	Navigate to settings screen.
	Navigate to diagnostics screen
	Navigate to alarms screen, turns orange with an active alarm present.
	Switch to a different user.

3.6 HMI OPERATION—SET SPRAY PARAMETERS

1. Set the system to manual mode. Disconnect the nozzles. Set all pressure regulators to 0. Turn on the main air pressure and increase liquid pressure gradually to flush the system. Everything is now flushed except for the nozzles.
2. Connect the nozzles and set the pressure regulators to the required pressure and then check if there are any leakage.
3. If the nozzle type isn't set, go to the *Spray Nozzle Settings* section of this manual.

STARTING THE SYSTEM

1. Verify the system status is in "Run" mode. (top bar, right corner)
2. If not, press "run" button until the system is in "RUN" mode.
3. Be sure a recipe is selected. If you have purchased the optional software upgrade and the desired PWM setpoint is set in the recipe (between 1% and 100% depending on your application).

3.7 ACTIVATING RECIPES

A recipe is a pre-configured set of parameters that allows you to change to a different production batch quickly. These parameters cover most of the timing and spray settings.

By default, your new 1750+ control panel has simple timing to operate your PulaJet electric spray nozzles. As an optional item, you can unlock the recipe function on your new 1750+ controller which allow you to setup and save different ways to spray each batch.

If you purchase the recipes functionality at a later date, you will receive an unlock code that you can enter directly into the 1750+. You access this by clicking on the settings icon/users, then click in the space shown below and it will ask for the code. Enter the code and recipes will be unlocked.

A recipe can be loaded by selecting it from the dropdown menu and clicking "Apply" to transfer the settings to the 1750+. If you edit the currently selected recipe, you must press "Apply" again for the changes to be applied.

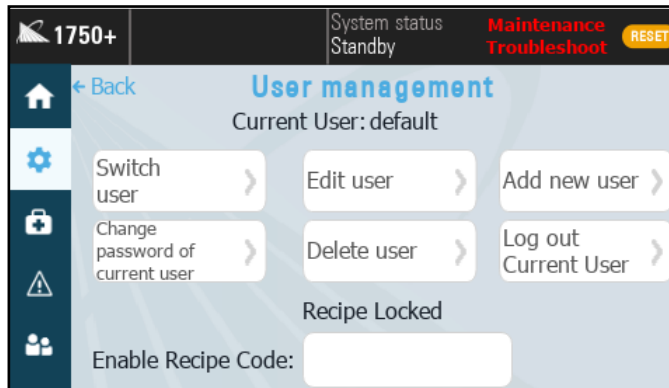

Enter recipe code in the box at the bottom of the screen.

RECIPES

Preprogrammed recipes can be accessed quickly from any screen by selecting the recipe section of the top bar.

The recipe settings sections contains four tabs. The drop down list near the top of the page allows you to select which recipe you would like to view, edit, or apply as the current spray parameters. The 1750+ is capable of storing up to 20 user-created recipes.

1750+ HOME SCREEN

4.1 HOME SCREEN SETTINGS

The home screen at the top and side bars will always be visible and accessible.

Setpoint: Displays the configurable mode in the application you are set in.

Nozzle status: Displays the current nozzle spray status as a percentage of the maximum flow rate.

Atomizing air status: Atomizing Air Status and spray status are read-only representations of the current status. Adjust atomizing air in settings, and toggle the spray status by using the run or trigger buttons.

Spray status: Shows whether the nozzle is currently spraying or not.

Clean/Purge: Access or trigger the clean and purge cycle settings.

STANDBY/RUN

Using this Toggle button, you can swap between Run and Standby states.

- Run: The system will spray if it is triggered.
- Standby: The system will stop spraying and will not react to a new trigger signal.

If the system is busy spraying, it will finish the “follower” for the air output to cleanly stop spraying.

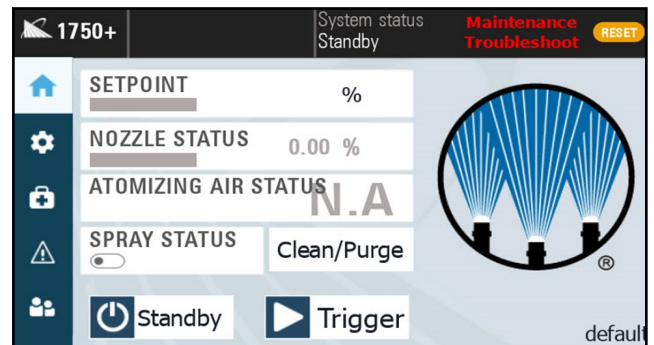

1750+ Home Screen

TRIGGER

The trigger button is only shown if the trigger source has been set to “Button on home screen” in “Trigger settings”.

Depending on your settings, you will have:

- Fixed spray mode, Momentary button (single shot mode): starts a spray when clicked.
- Variable spray mode, Toggle button: starts & stops a spray when clicked.

4.2 PURGE AND CLEAN SETTINGS

The Purge and Clean cycles can be toggled on or off with their labeled On/Off indicators at the bottom of the screen. A blue indicator with the dot on the right-hand side shows the currently selected and active cycle.

PURGE

The purge cycle is used to empty the fluid lines of liquid, or as an additional way to drain a tank or pressure pot.

The purge cycle automatically sets the nozzle duty cycle to 100% (fully open) and requires the operator to manually turn the cycle on or off using the labeled indicator. The cycle will continue until it is manually turned off. The other values are not editable while the purge cycle is active.

CLEAN

The clean cycle is commonly used to clear a nozzle that appears to be clogged and requires the operator to set three editable values.

These values include:

- Clean Duty Cycle — Set between 1–100%
- Max Cycle Speed — Set between 60–5,000 cycles/minute
- Clean Time — Set between 1–250 seconds

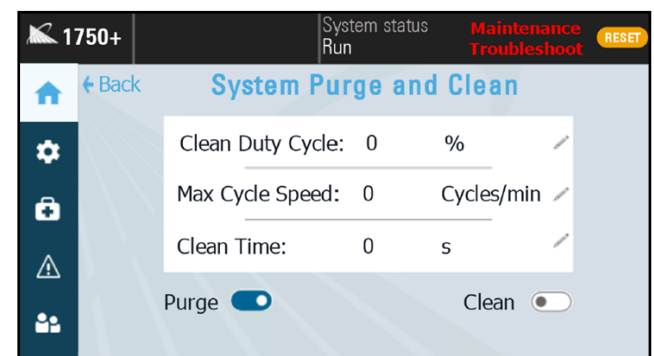

Purge and Clean settings screen

GENERAL SETTINGS

General Settings and Application Settings are the two settings in the 1750+. General settings are related to the spray control panel itself and include settings that relate to operators and interaction with the 1750+.

5.1 SETTINGS SCREEN

The 1750+ allows operators to manage users and user settings, change the language (where applicable), view system information, and view the activity log.

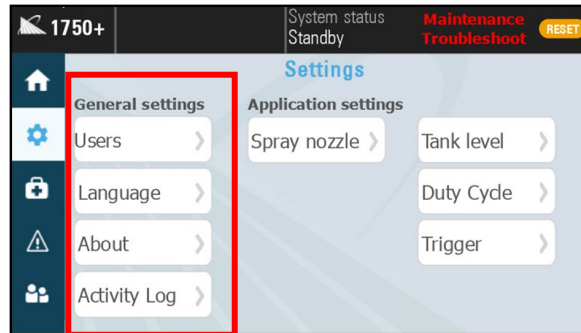

Settings Screen

LANGUAGE

Here you will be able to change the language of the user interface text if available.

ABOUT SCREEN

This screen displays information about your system. You can find the following information in the about screen:

- Spray controller serial number
- Spray controller software version and revision number
- Spray controller/panel uptime
- Current date/time

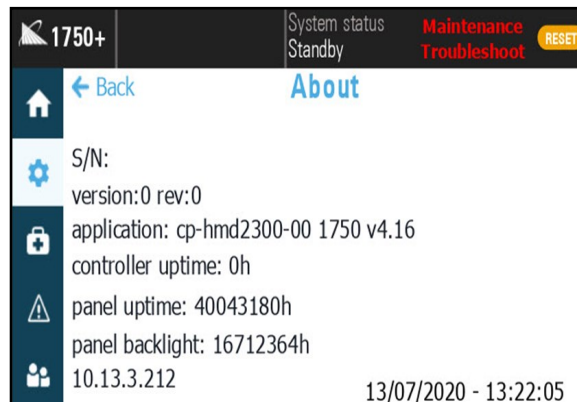

About screen

ACTIVITY LOG

Displays a log of which parameters were changed by which user.

This log is stored locally in the panel but can be deleted or exported to a USB Stick. Used for troubleshooting.

Timestamp	serNam	Operation	Information
12/13/21 - 15:58:20	default	WRITE TAG	0/pwm1 frequency onOff max ti
12/13/21 - 15:58:20	default	WRITE TAG	0/pwm1 frequency onOff max dist
12/13/21 - 15:58:20	default	WRITE TAG	2300/digitalOutput DO1 function;
12/13/21 - 15:58:20	default	WRITE TAG	2300/digitalOutput DO2 function;
12/13/21 - 15:58:20	default	WRITE TAG	a2300/digitalOutput DO1 invert;C
12/13/21 - 15:58:20	default	WRITE TAG	a2300/digitalOutput DO2 invert;C
12/13/21 - 15:58:20	default	WRITE TAG	a2300/digitalOutput DO3 invert;C

Activity Log Screen

5.2 USER MANAGEMENT SETTINGS

The 1750+ allows you to edit or create your own users so that each person who interacts with the system can have their own personal login details. The 1750+ tracks all changes to critical settings and records, which users can make these changes; this information is available in the activity log. Users within the User Group cust_admin can view these activity reports on the 1750+ or export the activity report via a USB stick.

Note: When the system is started for the very first time, and for every reboot thereafter, it boots up to “default” (user) which has admin rights and can edit all settings.

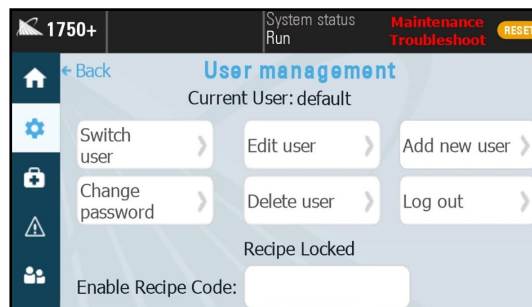

User management screen



ATTENTION: A system restart is required to apply any changes made to user settings.

Note: Should it ever be required, you can contact your Spraying Systems Co.® representative to receive instructions on how to perform a total system reset to factory settings.

Switch User

Sign out the current user by signing in a new user, or sign in a user. This screen will also appear when selecting the users icon on the left-hand menu bar.



Users button

User name: SSCO
Password:
 Show password
Back Sign In

Login or switch user screen

Edit User

Edit the selected user's properties. You can change the user's password for them, or change their User Group.

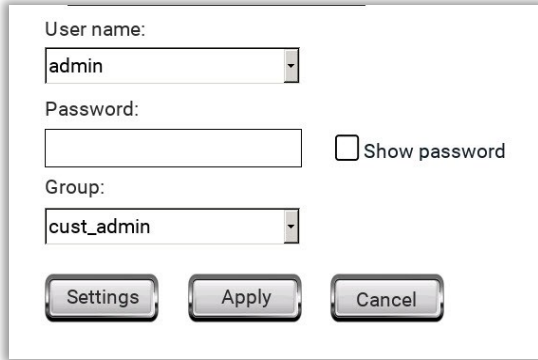

Edit user screen

Add User

Create a new user and assign them to a User Group. Ensure that you use the drop-down menu to pick the correct user group. Select "Add" to add the user to the 1750+ user list.

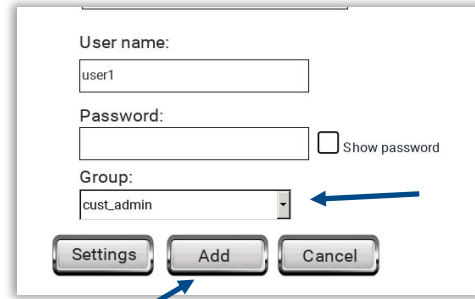

Add user screen

Settings

The Settings option within Add new user gives you additional options.

You can:

- Require the new user to change their initial password on their first login
- Change how long the new user may remain logged in without any activity
- Setting the value to 0 will leave the user logged in until they choose to log out, or the system is rebooted.

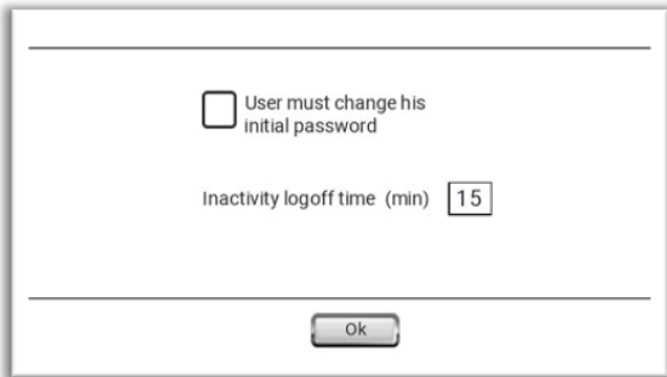

Add new user—settings

Change Password

Allows you to change the password of the user that is currently logged in. Enter the user's current password, and then enter the desired new password. Select "Change" to confirm the action.

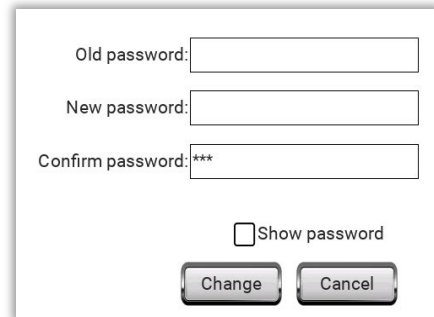

Change password screen

Delete User

This screen allows a created user to be deleted. You must select the username and group of the user you want to delete, then select "Delete" to remove the user.



Delete User Screen

Log Out

Yes or no choice to log out the current user. The 1750+ will return to the "default" user after someone logs out.

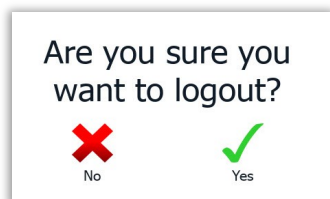

Log out confirmation screen

5.3 USER GROUPS

The system contains four preloaded users (username and password sets) that are the factory (default) settings. Users can choose to use (or edit) these existing users or create new users as they see fit.

Each of these default users has a different level of user rights to interact with the system based on their selected User Group. It is very important to pay close attention to the selected User Group for each current and created user. The table below shows the factory default users, user groups, and user rights. The minimum password length for all user groups is four (4) characters, and all user groups have access to basic spray control panel features.

Factory (Default) User Rights and Settings						
Default Username	Initial Password	User Group	Log Off Time (min)	Advanced Features	Edit/Add Users	Reboots to User
operator	oper	operators	n/a			
default	default	cust_admin	n/a	x	x	x
admin	admin	cust_admin	15	x	x	
SSCO	60189	admin	15	x	x	

USER GROUP:

Operators

These users can trigger the system and put it in standby mode. Operators can change the duty cycle setpoint. All other functions are disabled or read-only for users in the operator user group.

- The factory settings user “operator” is a member of this user group.

Cust_admin

These users have full control over all system settings and can edit or create new users.

- The factory settings user “admin” is a member of this user group.

Admin

There is a fourth factory settings user “SSCO” that is included with the system in User Group admin.

This user is included as a backup option to reset User Group cust_admin passwords if they are lost.

Do not use the “SSCO” user for daily operation of the unit. User Group admin and User Group cust_admin have the exact same access rights.



ATTENTION: A system restart is required to apply any changes made to user settings.

DEFAULT USERNAME:

Initial startup and all reboots of the system will load into the factory settings “default” user profile.

Under factory settings, the user “default” is within the user group default, which has the exact same level of access as user group cust_admin.

- With factory settings, this user has full control over the system and can edit or create new users.
- Users can edit this user to change its access level.
- Can be changed to user group “operator” to remove edit access.
- Can set an Inactivity logoff time to require someone using the system to log in with their personal credentials after a set period of time.



SUPPLY AIR TO THE SYSTEM

6.1 ADJUSTMENTS AND OPERATIONS

1. Turn the red valve on the air inlet valve/regulator/filter clockwise to the on position. Turn regulator that is on top of the air filter to an air pressure between 40-100 psi (2.8-6.9 bar). Air pressures higher than this will shorten the life of the pump.
2. Adjust the regulated air pressures (regulators on front panel).
 - If applicable, depending on your spray system you may have anywhere from Liquid Pressure regulation only to Liquid Pressure; Pump Air (preset); Atomizing Air (drop size); Fan Air (spray angle/pattern).
3. Each air control line is equipped with a manual air pressure regulator. The regulators can be adjusted by first pulling up on the knob to unlock the regulator and then turning clockwise to increase and counterclockwise to decrease the pressure.
4. When the proper air pressure is reached, press down on the knob on the regulator to lock it in place.

Note: Your system is equipped with cylinder air for air actuated spray nozzles. Cylinder air pressure is equal to the inlet air pressure to the system. It is not regulated; therefore, you must provide a minimum of 45 psi (3.1 bar) to the system. It must be above 45 psi (3.1 bar) to actuate air actuated nozzles like Spraying Systems Co.® 1/4JAU series.

5. Adjust the Liquid Pressure regulator. For pump version ensure that the pump inlet air valve is in the “open” position. The regulator can be adjusted by first pulling up on the knob and then turning clockwise to increase and counterclockwise to decrease the pressure. When the proper liquid pressure is reached, press down on the knob to lock it in place.

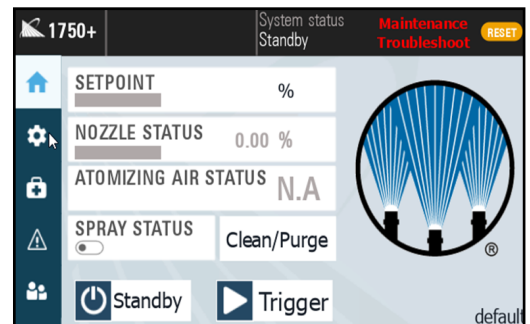

Color Code: Aux		
Pin #	Color	Description
1	Brown	+24 VDC
2	white	N/A
3	Blue	Air Output
4	Black	N/A

Air Connection Specifications

SECTION 7 APPLICATION SETTINGS

Application settings are related to your spray application, and will allow you to customize the spray parameters to achieve the desired spray coverage and flow rates. These settings will also allow you to configure certain 1750+ accessories, such as the trigger interlock and remote duty cycle if they are included in your specific configuration in later chapters of the text. This Application Settings section explains the Spray Nozzle Settings, Configuration, Duty Cycle, Trigger, and Tank Level Sensor Settings.

Note: Application Settings and Recipe Settings are the same. Use recipe function to configure most settings if the recipe feature is included in your system configuration.

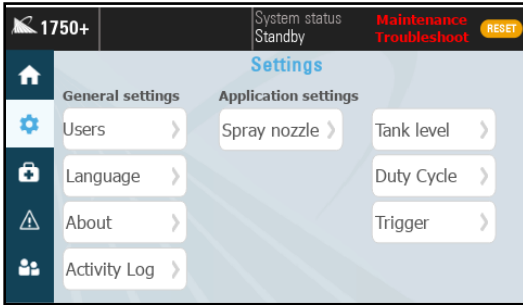

Application Settings

Color Code: Main		
Pin #	Color	Description
1	Brown	PWM +
2	white	Fault
3	Blue	PWM -
4	Black	N/A

Main Connection Specifications

7.1 SPRAY NOZZLE SETTINGS

The Nozzle Settings page allows for the editing of the Nozzle type and Cycle Speed.

- Nozzle type: nozzle family selection, atomizing air selection, and anticipator/ follower time.
- Cycle speed: allows for the editing of the minimum and maximum cycles per minute.

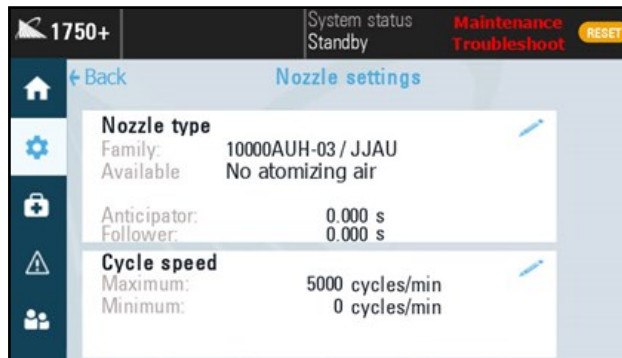

Nozzle Settings Screen

SELECTING NOZZLE TYPE:

- Nozzle Family: Select the type of nozzle supplied with your system.
- Enable Atomizing Air if your system requires air atomizing.
- Advanced Nozzle Settings allows for editing the PWM settings.

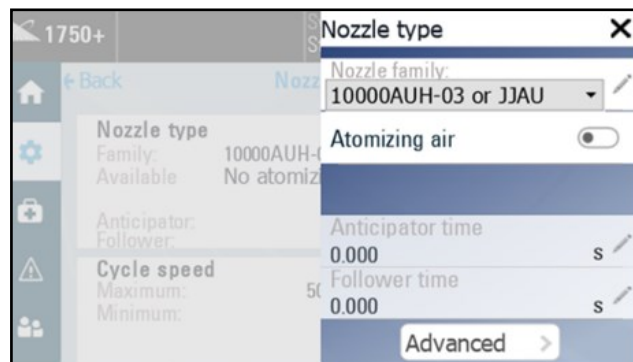

Editing Nozzle Type

DISTANCE BASED SPRAY TIMING

The fixed and variable spray length timing modes have an alternative in which distances are used instead of time. These modes are called *fixed spray distance* and *variable spray distance*. In these modes, delays are expressed in distance units. These are the units that were chosen when calibrating the frequency input.

The anticipator time in this mode has a special behavior, it is converted to a distance using the maximum speed, meaning that it is a minimum anticipator time. At speeds below the maximum speed, it will be longer.

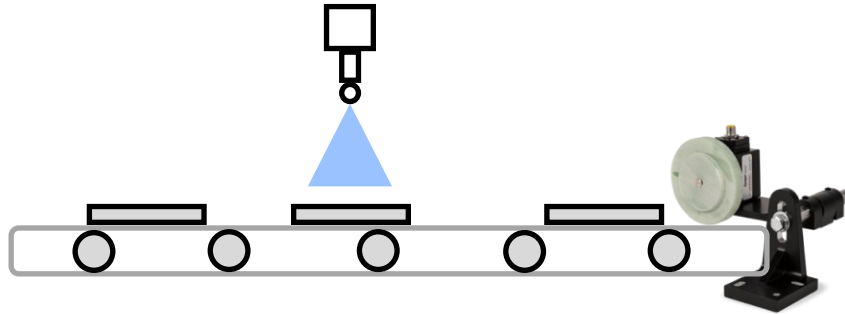

ANTICIPATOR/FOLLOWER TIME

The system will start spraying when it receives a “trigger” signal and stop when the trigger signal is removed.

If your system is equipped with an air atomizing nozzle the 1750+ will switch the air output on before it starts spraying to allow the spray pattern to develop fully. When the system stops spraying, the air will continue for a short period after to guarantee no large droplets can drip off of the nozzle. These times always reference from the spray timing. Max time for both is 10 s.

Note: The anticipator time must not be shorter than the start delay time set in the timing settings.

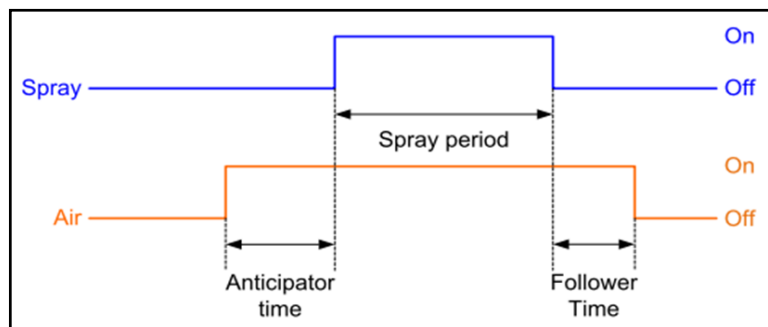

Anticipator-Follower

When a spray pattern is generated where the off time < (anticipator time + follower time), the air output remains on for the duration of this pattern.

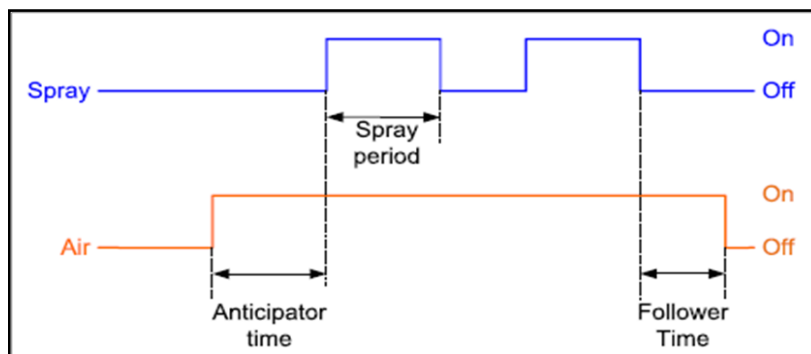

Overlapping anticipator / follower sequence

PARAMETERS—ADVANCED NOZZLE SETTINGS

For custom applications, it is possible to change the properties of the nozzle manually. These settings should only be modified by instruction from qualified SSCO personnel except for the nozzle cycle count.



WARNING: Incorrect settings can permanently damage the spray nozzle!

Negative Pulse: Pulse time in milliseconds

- Used to speed up the closing of the electric spray nozzle, duration is dependent on nozzle model and supply voltage.

Gun (Nozzle) Offset: Offset time in milliseconds

- The difference in the opening and closing time of the PulaJet nozzle can be corrected by using the offset value. The default value is 0ms. For example: If the offset value is set to -1ms, the on period will be decreased by 1ms and the off period will be increased by 1ms.

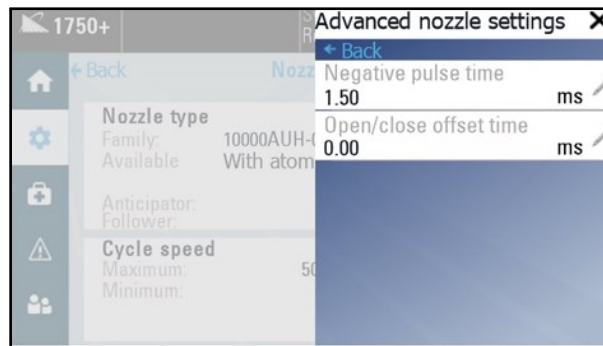

Editing Advanced Nozzle Settings

If a nozzle wear cycle count alarm has been activated, the counter must be reset in this screen after the nozzle has been replaced.



CYCLE SPEED

The maximum frequency parameter (f_{max}) determines the maximum speed of the nozzle at 50% duty cycle and is entered as a number of cycles/minute. This parameter can be found in the datasheet of the electric spray nozzle being used.

The spray control panel will calculate the cycle speed to conform to the following requirements (in this order):

- As slow as possible to prevent wear of the spray nozzle.
- Correct duty cycle this means $ON\text{-time} / (ON\text{-time} + OFF\text{-time}) = \text{duty cycle}$.
- OFF time lower or equal than the maximum on/off time parameter. This prevents striping and very low frequencies at low duty cycles.
- ON time lower or equal than the maximum on/off time parameter. This prevents striping and very low frequencies at high duty cycles.
- Frequency of the signal higher than the PWM minimum cycles/min setting. This can be used to keep the frequency constant for a large range of duty cycles.
- ON and OFF time higher than or equal to the minimum pulse width of the gun. This ensures that the nozzle is able to open and close at the same speed as the signal.

Cycle speed settings allows for the editing of the minimum and maximum cycles per minute, as well as the spray thickness. Maximum cycles speed is 7,500 cycles/min, minimum range is 0-60 cycles/min.

- **Maximum cycle speed:** Maximum speed that the nozzle should switch at for this application. This entry will be limited by the type of nozzle selected.
- **Minimum cycle speed:** Minimum cycle speed for the 1750+ is recommended for this application.

Note: If you want a constant cycle speed, enter a large spray thickness, and use the minimum cycle speed as your required cycle speed entry. The 1750+ will then cycle at this speed whenever possible.

Cycle Speed Example:

For a nozzle that can achieve 10,000 cycles/min, the minimum pulse width is 3ms. This ensures that the combination of duty cycle and cycle speed falls within the triangle curve of the PulsaJet® electric spray nozzles (See figure below). The triangle is the approximate operating range of the nozzle. As long as operating parameters (duty cycle and frequency) are inside this triangle, the nozzle will operate normally. If the operating parameters are outside the triangle, the nozzle will not operate.

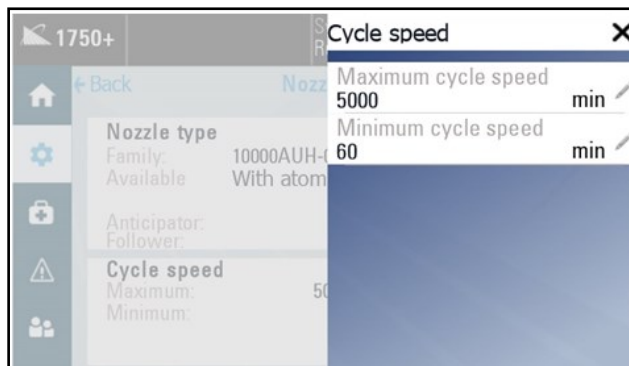

Editing Cycle Speed Settings

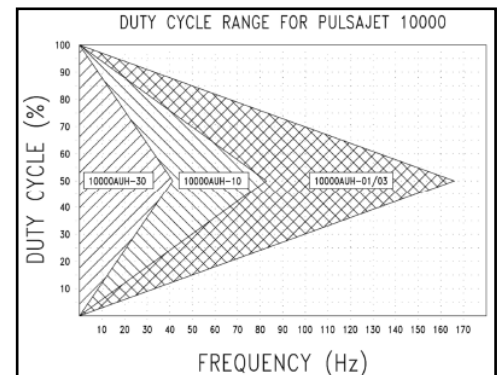

Example:

Spray Nozzle: AAB10000AUH-03

- Maximum cycle speed: 10000 cycles/min
- Minimum cycle speed: 0 cycles/min (= disabled)
- Minimum pulse width: 3ms

Objective:

- Maximum on/off time: 0.010 s or 10ms
- Duty cycle: 30%

7.2 RECIPE SETTINGS

Recipes are an optional feature that can be added with a fee to your 1750+. A recipe is a pre-configured set of parameters that allows you to change to a different production batch quickly. These parameters cover most of the timing and spray settings. Recipes can be accessed quickly from any screen by selecting the recipe section of the top bar, as shown in the image below.

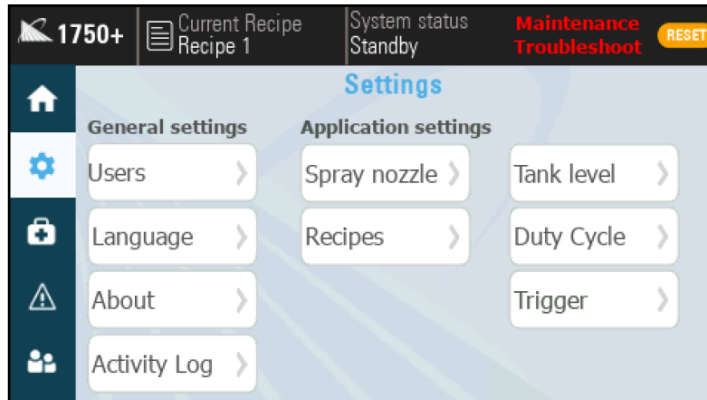

Recipe Settings screen

The recipe settings sections contains four tabs. The drop down list near the top of the page allows you to select which recipe you would like to view, edit, or apply as the current spray parameters. The 1750+ is capable of storing up to 20 user-created recipes.



Select the recipe from any screen

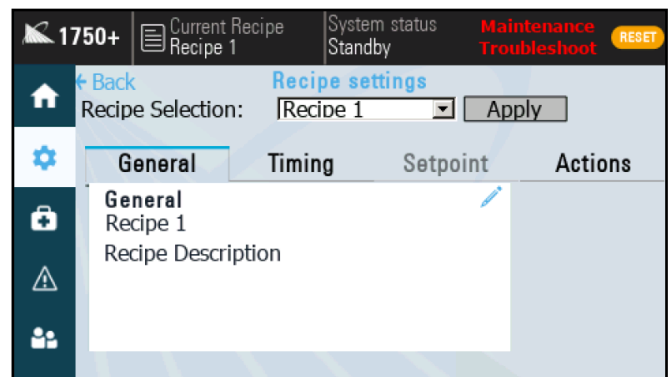

Settings screen with recipes enabled

GENERAL TAB IN RECIPES

You can change the name of the recipe and create a recipe description using the blue pencil icon. This can allow operators to easily differentiate between different recipes when changing spray parameters is required.

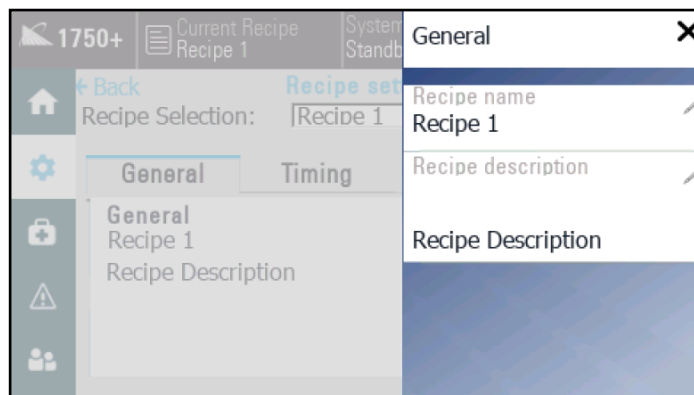

Recipe settings, General tab

7.3 SPRAY TIMING MODES

Timing modes are selected by going to the HMI settings page and selecting the “Timing” button.

The system will spray for a predetermined time depending on the timing mode selected. The spray controller allows for accurate time-based control over the spray nozzle based on an external trigger signal.

When there is a start delay value of 0 sec., the spray will start immediately after the trigger signal is sent to the 1750+, and if the stop delay is set to 0 sec. the spray will stop immediately after trigger signal goes low. All delay values can be set from 0.00 to 320.00 sec., spray times can be set to 0.01 to 320.00 sec.

SETTINGS	DETAILS
Spray Period	<ul style="list-style-type: none"> The spray period is the time the object remains under the spray nozzle or the time that it takes to dispense a dose. This will be in time units.
Start Delay	<ul style="list-style-type: none"> The time that the system should wait between a trigger event and the start of the spray. Typically, this is the distance between the sensor and the spray nozzle. The start delay must always be longer than the configured minimum signal length of the trigger.
Stop Delay	<ul style="list-style-type: none"> The time that the system should spray after a trigger event has finished. Typically this is the distance between the sensor and the spray nozzle.
Repeat Off Period	<ul style="list-style-type: none"> The Off Period is how long the system will not spray for. This must be used in conjunction with the On Period setting to have an effect.
Repeat On Period	<ul style="list-style-type: none"> The On Period is how the the system will spray for when repeat settings are used. This must be used in conjunction with the Off Period setting to have an effect.
Spray Period	<ul style="list-style-type: none"> The spray period is the duration of the spray after a trigger even is seen. <p>Note: This happens on the rising edge of the trigger event.</p>
Anticipator Time*	<ul style="list-style-type: none"> This is used to send air to the nozzles prior to the spray starting. This setting must be less than the Start delay. If this value is the same as or larger than the start delay. The air and spray will activate simultaneously.
Follower Time*	<ul style="list-style-type: none"> This is used to continue sending air to the nozzles after a spray period has finished. This setting must be longer than the stop delay to keep air flowing after a spray period has finished. <p>Note: Be careful that the Follower time does not carry over into the Anticipator time. This will result in the air staying open between spray periods.</p>

* For more information about anticipator/follower time see section 7.1 Spray Nozzle Settings.

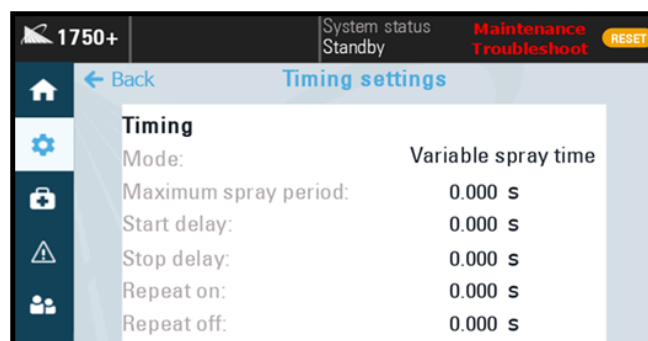

Timing settings

7.4 FIXED SPRAY TIME

This timing mode is used to create a delayed spray pulse for a fixed predetermined amount of time. The system will spray after a trigger, then stops until next trigger event occurs. For every trigger, there is a single spray event.

Set parameter value to 0.

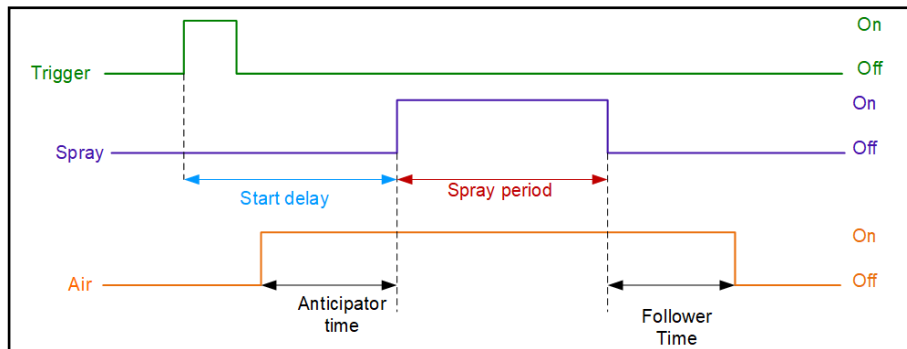

Fixed spray period

ANTICIPATOR PRIORITY

By default, the system gives priority to the start delay, potentially resulting in a too short or a zero-anticipator time, which may negatively impact the spray pattern if the start delay is too short.

In this case, the start delay will be extended as required to provide a correct anticipator time. This is particularly useful when the start delay may not be known beforehand, for example when setting the timing using analog signals.

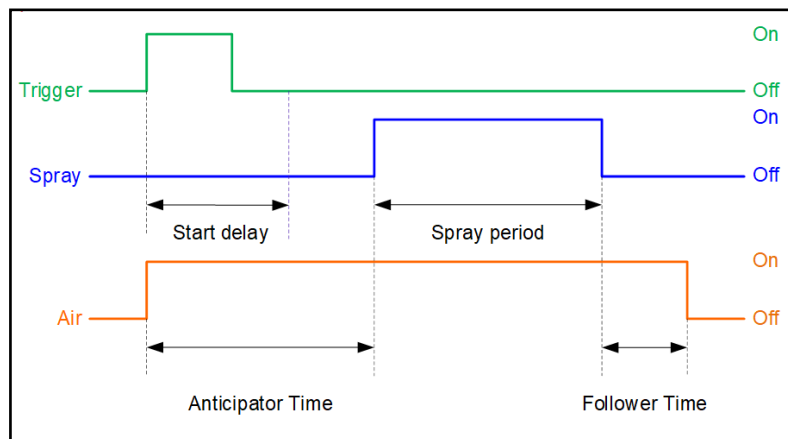

Anticipator Priority

SPECIAL CASE: MULTIPLE TRIGGERS WITHOUT SPRAY OVERLAP

Occurs if the system receives multiple start events (rising edge of trigger signal) before a spray cycle is finished. If the time delay between two successive start events (or trigger pulses) is higher than the spray time, then there is no overlap.

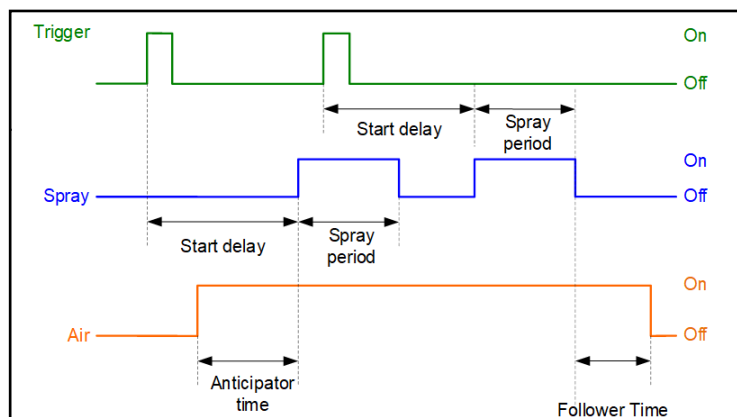

Multiple Triggers without Spray Overlap

SPECIAL CASE: MULTIPLE TRIGGERS WITH SPRAY OVERLAP

Occurs if the system receives multiple start events (rising edge of trigger signal) before a spray cycle is finished. If the time delay between two successive start events (or trigger pulses) is lower than the spray time, then there is an overlap of two successive spray pulses.

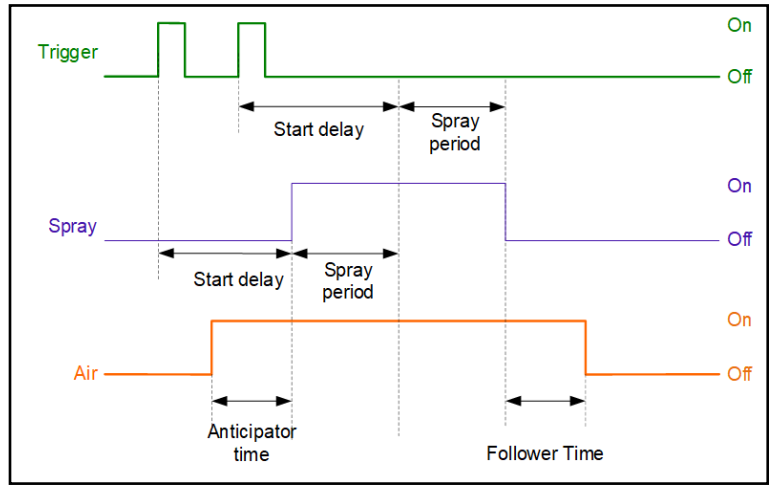

Multiple Triggers with Spray Overlap

FIXED SPRAY TIME– WITH REPEAT SPRAY

This timing mode is used to create a continuous repetition of spray period for a fixed time.

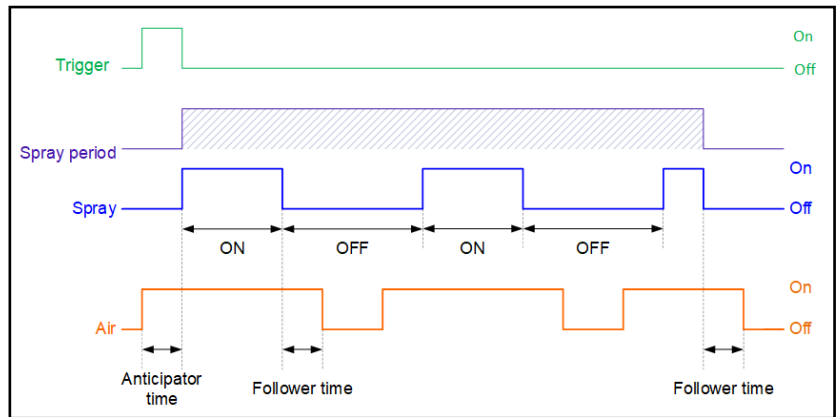

Repeat Spray

Special Case: Repeat Spray, Air Overlap: If repeat off-time \leq (anticipator + follower time), the air will remain on.

Note: This can happen in both fixed and Variable spray times.

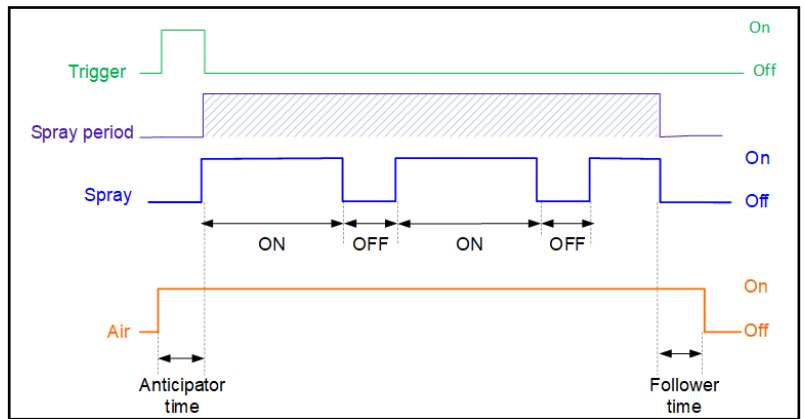

Repeat spray, air overlap

7.5 VARIABLE SPRAY TIME

The system will spray for a period based on the detected length of a product. Instead of entering a fixed spray period, an upper limit can be configured. The resulting spray period will be determined by the detection of the start and end of a trigger signal, with a fixed start and end delay.

This timing mode is used to create a delayed spray pulse that is referenced from the trigger start and stop events. The start and stop delay are typically the same as the time between the object sensor and the spray nozzle.

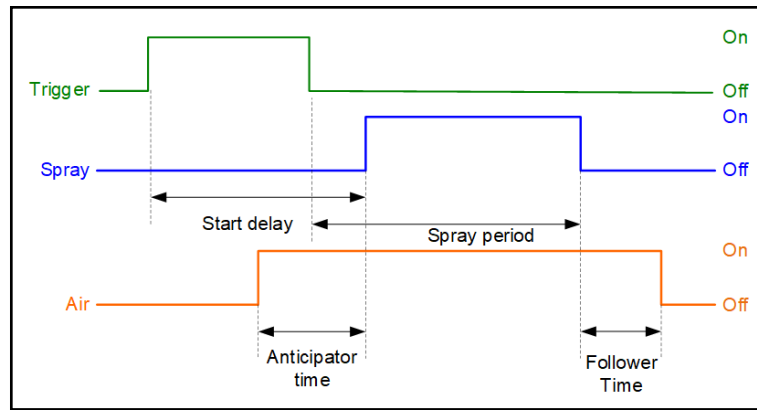

Variable spray period

INCREASE SPRAY PERIOD

- Decrease Start-delay: The spray is started before the object has reached the spray nozzle.
- Increase Stop-delay: The spray continues after the object has passed the spray nozzle.

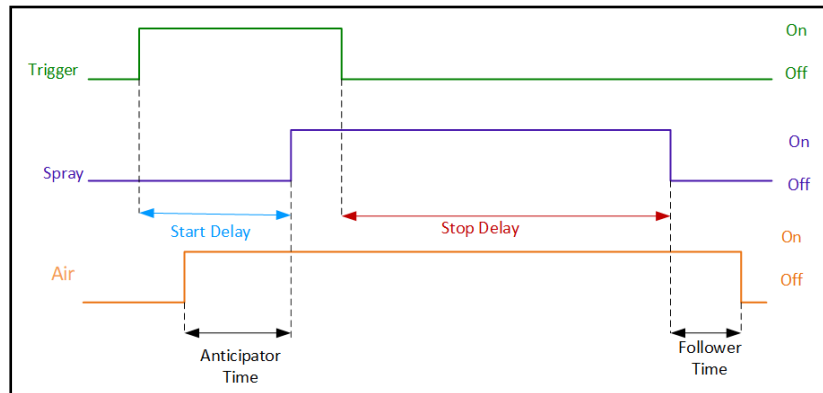

Increased spray period

DECREASING SPRAY PERIOD

The spray length can be decreased by:

- Increasing the Start Spray Delay: the spray is started after the object is already under the spray nozzle. In this case the beginning of the object is not sprayed.
- Decreasing the Stop Spray Delay: the spray stops before the object has completely past the spray nozzle. In this case the end of the object is not sprayed.

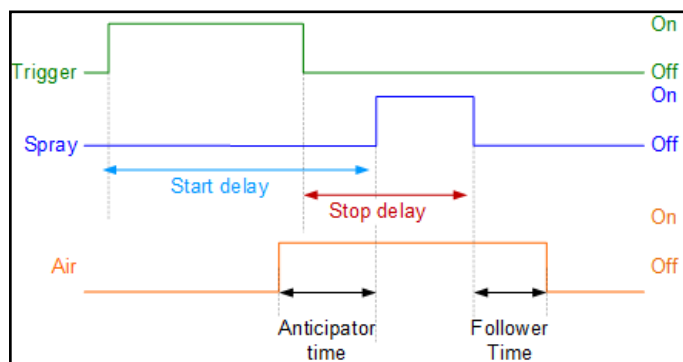

Variable spray length—decreasing spray length

MULTIPLE TRIGGER EVENTS DURING SPRAY

If the system receives multiple start events before the spray cycle is finished, they will be added to a queue and executed according to the given delay times.

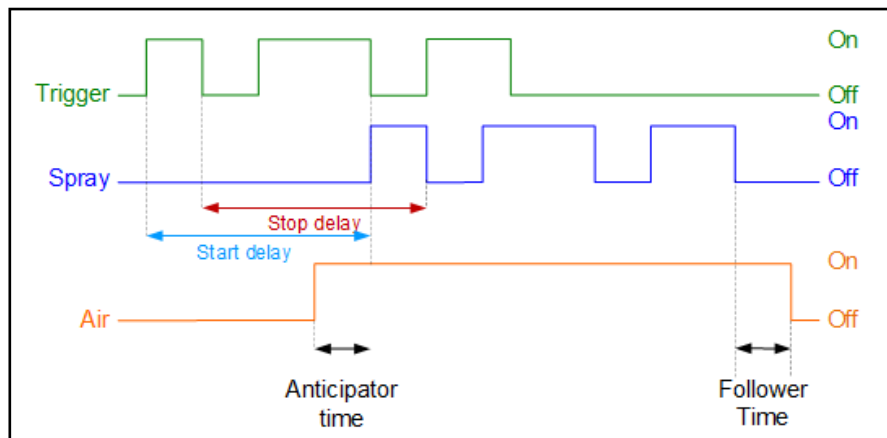

Variable spray period—multiple triggers

OVERLAPPING SPRAY EVENTS

If spray events overlap, the overlapping event will be ignored, and the system will continue to spray to ensure the objects are sprayed correctly. This situation may occur when the following is true:

- Stop delay > Start delay
- Delay between two objects < (stop delay - start delay)

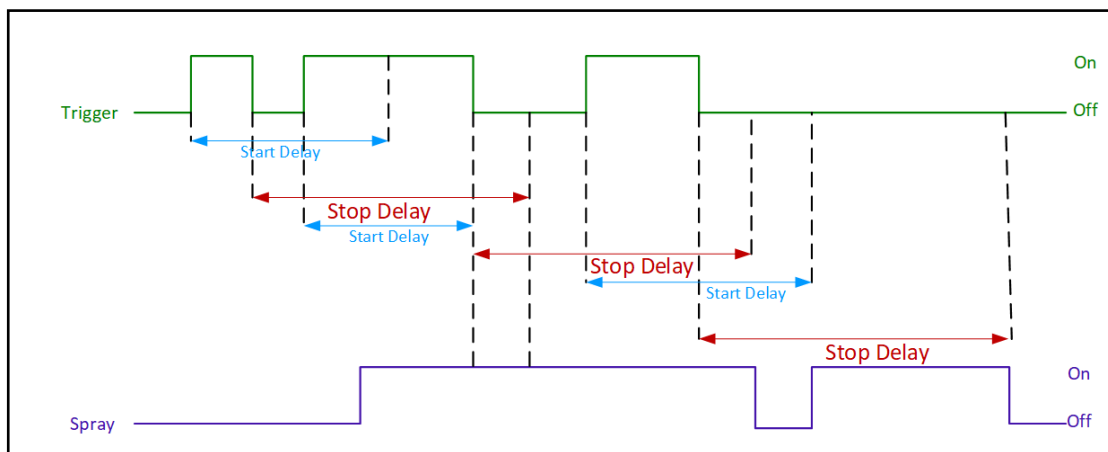

Variable Spray Period – Overlapping Triggers

OBJECTS TOO SMALL

If spray events overlap, the overlapping event will be ignored, and the system will skip the small object.

This situation may occur when the following is true:

- Stop delay < Start delay
- Object size < (start delay - stop delay)

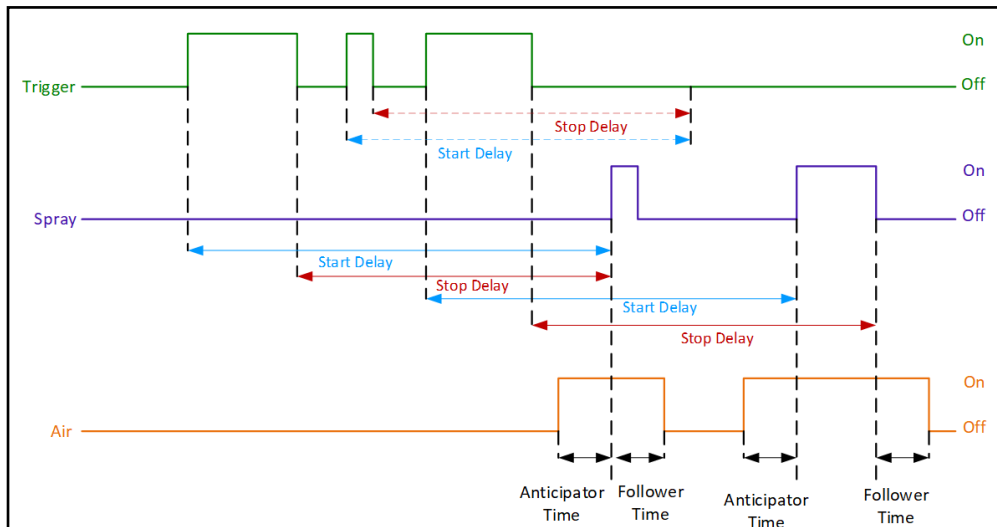

Variable Spray Period—Objects too small

DISTANCE DELAY, MAXIMUM SPRAY PERIOD

This timing mode is used to create a delayed spray pulse of an unknown period when receiving a trigger signal.

- The start and stop delays are typically the distance between the object sensor and the spray nozzle.
- The spray period is limited in time to the configured spray period.

In this timing mode, the repeat functionality works in time units.

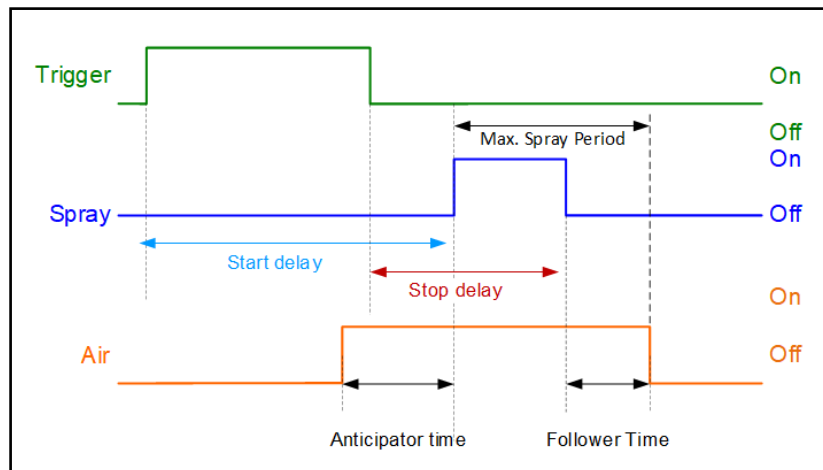

Distance delay, max. spray period

7.6 DUTY CYCLE

Duty cycle represents the ratio of the spraying "on" time to the "off" time, which results in some percentage of the maximum possible (continuous) flow through the nozzle. The duty cycle settings allow you to select the source and enter sensor default values. Selecting 4-20mA signal will allow you to configure your sensor. The other option is remote setpoint, which requires a cable to connect to an external PLC. When connected correctly, the Duty Cycle on the controller display adjusts according to the input signal, 4mA corresponds to 0% duty cycle and 20 mA corresponds to 100% on.

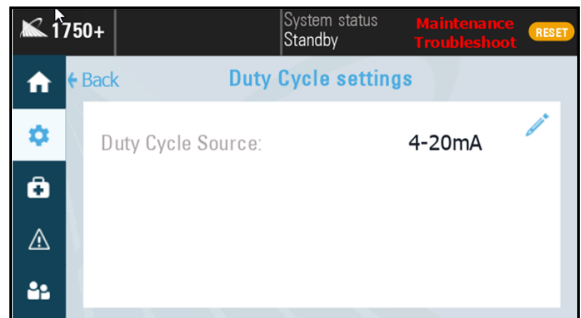
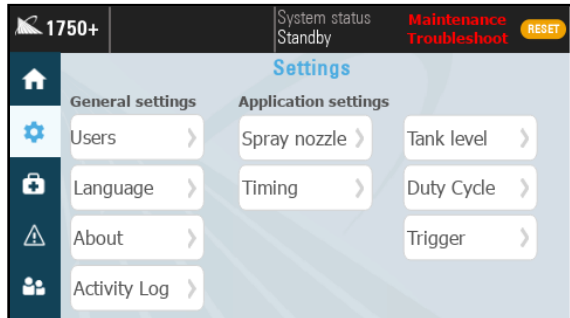

Duty Cycle Settings

DUTY CYCLE SETTINGS

Select whether the duty cycle source will be local or 4-20mA signal.

- **Sensor Value at offset:** The minimum value of percent that offset the starting point to control Duty Cycle.
- **Sensor Value at 20mA:** The maximum value of setpoint for the remote duty cycle to control. Set the value at 20mA to be 100% or another value depending on your trigger source.
- **Sensor Offset:** The minimum level of the sensor offset can control usually starting from 0mA or 4mA. Set the sensor Offset to match the baseline mA value of your sensor (lowest value).
- **Filter Time:** Used to control interference/noisy signals from sensor.

Assembly Specifications:

- Panel connection: 4-20mA
- Part number: LE00M8M5M
- Cable: 16.4 ft. [5 m] cord
- Flying Leads
- Connector – M8 4 pin male

—DO2 represents your spray status in the form of an On/Off signal depending on whether the 1750+ is actively spraying. This can be used to monitor the active status externally.

Color Code: Duty Cycle			
Pin#	Color	Description	
1	Brown	+24 VDC	
2	White	DO2	
3	Blue	0 VDC	←
4	Black	4-20mA	

If your 0 VDC is coming from a power supply outside of our panel (PLC), connect it to this wire—#3

REMOTE

SETPOINT (AI2) [0-20MA] DUTY CYCLE

The duty cycle setpoint is multiplied by the value of the input to calculate the actual duty cycle. The following equation represents the calculation made by the 1750+.

$$\text{Duty cycle of the spray gun} = (\text{Duty cycle setpoint}(\%) \times \text{measured value}(\%)) + \text{Duty cycle offset}(\%)$$

7.7 TRIGGER

If you have an external trigger source, select the correct and corresponding option for your external trigger from the drop down list. Toggling the “Inverted” option to the On position will allow the use of a trigger that sends a signal when off rather than when on. Tracks up to 50 objects.

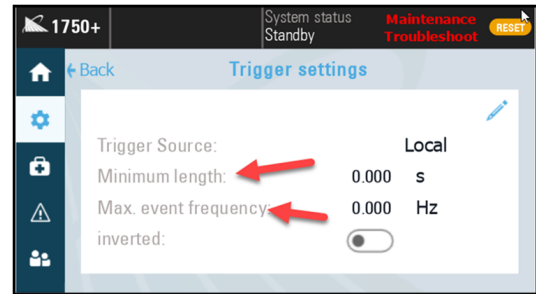
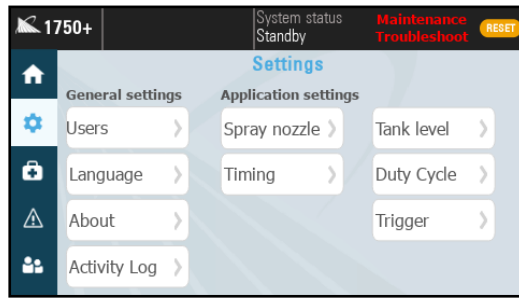

TRIGGER SETTINGS

Trigger Settings

- **Minimum length:** Filters out a trigger signal that is less than the specified time. This setting can only be used while there is a start delay.
- **Max. event frequency:** When the max trigger frequency is exceeded, the signal is treated as noise and will not give the controller a trigger signal. A higher max frequency allows for more noise and could cause unnecessary triggers from a bad signal. Signals that have some noise, but should still be considered triggers should be accounted for with this setting.
- **Trigger Source:**
 - Local- Selecting “Local” as a trigger source will place a trigger button on the home screen that must be pressed every time the system needs to be triggered.
 - DI2- Trigger is activated via the "Trigger Connection"
 - DI2+DI4 - DI4 is the trigger interlock connection. This will place the system into standby mode when DI4 is low. DI2 operates as normal when in run mode.

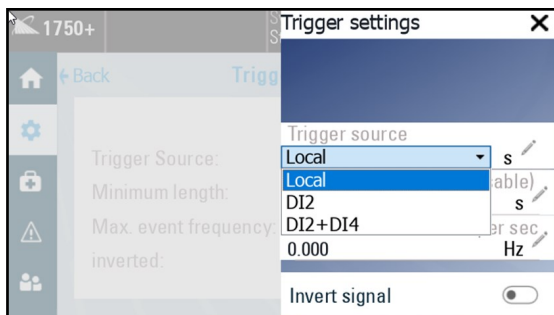

Trigger settings

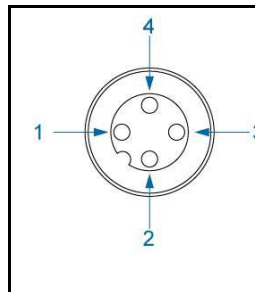

Color Code: Trigger		
Pin #	Color	Description
1	Brown	+24 VDC(only used for sensors)
2	white	Not Conncted
3	Blue	0VDC
4	Black	DI2

Note: Do not supply pins 2 or 5 with the 24V model.

- **Trigger Interlock:** Controls the state of run/standby. When the signal is low it will put the system in standby mode and spraying will stop. When the signal is high again it will be put back into run mode.

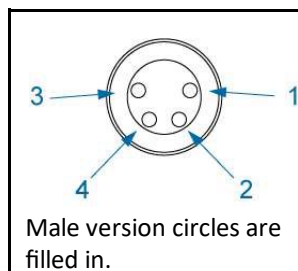

Color Code: Trigger Interlock		
Pin #	Color	Description
1	Brown	+24 VDC
2	white	DI4
3	Blue	0VDC
4	Black	Level Sensor

7.8 TANK LEVEL (LEVEL SENSOR)

If your configuration includes a pressure pot with a level switch, select the edit button and use the drop down menu to activate the level sensor signal. Once turned on the 1750+ can now see the low level condition.

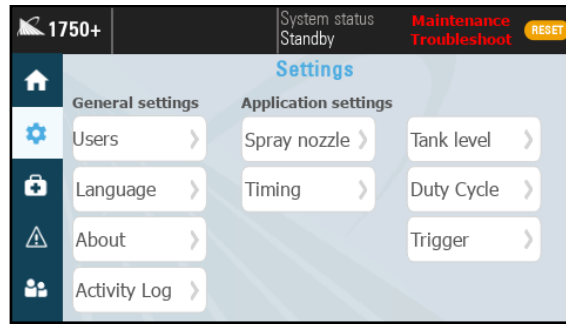

Tank level sensor settings

TANK LEVEL SENSOR SETTINGS

- **Input status**—Shows low level regardless if input is turned on.
- **Status**—If input is turned on and level is low this will toggle on.
- **Invert signal**—If you have a normally open level switch (open until liquid level goes low) do not turn this on, if you are using a normally closed float, toggle this on.
- **Standby on fault** —If you want the spray to stop when level goes low toggle this on.



ATTENTION: When the tank level is low, the 1750+ will show a fault on the screen (tank low), but it will not stop the nozzle from spraying. Toggle on “Go to standby on fault” if you want the 1750+ to stop spraying when the tank level gets low. The level sensor will send the alarm signal based on its current configuration values.

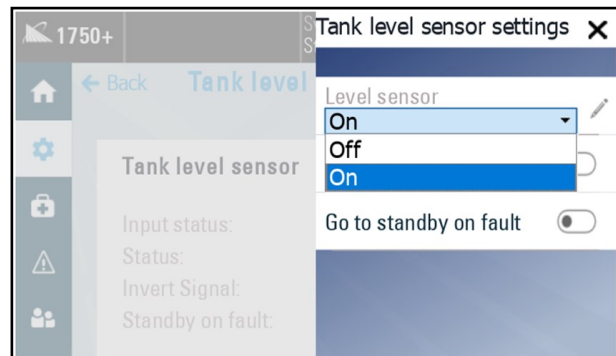
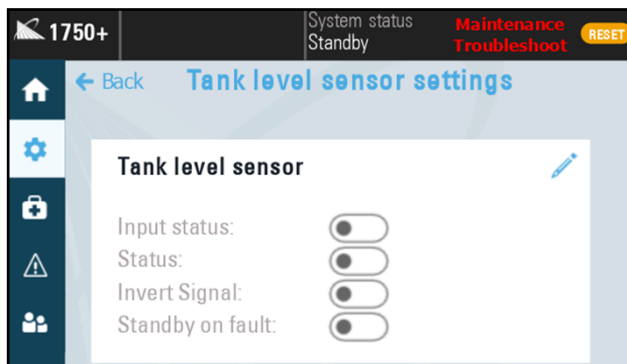

Editing tank level sensor settings

SECTION 8 ALARMS

8.1 ALARM SETTINGS



When the alarm indicator in the left-hand icon menu is illuminated yellow/orange, the 1750+ has detected that there is an alarm present.

Some alarms are recoverable, but certain alarms can result in the 1750+ entering standby mode. When this happens, triggering signals or events will no longer be accepted until the reason for the alarm has been corrected. However, the spray control panel will still display the alarm condition on the alarm history screen. Once the alarm has been corrected, complete a power cycle of the 1750+ to reset and clear the alarm.



Pressing the orange reset button in the top right-hand corner of the screen will also reset any active alarm that occurs due to a recoverable alarm.

The alarm history screen will show a record of all past alarms. It will list the time that each alarm occurred, and will also show the alarm description. You can select the time period that you would like to view using the “Duration” drop down menu and pressing “Refresh” to see the updated results.

See the *Alarms and Troubleshooting* section to correct the displayed alarm.

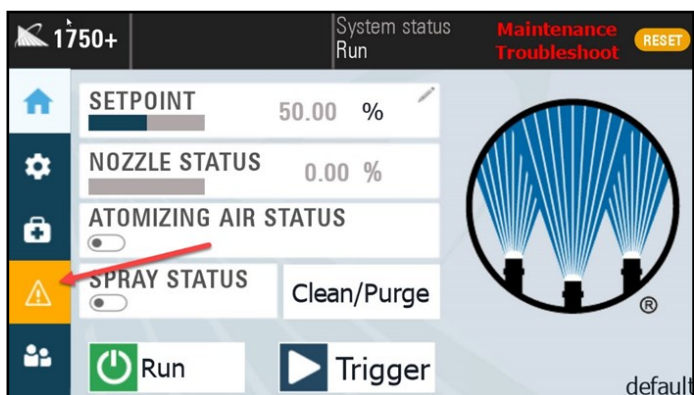

Active alarm trigger warning icon

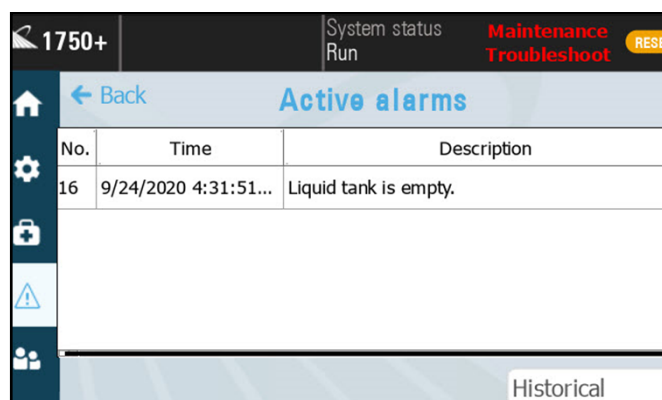

Active alarms screen

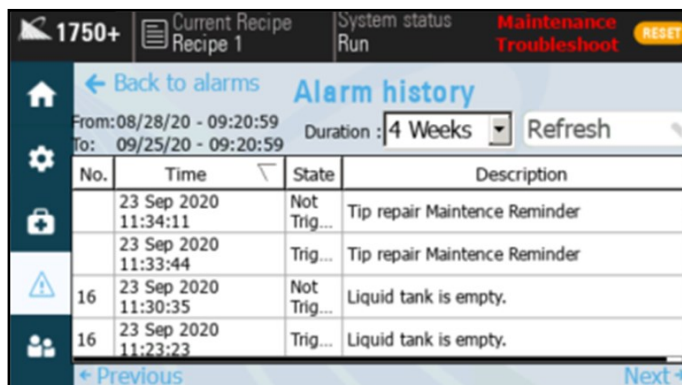

Alarm history screen

MAINTENANCE AND TROUBLESHOOTING

9.1 MAINTENANCE AND TROUBLESHOOTING TAB

The 1750+ is equipped with an internal maintenance scheduler. This allows you to create and set Preventative Maintenance (PMs) events. These events can include anything from routine cleanings to specific events like component repair or replacement. Select Maintenance and Troubleshooting tab to access PMs, a spare parts list, and your Spray Specialist's Tech contact information.

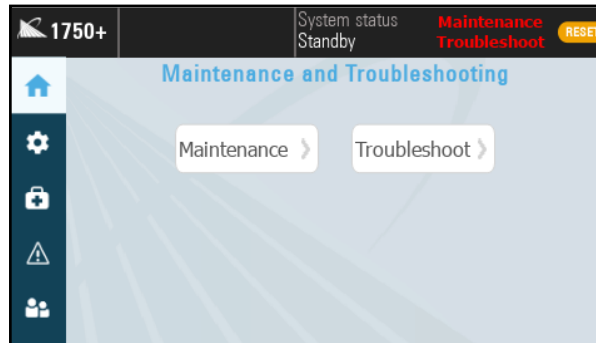

Maintenance and Troubleshooting tab

SCHEDULER TAB

The Scheduler tab will show all upcoming PMs (Preventative Maintenance). PMs will show the date of next occurrence, and are able to be toggled on and off. When the PM is due, a notice will show up on the alarm screen and the name box will change from green to red. The scheduler screen can enable or disable PMs by using the button in the "Enable" column. The button will be blue when enabled.

Name	Next PM	Enable	Name	Next PM	Enable
Pump Repair Std		<input type="checkbox"/>	Coil Repair		<input type="checkbox"/>
Pump Repair FC		<input type="checkbox"/>	Plunger Repair		<input type="checkbox"/>
Reg Repair Std		<input type="checkbox"/>	Schedule 7		<input type="checkbox"/>
Reg Repair FC		<input type="checkbox"/>	Schedule 8		<input type="checkbox"/>

Maintenance Scheduler

CREATE PMS (PREVENTATIVE MAINTENANCE) TAB

This allows for the creation of PMs that will appear on the “Scheduler” tab after the parameters have been created and the “Update PM” button has been pressed. Time frequency of the PM can be set to months or nozzle cycles.

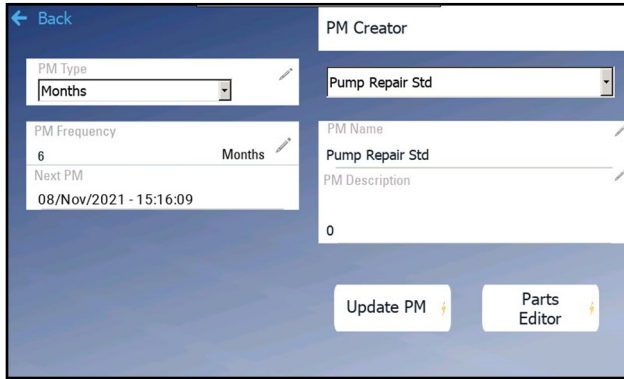

PM creator screen, editing the PM

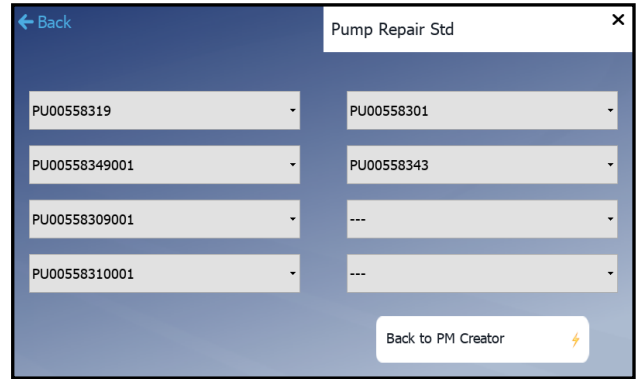

PM Parts List for a Pump Repair Std

SPARE PARTS AND SPRAY SPECIALIST TABS

A complete list of spare parts for your specific system configuration can be found by selecting the Spare Parts tab. Parts can be selected from the drop down list and the part description can be viewed or edited.

The contact information for your local Spraying Systems Co.® Spray Specialist can be found by selecting the *Spray Specialist* tab. These editable boxes contain the name, phone number, and email address of your Spray Specialist.

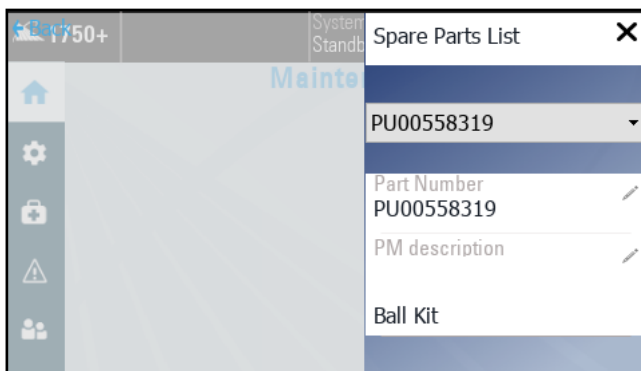

Spare Parts List



Spray Specialist Info

TROUBLESHOOTING

The 1750+ provides troubleshooting tips for some of the most common issues that may occur and steps to resolve any problems. This feature provides some troubleshooting measures you can take to try and resolve your issue before contacting your local Spray Specialist for support.

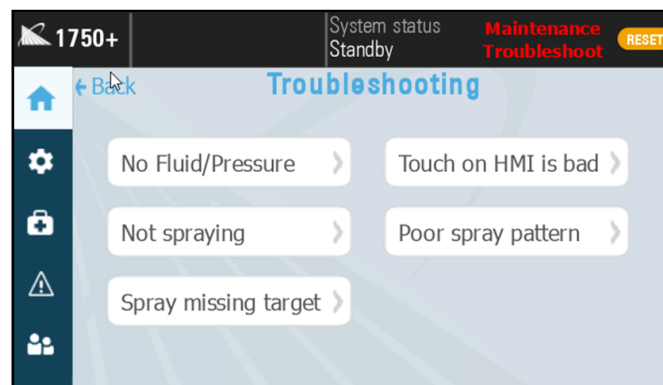

Once the issue is selected, you will see several prompts for each issue. These prompts could suggest an action to preform to try and resolve the issue, a system component to check, or direct you to the system manual.

SECTION 10

DIAGNOSTICS

The diagnostics screen is a tool to help with system troubleshooting. This screen groups together real-time readings from connected digital and analog inputs and accessories and displays all of the read-only values in one location. These values can help to diagnose the cause of any alarms.

See *Alarms and Troubleshooting* section for more information.

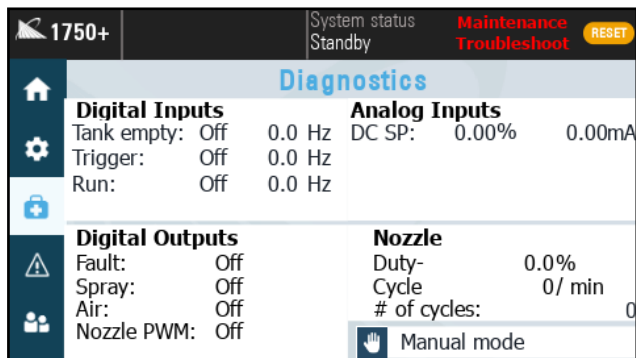

Diagnostics screen

SECTION 11

ALARMS AND TROUBLESHOOTING

ALARMS	TOL. TIME	CAUSE	SOLUTION
General/Gun output error	0s	This is normally caused by a short in a nozzle cable or coil. This is the most common alarm.	Check all connections and coils for electric nozzles, or attached devices on the nozzle output cables.
Source current too high	1s	The source current on PWM+ is higher than 6A.	Check all connections; look for shorts. Use ammeter if required.
Remote 4-20mA alarm	1s	The current on AI1 is lower than AI1 offset (4mA). There is a problem with the sensor, or the wire is broken.	Check the connections and wiring on AI1. If not being used, set duty cycle option to "local".
Sink current too high	1s	The sink current on PWM- is higher than 6A.	Check all connections; distribute guns over multiple 2008 modules.
Internal temperature too high	1s	The temperature in the module is too high.	Provide sufficient cooling in the cabinet where the module is located.
High Voltage	1s	The voltage on the +Vin input is higher than 57V.	Use a suitable power supply, check power supply (20 – 57 V)
Low voltage	3s	The voltage on the +Vin input is lower than 20V.	Use a suitable power supply, check power supply (20 – 57 V)
Tank empty	1s	Tank level signals the tank is empty	Fill the tank, verify the level switch is functioning, invert the switch.

HMI COMMUNICATION ALARM

You will see small yellow triangles on the screen. Note this error occurs if the HMI is not communicating with the gun driver control board. Reboot the controller and if this does not fix the issue then consult with the factory.

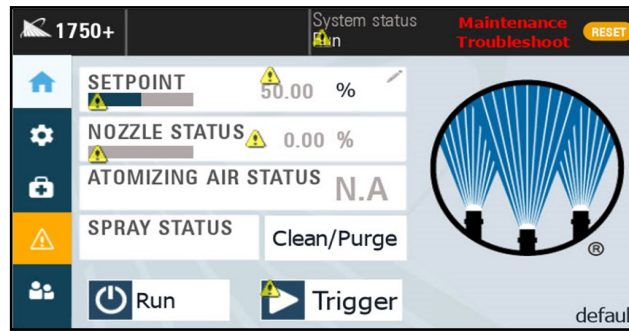

HMI communication alarms

ALARMS AND SOLUTIONS:

⇒ **Controller will not power up:** The main power indicator (RED LED) does NOT illuminate.

Check to ensure power cord is plugged into controller and power outlet and power switch is in the “on” position.

Follow these steps to check fuse on internal power rail:

- 1) Unplug the system.
- 2) Remove four (4) screws in the corners of the Pane Cover plate (using #2 Philips screwdriver).
- 3) Carefully remove plate. Take care to not put stress on the wires.
- 4) Check the panel for any loose wires.
- 5) Locate the fuse holder to the right of the power supply and lift the tab on the top of the fuse holder exposing the fuse.
- 6) Due to the type of fuse used, a qualified electrical technician should test the fuse and replace if necessary. (5-amp slow blow)
- 7) Replace plate to its original location and attach using the four (4) screws.

-If the controller still will not power up, contact your local Spray Specialist by calling 1-800-95-SPRAY

(1-800-957-7729) or call 1-866-321-2250 to order a replacement control panel.



⇒ **Controller will not power up:** The main power indicator light (red LED near power switch), DOES illuminate.

Follow these steps to check power connection on the HMI;

- 1) Unplug the system.
- 2) Carefully open the panel. Take care to not put stress on the wires or scratch the HMI screen.
- 3) Ensure that there are no loose wires in the system.
- 4) Close the panel



⇒ **Controller will not operate spray nozzle.**

- Ensure that there is proper fluid pressure supplied to the nozzle.
- Ensure that system is recognizing your trigger input. This is a common problem. If remote trigger/sensor is being used and button on the setup screen is set to “local”, the system cannot be recognized, the system trigger needs to be set to something other than “local”. The inverse is also true, if the system is being triggered off the HMI screen, the trigger option must be set to “local”. Make sure your sensor is NPN design if you are using your own sensor.

- 1) Ensure that the trigger mode is set to Local, DI2 or DI1+ DI2.
- 2) Navigate to the diagnostic screen.
- 3) Activate the main trigger source (object sensor or equivalent): DI2 on diagnostic screen should go from a value of 0 to a value of 1 when the trigger device is activated.
 - If this does not occur, then ensure that the trigger device is properly wired.
 - If problem still occurs, then consult the manufacturer’s manual for the trigger device.
- 4) If trigger mode is DI1+ DI2, activate the auxiliary trigger: DI1 on diagnostic screen should go from a value of 0 to a value of 1 when the trigger device is activated.
 - If this does not occur, then ensure that the trigger device is properly wired.
 - If problem still occurs, then consult the manufacturer’s manual for the trigger device.

⇒ **For electrically actuated spray nozzles:**

- 1) Check that the nozzle cable is properly installed on both ends with no damage to the cable.
- 2) Set duty cycle to 100% from main screen and attempt to trigger again.
 - If the nozzle activates you may have selected a duty cycle too low or, max frequency too high for the nozzle you are using.
 - If the problem persists have a qualified electrical technician, ensure that there is 24 VDC on the nozzle cable when the system is triggered.

⇒ **For pneumatically actuated spray nozzles:**

- Ensure that there is a minimum of 45 psi (3.1 bar) of air pressure on the main air input to the system and that the main air valve is in the “on” position.
 - Check air supply.
- 1) Ensure that the valve cable is connected to the main output on the controller.
 - 2) Remove Cylinder air tube from the outside port of the system.
 - 3) Trigger the system to see if air comes out of the port.
 - 4) If air comes out there is an issue with the cylinder on your nozzle. Contact your local Spray Specialist for information on repairing or replacing your nozzle.
 - If no air comes out, contact your local Spray Specialist by calling 1-800-95-SPRAY (1-800-957-7729) or call 1-866-321-2250 to order a replacement air valve.

TRIGGER DEVICES AND ACCESSORIES

12.1 ELECTRIC NOZZLE CORD SET

If the system is designed to operate Spraying Systems Co.® PulaJet or AA250 electric actuated spray nozzles, the system is supplied with a cord to connect the spray nozzle to the Control Panels. All the electric actuated nozzle cord sets are wired as shown in the diagram.

AA10000 SERIES PULSAJET NOZZLE CABLE

- Panel connection: Main
- Part number: LEXXSD3M83F030P
- Cable: 9.8 ft. [3 m] cord length
- Connector – M8 3 pin female
- Connector – M12 3 pin male

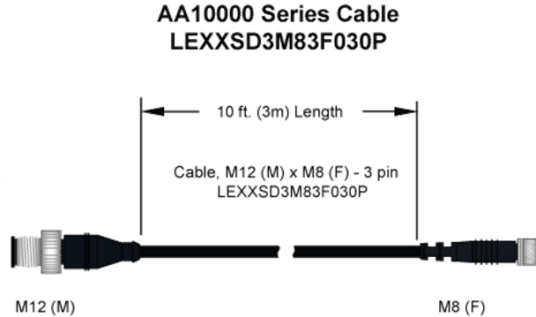

AA250AUH ELECTRIC NOZZLE CABLE

- Panel connection: Main
- Part number: LE00M12MMDIN3MU
- Cable: 9.8 ft. [3 m] cord length
- Connector – Mini DIN
- Connector – M12 3 pin male

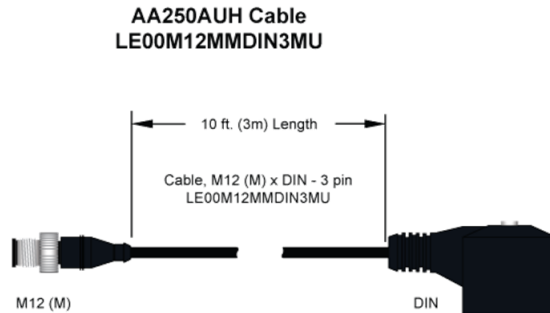

ELECTRICAL JUNCTION BLOCK

If multiple PulaJet or AA250 electric spray nozzles are used the system comes complete with a junction block to connect the spray nozzles to the unit. The junction block is available in two versions: four (4) and eight (8) nozzle connections.



12.2 TRIGGER CABLE

Optional trigger cable offering: Un-terminated flying lead cable and connector.

REQUIRED INPUT

- Part number - LE00M12F5M – M12(f) x bare lead trigger cable
- NPN – Switch to 0 VDC to turn on spray trigger.
 - Requires NPN Sensor or dry contact switch.
- Connects to the connector labeled “Trig.” On the bottom of the panel.

ASSEMBLY SPECIFICATIONS:

- Panel connection: Trig (Software trigger choice - DI2)
- Cable: 16.4 ft. [5 m] cord length
- Flying Leads
- Connector end—M12 4 pin female



Note: Connect pins 3 & 4 with a switch or dry contact relay to initiate trigger.



WARNING: Never connect pin 1 (24vdc) to any other pin unless you are wiring in your own 24VDC sensor. Doing so could cause equipment damage. (Cut the brown and white wire if you're not using them)

Color Code: Trigger		
Pin #	Color	Description
1	Brown	+24 VDC(only used for sensors)
2	white	Not Conncted
3	Blue	0VDC
4	Black	DI2

Note: Do not supply pins 2 or 5 with the 24V model.

12.3 PHOTOELECTRIC OBJECT SENSOR

Infrared – direct reflection sensor with cable and connector, this is our standard sensor offering, it should work in most cases.

SPECIFICATIONS:

- Kit number: 040TS04000014W0
- Photoelectric sensor – Infrared – direct reflection sensor with cable, connector, and bracket.
- NPN – NO + NC
- 35 inch [900 mm] sensing range
- Setting distance adjustable between 6 and 36 inches [150 and 900 mm]
- Working temperature range = -4°F to 158°F [-20°C to 70°C]
- IP67; CE rated

ASSEMBLY SPECIFICATIONS:

- Panel connection: Trig
- Cable: 16.4 ft. [5 m] cord length
- Connector – M12 4 pin female

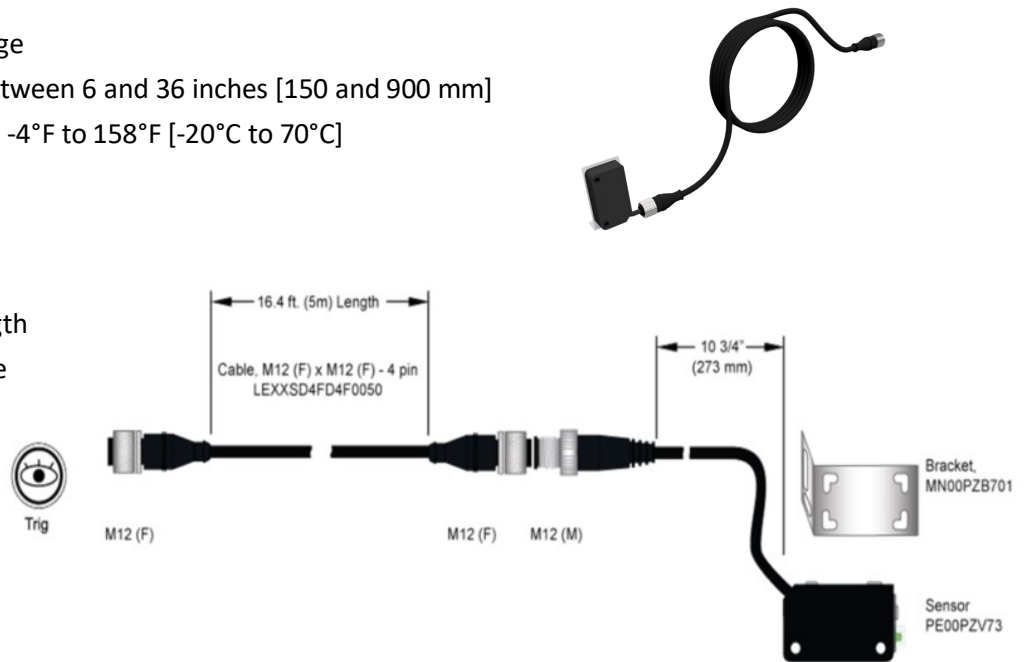

12.4 COLOR SENSOR

Full-Spectrum color, detects color/brightness/surface finish/intensity, NPN/PNP, IP65/ IP67 rating, 1.18 to 19.69 in. detectable distance.



12.5 PROXIMITY SENSOR

For sensing metallic objects. Kit includes sensor, with mounting nuts and locking washer, and cable.

SPECIFICATIONS:

Proximity sensor – Detects all metals 10mm max. sense dist., 24vdc, NPN outputs N.O./N.C., shielded, IP67, 5m cable wired

- Kit number: 040TS04000118W0
- NPN – NO + NC
- Working temperature range = -13°F to 176°F [-25°C to 80°C]
- IP67, NEMA type 6 (waterproof); CE rated



12.6 TRIGGER INTERLOCK

SCS Series spray control panels feature an optional secondary run enabled trigger (Trigger Interlock feature) or a digital input for a level switch.

For the secondary run trigger (DI4), this feature provides a way for you to provide a run signal to the spray control panel. If this signal is not present, then the system will ignore the trigger signal. An example of this would be if you do not want the nozzle to spray unless the conveyor is running and there is a part present to spray. This input always goes to 0V, pin 3. To activate this feature on the HMI, go to settings/trigger and pick trigger source DI2+DI4.

For the level switch option (DI1), this feature allows you to wire in a normally open or normally closed level switch from a liquid tote or tank. When the tank runs low and the level switch contact closes or opens, the spray control panel will display an alarm. To use these features, you need our cable part number LE00M8F5M. This input always goes to 0V, pin 3. To activate this feature on the HMI, go to settings/tank level and turn on under level sensor.

SPECIFICATIONS:

- Kit number: LE00M8F5M
- Panel connection: T. int.
- Cable: 16.4 ft. [5 m] cord length
- Flying Leads
- Connector end – M8 4 pin female

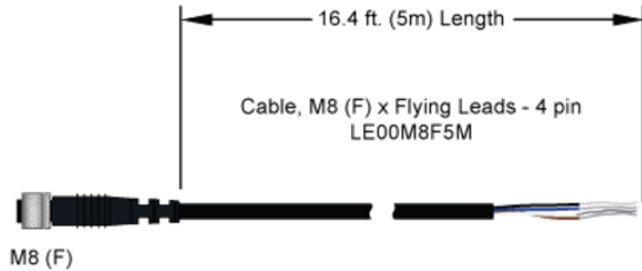

		Color Code	
Pin #	Color	Description	
1	Brown	+ 24VDC (not used)	
2	White	DI4	
3	Blue	0 VDC	
4	Black	DI1	

12.7 FOOT SWITCH

For manual triggering of the system. Heavy duty foot switch provides for hands free triggering in a manual triggering application.

SPECIFICATIONS:

- Kit number: 040TS04000130W0
- Momentary on switch
 - Wired normally open (can be wired normally closed)
- M12 (F) connector – connects to “Main” on control panel - 4 pin
- 16.4 ft (5m) cable length

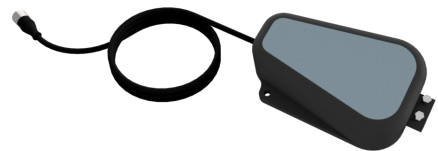

12.8 HAND TRIGGER PENDANT

For manual triggering of the system. The unit offers two switches to independently trigger the system. Cable length offers flexibility in location of operation.

SPECIFICATIONS:

- Part number: SW001550M12HT
- 2 Switches
 - 1 - On/Off selector switch
 - 1 – Pushbutton – momentary on button
- 1550, hand trigger pendant, selector switch and button, M12 female 4 pole, 5 meter cable.

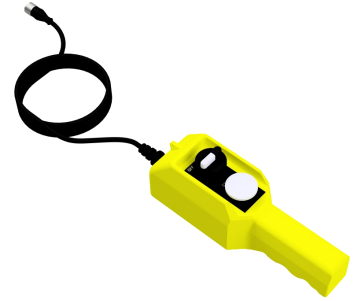

12.9 Thru-Beam Sensor

Infrared - thru beam sensor with cables, wye connector and brackets. To set this up you need to use all three cables and the splitter. The thru beam has a sensor and a receiver. Each gets a cable connecting it to the splitter. Then the splitter has a cable to connect it to the system.

The receiver goes to port 1 on the wye splitter, and sensor cable goes to port 2. Refer to the manufacturers' data sheet for more information on setting up the sensor for use.

SPECIFICATIONS:

Photoelectric sensor – Infrared – direct reflection sensor with cable, connector, and bracket.

- Kit number: 040TS04000028W0
- NPN – NO + NC
- 65.6 feet [20 m] sensing range
- Working temperature range = -4°F to 130°F [-20°C to 55°C]
- IP67; CE rated
- IP67/IP69K rating, NPN output

ASSEMBLY SPECIFICATIONS:

- Panel connection: Trig
- Cable: 16.4 ft. [5 m] cord length, Connector – M12 4 pin female

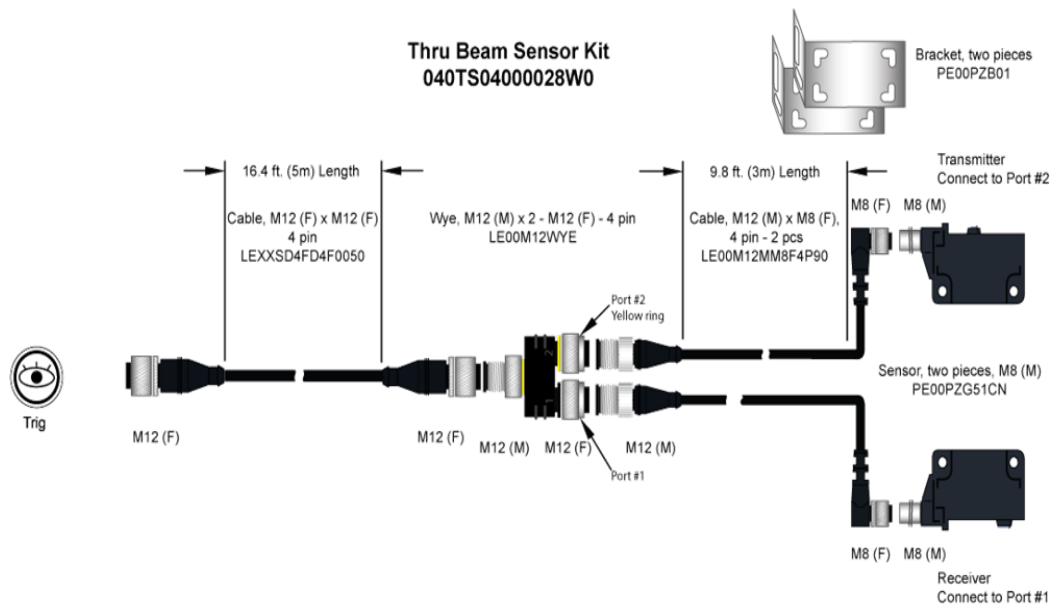

12.10 LASER SENSOR (SHORT)

For accurate short distance sensing of objects (thin, shiny, dark, clear, multi-faceted)

SPECIFICATIONS:

Laser sensor – with cable, connector, and bracket.

- Kit number: 040TS04000135W0
- NPN – NO + NC
- 1.0" – 3.5" [25mm – 90mm] sensing range (1.5mm – 3mm deviation range).
- Working temperature range = 10°F to 122°F [-10°C to 50°C]
- IP69K, NEMA 4X; CE rated
- Mounting bracket, accurate short sensing distances of 25 to 90 mm, std. detectable deviation 1.5-3.0mm, NPN/PNP open collector, 24Vdc, M12 4 pin male connection, 5m cable.



12.11 LASER SENSOR (LONG)

For accurate long-distance sensing of objects (shiny, dark, clear, multi-faceted)

SPECIFICATIONS:

Laser sensor – with cable, connector, and bracket.

- Kit number: 040TS04000087W0
- NPN – NO + NC
- 1.38" – 19.69" [35mm – 500mm] sensing range (9mm – 50mm deviation range).
- Working temperature range = 10°F to 122°F [-10°C to 50°C]
- IP69K, NEMA 4X; CE rated
- 5m cable, and mounting bracket, 24Vdc, NPN. IP68/ IP69K.

12.12 ALARM OUTPUT SIGNAL

The SCS Series spray control panels offer a feature to signal your system when an error has occurred in the operation of the spray control panel (for example a level sensor going low or a short in one of the nozzle cables). To use this feature, you need to have our optional splitter cable kit.

Wire the alarm output to any 24VDC buzzer, light, or PLC. You will need the splitter and the extra cable shown below.

- Kit 040TS04000054W0 includes both parts.

This end goes in the Main connector on the 1750+ panel. The black and the white wires from the flying leads cable get wired to your PLC or light or buzzer, snip the blue and brown wires, they are not used. Alarm cable pinout below:

If any electric nozzles are used, they get hooked up to the open M12 connector on the wye connector.

- Panel connection: Main
- Cable: M12 4 pin (M) x Flying Leads - 16.4 ft. [5 m] (Connects to one connector on splitter), flying leads (Part number: LE00M12M5M)
 - The flying leads from cable of the kit are to be connected to the customer's PLC or warning signal light, +24VDC. (black and white wires)
- Adapter: Splitter – M12 (M) x 2 M12 (F) - 3 ft. [1 m] whip cord length (Part number: LE00M12WYE1M)
- Open connector on splitter
 - Connect PulsaJet cable; AA250 cable; or extension cable to this connection.

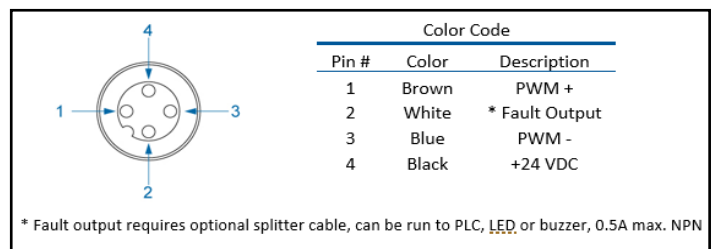

**Alarm output Signal Kit
040TS04000054W0**

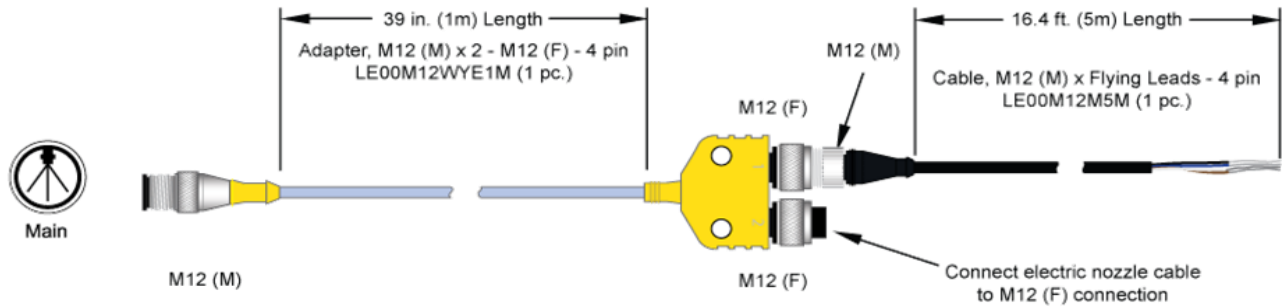

12.13 ALARM OUTPUT CABLE KIT

The 1750+ and 2150+ offer a feature to provide a signal when an error has occurred during operation. This is wired as shown in the table below. To use this feature, you need to have our optional splitter cable kit.

- Panel connection: Main and T. int.
- Kit number: 040TS04000064W0
- Adapter: Splitter- wye, M12, 4 pole, trunk = male M12 1m whip, 2 branches x M12 female coupling nuts, TPU, parallel wiring. (Part number: LE00M12WYE1M)
- Cable: Main, M12 (M) x Flying Leads - 16. 4 ft. [5 m] cord length, bare leads, M12 4 pin (M), 4 wire. (Part number: LE00M12M5M)
 - Connects to one connector on splitter
 - The flying leads from cable of the kit are to be connected to the customer’s PLC or warning signal, +24VDC. (black and white wires)
- Open connector on splitter
 - Connect PulsaJet cable; AA250 cable; or extension cable to this connection.

Color Code		
Pin #	Color	Description
1	Brown	PWM +
2	White	* Fault Output
3	Blue	PWM -
4	Black	+24 VDC

Fault Output signal max. 30v/1A NPN

**Level Switch Cable Kit
040TS04000064W0**

Level Switch cables

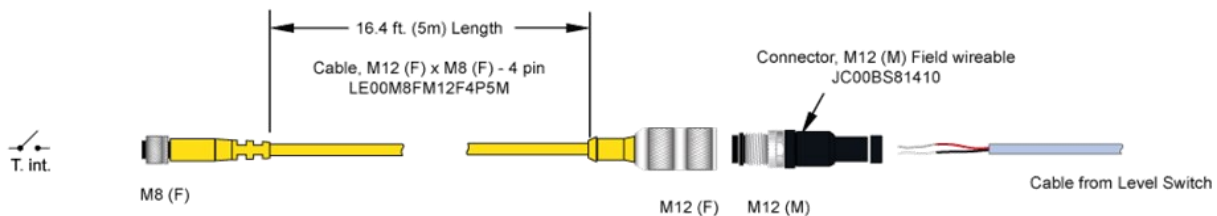

Fault Output cables

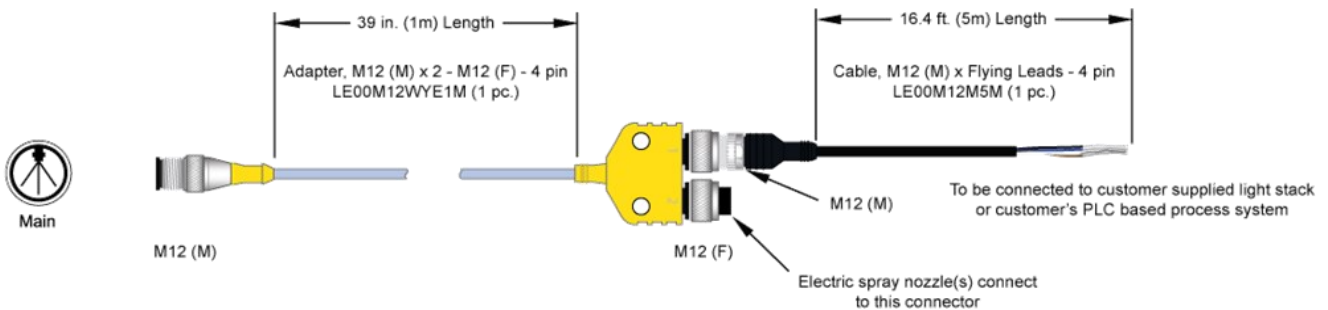

12.14 EXTENSION CABLE

If longer length cables are required, an extension cable is available that can be used to go between the nozzle cable and the junction block or the junction block cable and the system. This cable can also be used to extend the trigger device cable lengths.

This cable can be used to go between the nozzle cable and the junction block or the junction block cable and the system or extend the trigger device cable lengths. When using to extend electric nozzle cables, connect electric nozzle cable to M12 (F) connector. When using to extend electric nozzle cables, M12 (M) connects to “Main” connector on the control panel or junction block. When using to extend sensor cables, connect M12 (F) connector to “Trig” connector on the “Trig” Control Panel. When using to extend sensor cables, connect M12 (F) connector from sensor cable to M12 (M) connector of the extension cable.

Note: Due to voltage drop we recommend keeping the cable length to a reasonable length. Never attempt to chain more than four (4) cables together. Electric spray nozzle speed and performance will suffer.

- Part number: LEXXSD4FD4M005P
- Connect to Main or Trig on control panel
- Cable: 16.4 ft. [5 m] cord length
- Connector – M12 4 pin female
- Connector – M12 4 pin male

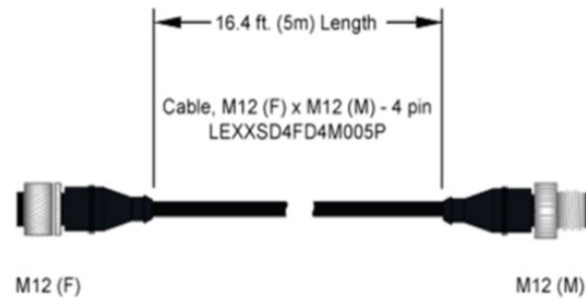

12.15 INPUT SIGNAL

Optional Input signal offering consists of a cable with connector and flying leads to be connected to the customer's conditioned 4-20 mA signal to remotely control the PWM (Pulse Width Modulation) feature of the spray control panel. This will allow the duty cycle to adjust according to the input signal. 4mA corresponds to a 0% duty cycle and 20 mA corresponds to a 100% duty cycle.

For the spray indicator digital output (DO2), wire to pins 1 and 2 (brown and white wires). This output is active only when the system is triggered, it can be sent to a PLC for spray verification.

ASSEMBLY SPECIFICATIONS

- Panel connection: 4-20mA
- Part number: LE00M8M5M
- Cable: 16.4 ft. [5 m] cord
- Flying Leads
- Connector – M8 4 pin male
- Connect to “4-20mA” connection on control panel

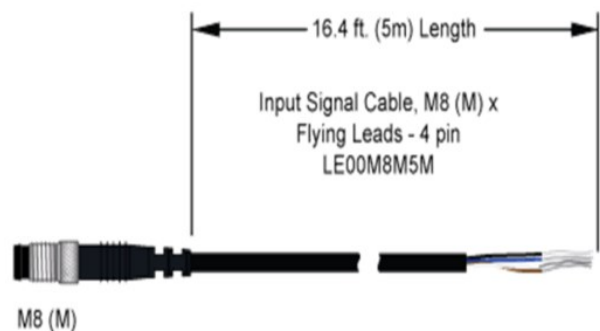

		Color Code	
Pin #	Color	Description	
1	Brown	+24 VDC	
2	White	DO2	
3	Blue	0 VDC	←
4	Black	4-20mA	

Note: If your 0VDC is coming from a power supply outside of our panel (PLC), connect it to this wire – Pin #3

12.16 LEVEL SENSOR INPUT

A level switch (any normally open or normally closed float switch) can be wired to the system, so when the tank level drops below a certain level, an alarm will be shown on the HMI.

Wire the level sensor/float switch to the panel utilizing the cable shown below. You will only use the black and blue wires (dry contacts - polarity not important), carefully cut back and tape the brown and white wires. Run the cable back to the spray control panel and plug into the port labeled "T. Int."

Activate level sensor option, go to settings in the HMI then "Tank level" and turn on.

Specifications:

- Part number: LE00M8F5M.
- Panel connection: T. int. (Software - DI2+DI4)
- Cable: 16.4 ft. (5 m) cord length
- Flying leads
- Connector end - M8 4 pin female
- Cable, M8 Female, 4 pole, bare leads, 5 meter

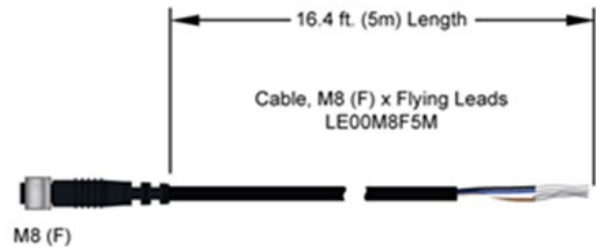

Color Code		
Pin #	Color	Description
1	Brown	+ 24VDC (not used) not used
2	White	not used
3	Blue	0 VDC
4	Black	DI1

12.17 TRIGGER DEVICES OVERVIEW

Trigger Devices				
ID	Trigger Method	Part Number	Cable Length	Description
1	Customer Supplied	040TS04000056W0	5 m	Trigger cable - M12 female, 4 pole, bare leads
2	Hand Pendant	040TS04000057W0	5 m	Hand-held trigger device
3	Foot Switch	040TS04000130W0	5 m	Foot switch trigger device
4	Object Sensor - Photoelectric	040TS04000014W0	5 m	Detectable Distance - 0.79 to 35.43 in., mounting bracket included, IP67 Rating, NPN output
5	Object Sensor - Thru-Beam	040TS04000028W0	5 m	Detectable Distance - 65.6 ft, mounting brackets included, IP67/IP69K rating, NPN output
6	Laser Sensor - Short Distance	040TS04000135W0	5 m	Detectable Distance - 0.98 to 3.54 in., mounting bracket included, IP68/ IP69K rating, NPN/ PNP output
7	Laser Sensor - Long Distance	040TS04000087W0	5 m	Detectable Distance - 1.38 to 19.69 in., mounting bracket included, IP68/ IP69K rating, NPN output
8	Proximity Sensor	040TS04000118W0	5 m	Ferrous metals, 10 mm (0.39 in.) detectable distance, NPN Open collector, IP67 rating
9	Color Sensor	040TS04000179W0	5 m	Full-Spectrum color, detects color/brightness/surface finish/intensity, NPN/PNP, IP65/ IP67 rating, 1.18 to 19.69 in. detectable distance
10	Trigger Adapter - Dual Channel	070TS07000051W0	5.3 m	Single Trigger Splitter for Dual Channel Systems

NOTE: CONTACT A SALES ENGINEER TO DETERMINE WHICH SENSOR BEST FITS YOUR APPLICATION AND SYSTEM CONFIGURATION.

WARNING
Trigger device IP rating only applies when all cables are properly connected and secure

DESCRIPTION:

Spray Control System (SCS) Series
Trigger Devices



Spraying Systems Co.
Spray Nozzles and Accessories
P.O. Box 7900 - Wheaton, IL 60187-7901

REVISION NO.	1	Data Sheet No.	
REFERENCE:	1	SCS Series - Trigger Devices	
SHEET:	1 OF 1	DWG SIZE:	B

SPARE AND REPLACEMENT PARTS

Repair Kit	Part Number
Repair Kit includes: 1750 Repair Kit, 2300, HMI, Fuse, LED, Comm Cable, Tamper-Proof Torx Driver, DB9 Com Cable	070TS07000086W0
Accessory Kits	Part Number
Photoelectric Object Sensor: Object Sensor Kit, Trig, 5 m cord length, M12 3 pin (F)	040TS04000014W0
Proximity Sensor: Detects all metals 10mm max. sense dist., 24vdc, NPN outputs N.O./N.C., shielded, IP67, 5m cable wired	040TS04000118W0
Thru-Beam Sensor: Trig, 5 m cord length, connector—M12 3 pin female, IP67/IP69K rating, NPN output	040TS04000028W0
Laser Sensor (Short): mounting bracket, accurate short sensing distances of 25 to 90 mm, std. detectable deviation 1.5-3.0mm, NPN/PNP open collector, 24Vdc, M12 3 pin male connection, 5m cable	040TS04000135W0
Laser Sensor (Long): 5m cable, and mounting bracket, 24Vdc, NPN. IP68/ IP69K.	040TS04000087W0
Level Switch Cable Kit: Main/T. int., M12 (M) x 2 M12 (F), 1 m whip cord length. Cable Kit, Level Switch to Alarm Output Cable, 24VDC	040TS04000064W0
Alarm Output Signal Kit: Cable Kit, SCS Series Alarm Output	040TS04000054W0
Accessory Cables	Part Number
Electric Nozzle Cable: Main, 3 m cord length, Mini DIN, M12 3 pin male	LE00M12MMDIN3MU
PulsaJet Nozzle Cable: Main, 3m cord length, M8 3 pin female, M12 3 pin male	LEXXS3M83F030P
Extension Cable: Main/Trig, 5 m cord length, M12 4 pin (F/M)	LEXXS4FD4M005P
Trigger Cable: Trig, 5 m cord length, flying leads, M12 4 pin female	LE00M12F5M
Trigger Interlock: T. int. 5 m cord length, flying leads, M8 4 pin female	LE00M8F5M
Level Sensor Input: Cable, M8 Female, 4 pole, bare leads, 5 meter	LE00M8F5M
Input Signal: M8 4 pin male, 4-20mA, 5 m cord length, flying leads	LE00M8M5M
Level Switch Cable Adapter: Splitter, wye, M12, 4 pole, trunk = male M12 1m whip, 2 branches x M12 female coupling nuts, TPU, parallel wiring	LE00M12WYE1M
Alarm output Signal Adapter: Splitter, wye, M12, 4 pole, trunk = male M12 1m whip, 2 branches x M12 female coupling nuts, TPU, parallel wiring.	LE00M12WYE1M
Level Switch Cable: Main, M12 Male, 4 pin, 4 wire, bare leads, 5 meter	LE00M12M5M
Alarm output Signal Cable: M12 Male, 4 pin, 4 wire, bare leads, 5 meter.	LE00M12M5M
Accessory Switches	
Hand Trigger Pendant: hand trigger pendant, selector switch and button, M12 female 4 pole, 5 meter cable	SW001550M12HT
Foot Switch: Momentary on switch, M12 (F) connector, 5 m cable length	040TS04000130W0



© 2024 All rights reserved. Printed in the U.S.A.

Under copyright laws, this manual may not be reproduced in any form, in whole, or in part, without prior written permission from Spraying Systems Co.[®]. This revision supersedes all previous revisions. Every effort has been made to ensure that the information in this manual is accurate at the time of printing.

However, Spraying Systems Co. assumes no liability for errors or omissions and reserves the right to make changes without notice to any products described herein to improve reliability, function, or design. Other company and product names may be trademarks of their respective companies.

Warranty is one (1) year on non-wear parts from ship date. Wear items are covered for manufacturing defect only for a period of one (1) year. Wear items include, but may not be limited to, Liquid pump and Liquid regulator. Seller warrants that its products will conform to and perform in accordance with the products' specifications.

Seller warrants that the products do not infringe upon any copyright, patent, or trademark.

THE FOREGOING WARRANTIES ARE IN LIEU OF ALL OTHER WARRANTIES, EXPRESS OR IMPLIED, INCLUDING, BUT NOT LIMITED TO, THOSE CONCERNING MERCHANTABILITY AND FITNESS FOR A PARTICULAR PURPOSE.



Spraying Systems Co.[®]
Experts in Spray Technology

North Avenue and Schmale Road, P.O. Box 7900, Wheaton, IL 60187-7901

Tel: 1.800.95.SPRAY Intl. Tel: 1.630.665.5000
Fax: 1.888.95.SPRAY Intl. Fax: 1.630.260.0842

www.spray.com

