

AutoJet[®] 2150+ Spray Control Panel

OWNER'S MANUAL

AutoJet[®]
TECHNOLOGIES



Spraying Systems Co.[®]
Experts in Spray Technology

ML002150PLUS
spray.com

TABLE OF CONTENTS

1. Preface	3	9. Speed/Encoder (Option)	39
1.1 Important	3	9.1 Speed/Encoder	39
1.2 How To Use This Manual	3	9.2 Encoder Selection	40
2. Safety	3	9.3 Encoder Spare Parts	41
2.1 General Safety Information	3	10. Flow Meter (Option)	42
2.2 Unpacking The System	4	10.1 Flow Meter Settings	42
3. 2150+ Overview	5	10.2 Assembly Specifications	43
3.1 System Features	5	10.3 Flow Meter Spare Parts	44
3.2 System Specifications	5	11. Faults And Alarms	44
3.3 Precision Spray Control (PSC)	6	11.1 Faults And Alarms Settings	44
3.4 Position Or Mount The System	7	12. Maintenance And Troubleshooting	45
3.5 Plug And Spray Connections	7	12.1 Settings	45
3.6 Remote Connection	8	13. Diagnostics	47
3.7 Screen Buttons And Icons	8	14. Trigger Devices And Accessories	47
3.8 HMI Operations—Set Spray Parameters	9	14.1 Electric Nozzle Cord Set	47
3.9 Recipes	9	14.2 Trigger Cable	48
4. 2150+ Home Screen	10	14.3 Photoelectric Object Sensor	48
4.1 Home Screen—Channel A and B	10	14.4 Color Sensor	49
4.2 Home Screen Options	11	14.5 Proximity Sensor	49
4.3 Purge And Clean	12	14.6 Trigger Interlock	49
5. General Settings	13	14.7 Foot Switch	49
5.1 Settings Screen	13	14.8 Hand Trigger Pendant	50
5.2 User Management Settings	14	14.9 Thru-Beam Sensor	50
5.3 User Groups	16	14.10 Laser Sensor (Short)	51
6. Supplying Air To The System	17	14.11 Laser Sensor (Long)	51
6.1 Adjustments and Operations	17	14.12 Fault Output Signal	51
7. Application Settings	18	14.13 Fault Output cable Kit	52
7.1 Spray Nozzle Settings	18	14.14 Extension Cable	53
7.2 Configuration	22	14.15 Input Signal	53
7.3 Configuration Timing Tab Settings	22	14.16 Level Sensor Input	54
7.4 Spray Timing Modes	23	14.17 Trigger Devices Overview	54
7.5 Fixed Spray Time	24	15. Faults And Troubleshooting	55
7.6 Variable Spray Time	26	15.1 Internal Components	58
7.7 Fixed And Variable Spray Distance	29	16. Ethernet IP Manual (Optional)	59
7.8 Configuration Setpoint Tab Settings	30	16.1 Studio 5000 Import Example	59
7.9 Recipe Settings	31	16.2 Loading the Registered EDS File	61
7.10 Duty Cycle	33	16.3 Ethernet IP Address List: Read Address	63
7.11 Trigger	35	16.4 Ethernet IP Address List: Write Address	64
7.12 Tank Level Sensor	36	16.5 BIT Numbers, Faults, and Their Descriptions	65
8. Pressure Sensor (Option)	37	17. Spare And Replacement Parts	66
8.1 Liquid Pressure (Pressure Sensor)	37		
8.2 Pressure Sensor Spare Parts	38		

SECTION 1

PREFACE

1.1 IMPORTANT

The AutoJet® 2150+ Spray Control Panel and all components are produced, tested, and checked at the factory. The system can be dangerous if used incorrectly. Read this manual carefully and pay attention to any safety instructions.

Operators must always follow the general safety instructions in the working area and aim to prevent accidents.

The manufacturer reserves the right to make changes in standard construction without prior notification.

Images and diagrams in this manual may not be exact representations of the system configuration.

1.2 HOW TO USE THIS MANUAL

This manual is intended to be a source of information for the operators and technicians who may be installing, interacting with, or servicing/maintaining Spraying Systems Co.® systems and components.

This manual contains important safety warnings, installation instructions, operating instructions, troubleshooting, and maintenance information.

ICONS



WARNING: The User can be seriously injured, damage their health, and/or seriously damage the system.



CAUTION: Product, process, or environment can be damaged or be in danger if the instructions are not followed correctly.



ATTENTION: Supplementary information for the user that draws attention to possible problems.

SECTION 2

SAFETY

2.1 GENERAL SAFETY INFORMATION

READ AND FOLLOW INSTRUCTIONS

All safety related and operating instructions should be read before the system is operated. Follow all operating instructions.

SERVICING

Do not attempt to service this system unless you have been trained or authorized to conduct repairs. Only authorized and qualified service personnel should attempt to service this system. Service by unauthorized personnel will void any warranties.



WARNING: Before performing any maintenance, make sure electrical power is off and that any air and liquid pressure is bled from the system.

REPLACEMENT PARTS

This system has been designed with components that work together to provide the best system performance. When replacement parts are required, only Spraying Systems Co.® recommended components should be used to maintain proper system operation, electrical and pneumatic safety. The use of any unauthorized replacement parts will void any warranties.

UNINTENDED USE

Use of Spraying Systems Co.® equipment in ways other than those described in the documentation supplied with the equipment may result in injury to persons or damage to property. Examples of unintended use of equipment:

- Using incompatible materials or damaged parts
- Making unauthorized modifications or using unapproved auxiliary equipment
- Removing or bypassing safety guards or interlocks
- Operating equipment in excess of maximum ratings

REGULATIONS AND APPROVALS

Make sure all equipment is rated and approved for the environment in which it is used. Any approvals obtained for Spraying Systems Co.® equipment will be voided if instructions for installation, operation, and service are not followed. All phases of equipment installation must comply with federal, state, and local codes.

PERSONAL PROTECTIVE EQUIPMENT

Spraying Systems Co. strongly recommends the use of appropriate safety equipment when working in potentially hazardous environments or with potentially hazardous chemicals. This safety equipment includes, but is not limited to, the following:

- Protective hat, chemical-resistant safety gloves and apron
- Safety glasses/face shield, long sleeve shirt and long pants

Users of this product should never place themselves in the path of the resulting spray. Users should consult and follow the recommendations of the Safety Data Sheet (SDS) of any chemical or fluid sprayed using this system.

PRESSURIZED SYSTEMS

It is important to recognize proper safety precautions when using a pressurized spray system. When dealing with pressure applications, the system pressure should never exceed the lowest rated component. Always know the system and all component capabilities, maximum pressures, and flow rates.



WARNING: Fluids under pressure can penetrate skin and cause severe injury.



ATTENTION: Always remember to carefully read the chemical manufacturer's labels and SDS and follow all directions.

WARNING OF SHOCK HAZARD

To reduce the risk of electric shock, do not open the cover on electrical control panel. For service contact Spraying Systems Co.® at 1-866-321-2250.



WARNING: Plug panels into a GFCI outlet.



WARNING: To prevent injury, avoid contact with potentially hot parts. Components can cause severe burns. Do not aim the spray at any person or part of the body. Do not place any part of your body in the spray pattern.

2.2 UNPACKING THE SYSTEM

The system components come carefully packaged to protect them from damage. Use caution when opening the crate. The crate will contain all parts needed to install the unit. Parts of the unit may be wrapped in bubble wrap. Remove all of the packaging material wrapping the system. Once unpacked and removed from the crate, the system is ready for installation and connection.



CAUTION: The packaging may contain exposed cables, hoses, or other components. Always exercise caution when opening boxes to avoid accidental damage or slicing of various components.



2150+ OVERVIEW

The 2150+ is the advanced level offering in the Spray Control System (SCS) Series. It provides ON/OFF timing control and liquid pressure control for both electrically- and pneumatically-actuated spray nozzles. The system comes in a variety of design configurations depending on the spray application, therefore, you may or may not have all the features described in this owner's manual.

2150+ VERSIONS

- Single/Dual Channel, 48V nozzle driver (Standard)
- Single/Dual Channel, 24V nozzle driver (Optional)
- High Capacity, 48V (Standard) nozzle driver/24V nozzle driver (Optional)

3.1 SYSTEM FEATURES

SPRAY CONTROL

- Nozzle compatibility: air- or electrically-actuated, hydraulic or air atomizing nozzles.
- Timing modes: Fixed/Variable spray time, and Fixed/Variable spray distance (Repeat function available for all four modes).
- Pressure and flow monitoring: Pressure sensor and flow meter accessories allow for real-time monitoring of current spray parameters.
- Recipe based timing: Create and store up to 20 user programmed recipes. (Optional Add-on feature)

PLUG AND SPRAY COMPATABILITY

Plug and Spray provides quick electrical hook-up for all nozzles, an Air Control Package (ACP), triggers, and any other compatible SCS Series accessories - including a level sensor, pressure sensor, flow meter and line speed encoder. An Ethernet bulkhead is included in the Plug and Spray array.

3.2 SYSTEM SPECIFICATIONS

- Spray control panel weight: 37 lbs. (16.3 kg) approximate
- Max nozzle distance from panel: 15 m (50 ft)
- *For longer distances, consult with SSCO Engineering, a larger gauge wire/ cable will be needed.*
- 1-100% duty cycle adjustment for electric spray nozzles.
- Input for sensor or remote trigger/relay dry contact
- Independent timing ranges for spray and delay adjustable from 0 to 9,999.99 seconds
- Max. no. of 10000AUH-03 PulsaJet Spray Nozzles: 16 per channel
- Max. no. of 10000AUH-10 PulsaJet Spray Nozzles: 5 per channel
- Max. no. of 10000AUH-0050 PulsaJet Mini Spray Nozzles: 8 per channel (48V driver version only)

SPECIFICATIONS:

- Power input: 120VAC, 60 Hz, 8.8A, 1-Ph
 - Global compatibility multi-voltage power cords available.
 - Power ON/OFF switch-Power on indicator light
 - Power cord, 6ft (2m) length
- 7" HMI Touch Screen control and display
 - HMI window kit (optional add-on)
- Wall-mountable stainless steel enclosure, washdown with door closed
- Built-in Wi-Fi wireless access point.

DIMENSIONS

- Width: 16 inches
- Depth: 10 inches
- Height: 18.5 inches

STANDARD ENVIRONMENTAL SPECIFICATIONS:

- To be installed indoors
- Min. ambient temperature: 41°F
- Max. ambient temperature: 104°F
- Max. humidity: 90%
- Not explosion proof (non-Ex)
- Height above sea level: <3,280 feet

3.3 PRECISION SPRAY CONTROL (PSC)

The PulaJet® automatic spray nozzle is an electrically-actuated hydraulic atomizing nozzle. This nozzle sprays the product in a controlled way using a Pulse Width Modulation (PWM) algorithm to control the sprayed amount without affecting the spray angle. PWM is the fundamental control principle that allows a significant reduction in flow by regulating the relationship between the on/off times that the nozzle operates.

Short pulses of off-time and longer pulses of on-time produce a spray pattern that appears continuous, but actually reduces the overall flow delivered to the target surface. This provides better flow control with larger spray tips that are less prone to clogging. The droplet size is affected by the pressure of the liquid. With PSC, the droplet size and spray angle are independent of the liquid flow because the nozzle can work at the same liquid pressure for variable liquid flows.

PSC involves switching the spray nozzle on and off repeatedly at a controlled rate, called the modulating frequency. The modulating frequency is the number of times the nozzle is switched on and off in one second and is measured in Hertz (Hz). If a spray nozzle is switched on and off 10 times per second, the modulating frequency is 10 Hz. The time from when the nozzle turns on to the next time the nozzle turns on is called the period, in this case 1/10th of a second.

Within a single period, the nozzle is switched on, then off. The time that the nozzle is on, divided by the total time of the period, gives a percentage which is called the duty cycle. For example, if the period is 0.10 seconds, and the nozzle is on for half of that time, then the duty cycle is 50%. For the same period, if the nozzle is on for 0.08 seconds then the duty cycle is 80%. Therefore, at an 80% duty cycle, the flow will theoretically be 80% of the maximum flow rate (= 100% flow rate) at a given pressure for the nozzle. Using PSC, the flow rate for a spray application can be easily controlled without the need to adjust the spray pressure or spray tip.

SINGLE CHANNEL

- 48V nozzle driver (Standard)
 - 48Vdc/10A power supply
- 24V nozzle driver (Optional)
 - 24Vdc/10A power supply

DUAL CHANNEL

- 48V nozzle driver (Standard)
 - Two (2) 48Vdc / 10A power supplies
- 24V nozzle driver (Optional)
 - Two (2) 24Vdc / 10A power supplies

HIGH CAPACITY

- 48V nozzle driver (Standard)
 - Two (2) 48Vdc / 10A power supplies
- 24V nozzle driver (Optional)
 - Two (2) 24Vdc / 10A power supplies

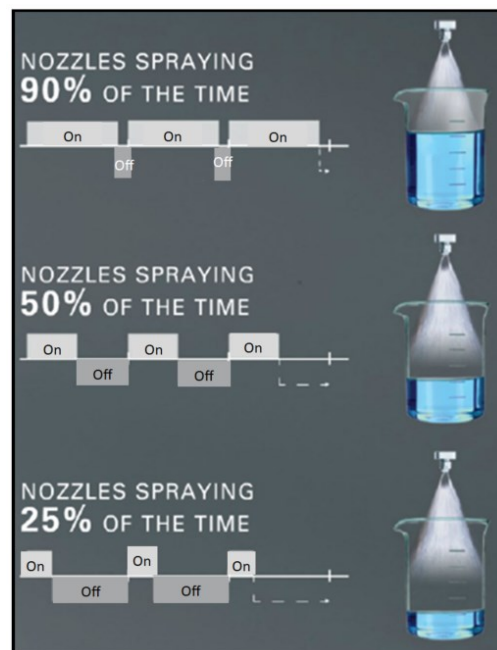

3.4 POSITION OR MOUNT THE SYSTEM

The system should be placed in a convenient location near the spray application. A properly grounded power outlet must be easily accessible.

—Determine if the unit will be free-standing or wall mounted.

CONTROL PANEL ONLY VERSION

Note: The Control Panel Only version should be wall mounted.

Install wall anchors that are designed to support at least 25 lbs., according to the anchor manufacturer’s specifications. The mounting holes are on 14.5" centers and are made for 0.5" screws.

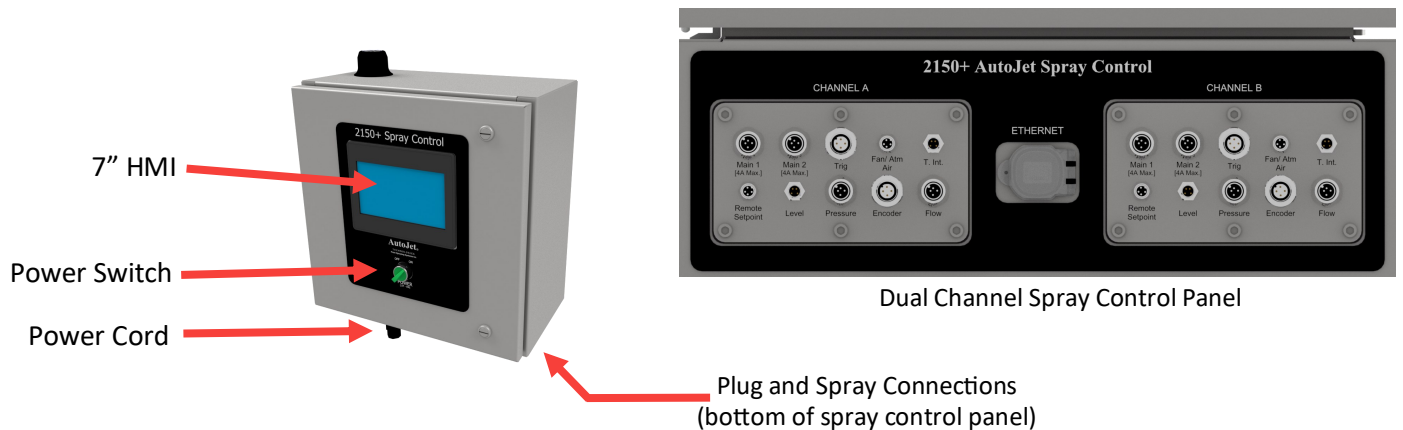

3.5 PLUG AND SPRAY CONNECTIONS

All the connections are the same as the full system. Located on the bottom of the panel the connections are as follows.

Plug provided power cord into the existing whip cord at the bottom of panel.

- **Main** - Used for the output connection for all electric spray nozzles and cylinder air.
- **Trig** - The input connection for the system trigger or sensor.
- **Fan/Atm Air** - The output connection for the fan/atomizing air.
- **T. int.** - Used for the optional trigger interlock or level switch input.
- **Remote Setpoint (Duty Cycle)** - 4-20 mA, Analog input is accessible through this connection.
- **Level** - Used for Tank Level sensor. Connect the sensor to the “Level” connection. On the HMI, go to Application Settings to activate the level sensor settings.
- **Pressure** - Liquid Pressure settings require an active pressure sensor connection to the panel. When connected, the input settings are to be calibrated to match the specifications of the pressure sensor. Connect the pressure cable to the “Pressure” connection.
- **Encoder** - (Speed) settings require a connected line speed encoder. Connect the sensor to the “Encoder” connection. On the HMI, go to Application Settings to activate the encoder.
- **Flow** - Connect the unit and then connect the “Flow” meter cable to the panel. Set the input values to match the specifications of the flow meter.



Channel A and Channel B bulkheads (bottom of 2150+)

3.6 REMOTE CONNECTION

Users can connect to the 2150+ with a mobile device via Wi-Fi to create an access point. Once set-up is complete, you can adjust settings, view alarms, troubleshoot, review maintenance schedules, and more on the connected mobile device. The 2150+ Preventative Maintenance (PM) scheduler allows the user to set various maintenance reminders by months or number of cycles. An alarm will appear on the HMI when the maintenance is due.

SMART DEVICE CONNECTION

1. Go to the Play Store or Apple App store and download a VNC viewer app, such as RealVNC Viewer.
2. Power on the 2150+ (if system is not already on).
3. In Wi-Fi settings on your mobile device, locate the Wi-Fi SSID: SSCO_PJNXXXX (each project number will be specific per device and given to owner). Select connect and enter the default password of SSCO_SCS.

Note: There is a chance that your network administrator blocks this type of connection.

4. Finally, open VNC Viewer and connect to the 2150+ at: 192.168.0.20

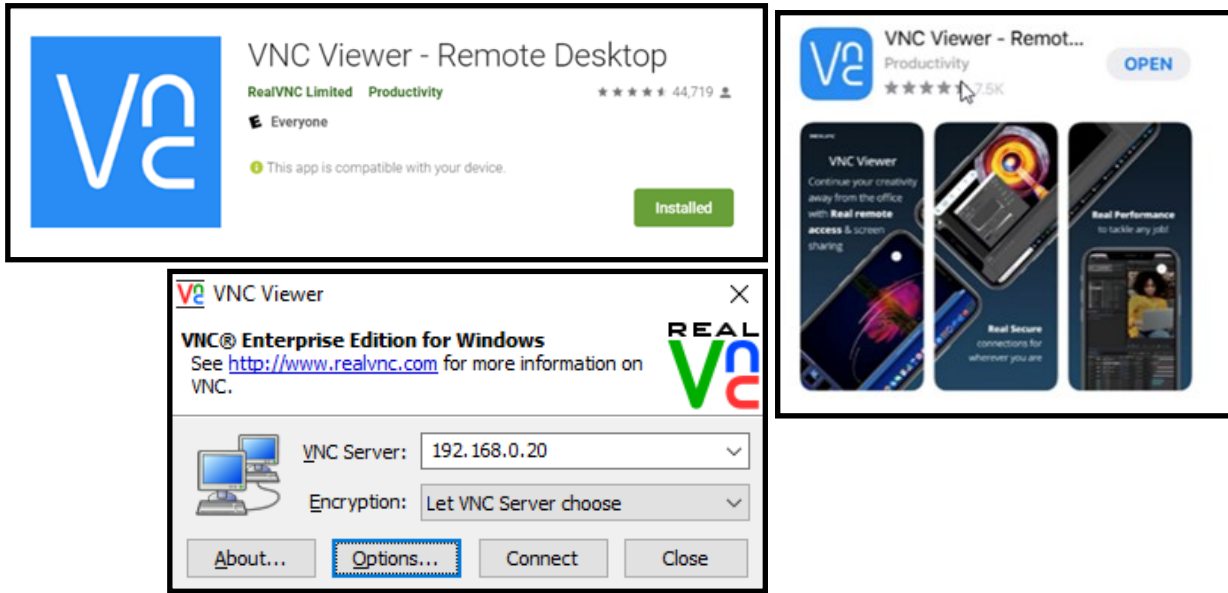

3.7 SCREEN BUTTONS AND ICONS

TOP BAR STATUS INFORMATION	
	Navigate to about screen.
	Recipes
	Displays current system status.
	Reset Alarm

SCREEN BUTTONS	
	Field is editable
	Toggled On
	Toggled Off
	Standby or Run
	Trigger

SIDE BAR NAVIGATION	
	Navigate to home screen.
	Navigate to settings screen.
	Navigate to diagnostics screen
	Navigate to alarms screen, turns orange with an active alarm present.
	Switch to a different user.

3.8 HMI OPERATION—SET SPRAY PARAMETERS

1. Set the system to manual mode. Disconnect the nozzles. Set all pressure regulators to 0. Turn on the main air pressure and increase liquid pressure gradually to flush the system. Everything is now flushed except for the nozzles.
2. Connect the nozzles, set the pressure regulators to the required pressure and check for leakage.
3. If the nozzle type isn't set, go to the *Spray Nozzle Settings* section of this manual.

TO START THE SYSTEM

1. Verify the system status is in "Run" mode (top bar, right corner).
2. If not, press "run" until the system is in "RUN" mode.
3. Be sure a recipe is selected. If you have purchased the optional software upgrade and the desired PWM setpoint is set in the recipe (between 1% and 100% depending on the application).

3.9 RECIPES

A recipe is a pre-configured set of timing and spray parameters designed to help transition quickly from one application to the next. The 2150+ is capable of storing up to 20 user created recipes.

By default, the 2150+ control panel has simple timing to operate PulsaJet electric spray nozzles. The recipe function can be added anytime by entering an unlock code as shown below. A recipe can be loaded by selecting it from the dropdown menu and clicking "Apply" to transfer the settings to the 2150+. If you edit the currently selected recipe, you must press "apply" again for the changes to be applied.

Preprogrammed recipes can be accessed quickly from any screen by selecting the recipe section of the top bar. The recipe settings sections contains four tabs. The drop down list near the top of the page allows you to select which recipe you would like to view, edit, or apply as the current spray parameters.

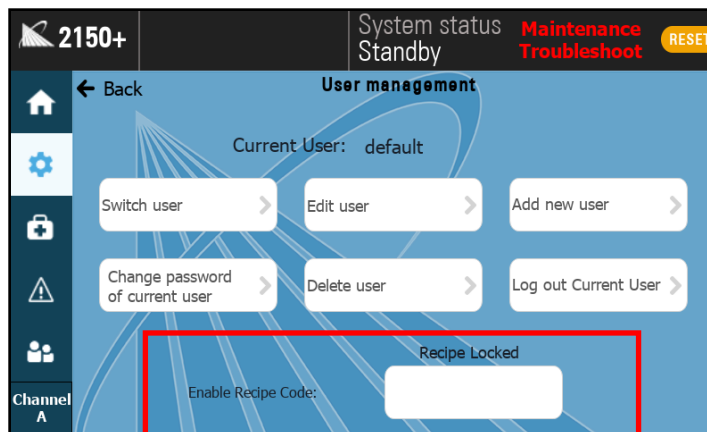

Enter recipe code in the box at the bottom of the screen

2150+ HOME SCREEN

4.1 HOME SCREEN—CHANNEL A AND B

The 2150+ is available in either a single or dual channel configuration. In a single channel system, there will be no channel name or designation shown on the home screen. In a dual channel system, the Channel A label will be visible in the lower left corner of the screen and under the top bar.

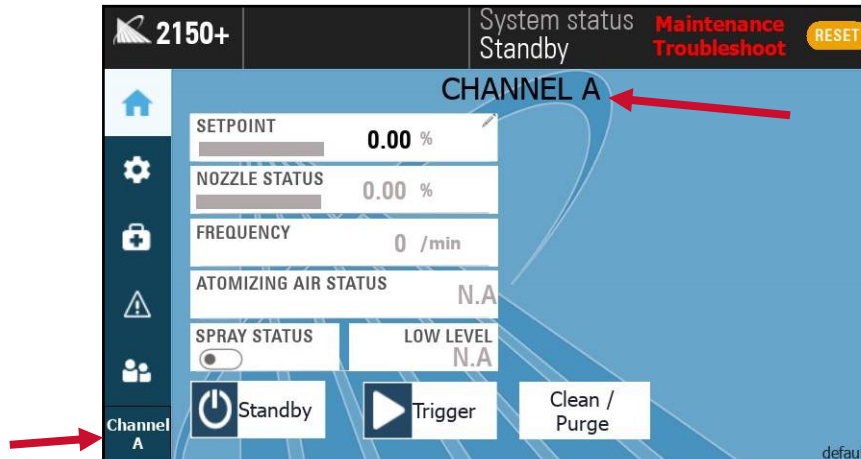

Home screen, Channel A for a dual channel 2150+

In a dual channel system, Channel B is also available for configuration. To access Channel B, press the *Channel A* labeled box in the lower left-hand corner of the screen. *Channel B* appears with a different color home screen background color to allow for easy identification of the currently selected channel.

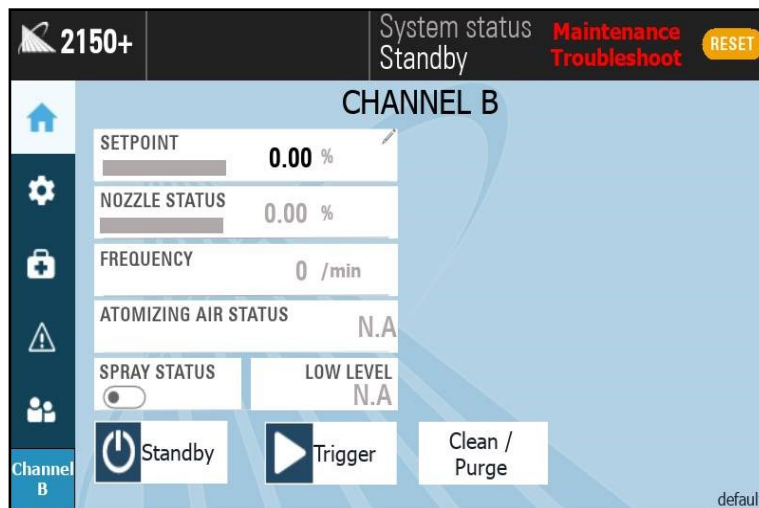

Home screen, Channel B for a dual channel 2150+

Selecting the 2150+ icon in the top left-hand corner of the screen will bring up the *About* screen for the spray control panel.

4.2 Home Screen Options

The home screen at the top and side bars will always be visible and accessible.

Setpoint: Displays the configurable mode in the application you are set in.

Nozzle status: Displays the current nozzle spray status as a percentage of the maximum flow rate.

Atomizing air status: Atomizing Air Status and spray status are read-only representations of the current status. Adjust atomizing air in settings, and toggle the spray status by using the run or trigger buttons.

Spray status: Shows whether the nozzle is currently spraying or not.

Frequency: is read only representations of the current status and displays the actual cycles per minute.

Low level: will display if a level sensor is connected and configured for the 2150+.

Liquid pressure, remote setpoint, line speed (duty cycle), flow rate, and application rate configurations are based on the current spray parameters (if you have these applications) and are read-only values.

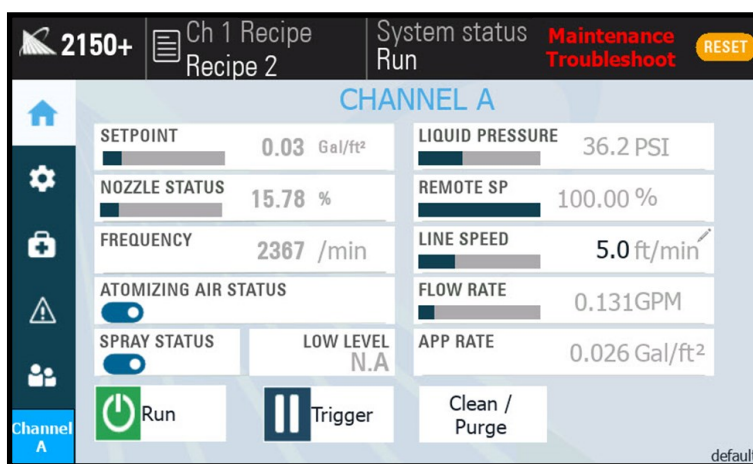

2150+ Home Screen

STANDBY/RUN

Using this Toggle button, you can swap between Run and Standby states.

- Run: The system will spray if it is triggered.
- Standby: The system will stop spraying and will not react to a new trigger signal.

If the system is busy spraying, it will finish the “follower” for the air output to cleanly stop spraying.

TRIGGER

The trigger button is only shown if the trigger source has been set to “Button on home screen” in “Trigger settings”.

Depending on the settings, you will have:

- Fixed spray mode, Momentary button (single shot mode): starts a spray when clicked.
- Variable spray mode, Toggle button: starts & stops a spray when clicked.

CLEAN/PURGE: Access or trigger the clean and purge cycle settings.



4.3 PURGE AND CLEAN

Purge and clean cycles can be toggled on or off with their labeled On/Off indicators at the bottom of the screen. A blue indicator with the dot on the right side shows the currently selected and active cycle.

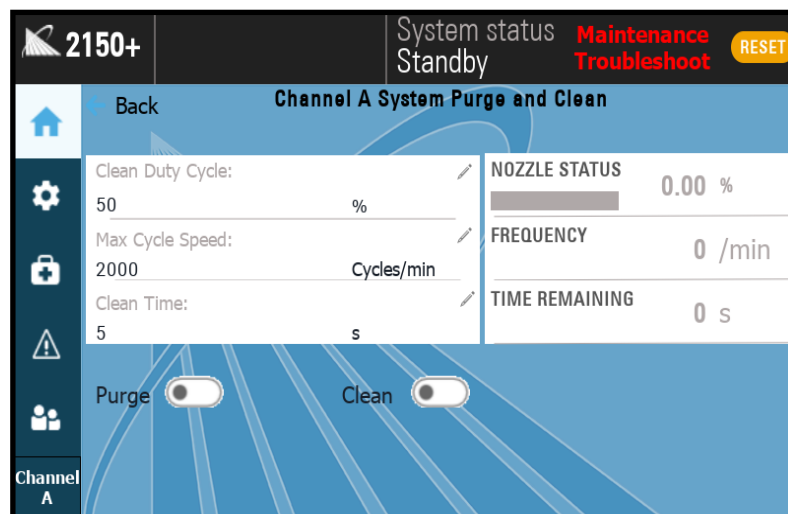

Purge and Clean settings screen

PURGE

The purge cycle is commonly used to empty the fluid lines of liquid, or as an additional way to drain a tank or pressure pot.

The purge cycle automatically sets the nozzle duty cycle to 100% (fully open) and requires the operator to manually turn the cycle on or off using the labeled indicator. The cycle will continue until it is manually turned off. The other values are not editable while the purge cycle is active.

CLEAN

The clean cycle is commonly used to clear a nozzle that appears to be clogged and requires the operator to set three editable values.

These values include:

- Clean Duty Cycle — Set between 1–100%
- Max Cycle Speed—Set between 60–5,000 cycles/minute
- Clean Time—Set between 1–250 seconds



GENERAL SETTINGS

General settings relate to the spray control panel itself and how operators interact with the 2150+.

5.1 SETTINGS SCREEN

The 2150+ allows operators to manage users and user settings, change the language (where applicable), view system information, and view the activity log.

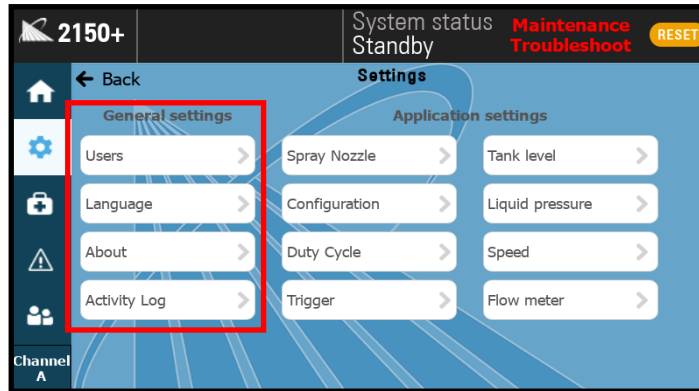

Settings screen

LANGUAGE

Here you will be able to change the language of the user interface text if available.

ABOUT SCREEN

This screen displays information about the system. You can find the following information in the about screen:

- Spray controller serial number
- Spray controller software version and revision number
- Spray controller/panel uptime
- User interface panel software version/hardware description
- Current date/time

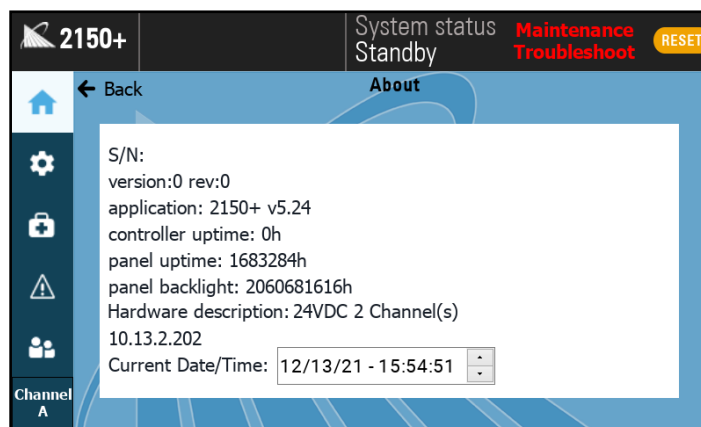

ACTIVITY LOG

The 2150+ tracks all changes to critical settings and records which users make these changes; this information is available in the activity log. Users within the User Group cust_admin can view these activity reports on the 2150+ or export the activity report via a USB stick.

Record ID	Timestamp	Username	Operation	Information
1	12/13/21 - 08:29:38	default	WRITE TAG	a2300/analogInput A11 function:0
2	12/13/21 - 08:29:38	default	WRITE TAG	a2300/digitalOutput D01 function:5
3	12/13/21 - 08:29:38	default	WRITE TAG	a2300/digitalOutput D03 function:2
4	12/13/21 - 08:29:38	default	WRITE TAG	a2300/digitalOutput D01 invert:0
5	12/13/21 - 08:29:38	default	WRITE TAG	a2300/digitalOutput D02 invert:0
6	12/13/21 - 08:29:38	default	WRITE TAG	a2300/digitalOutput D03 invert:0
7	12/13/21 - 08:29:38	default	WRITE TAG	a2300/digitalOutput D04 invert:0
8	12/13/21 - 08:29:38	default	WRITE TAG	a2300/analogInput A12 MAX:1000
9	12/13/21 - 08:29:38	default	WRITE TAG	a2300/analogInput A12 MIN:0
10	12/13/21 - 08:29:38	default	WRITE TAG	a2300/analogInput A12 offset:400
11	12/13/21 - 08:29:38	default	WRITE TAG	a2300/digitalInput D11 function:0
12	12/13/21 - 08:29:38	default	WRITE TAG	a2300/digitalInput D14 function:12
13	12/13/21 - 08:29:38	default	WRITE TAG	a2300/digitalInput D12 function:24

Activity Log Screen

5.2 USER MANAGEMENT SETTINGS

The 2150+ allows you to edit and/or create your own users so that each person who interacts with the system can have their own personal login details.

Note: When the system is started for the very first time, and for every reboot thereafter, it boots up to “default” (user) which has admin rights (which can edit all settings).

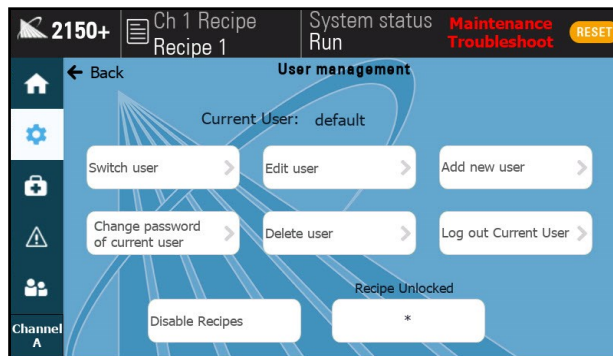

User management screen



ATTENTION: A system restart is required to apply any changes made to user settings.

Note: Should it ever be required contact your local Spray Specialist to receive instructions on how to perform a total system reset to factory settings.

Switch User

Sign out the current user by signing in a new user. This screen will also appear when selecting the users icon on the left menu bar.

User name: SSCO
Password:
 Show password
Back Sign In



Users button

Login or switch user screen

EDIT USER

Edit the selected user's properties. You can change the user's password for them, or change their User Group.

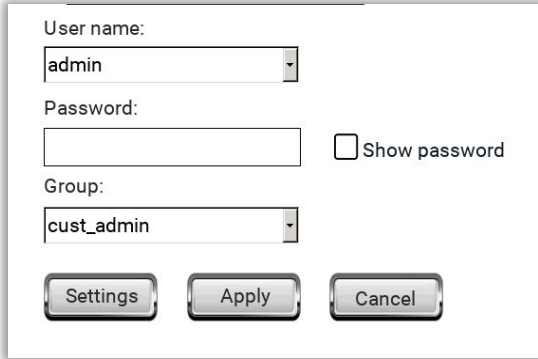

Edit user screen

ADD USER

Create a new user and assign them to a User Group. Ensure that you use the drop-down menu to pick the correct user group. Select "Add" to add the user to the 2150+ user list.

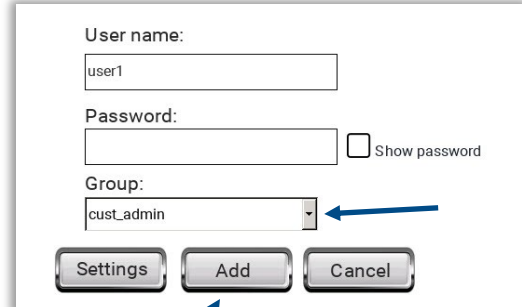

Add user screen

SETTINGS

The Settings option within Add new user gives you additional options.

You can:

- Require the new user to change their initial password on their first login
- Change how long the new user may remain logged in without any activity
- Setting the value to 0 will leave the user logged in until they choose to log out, or the system is rebooted.

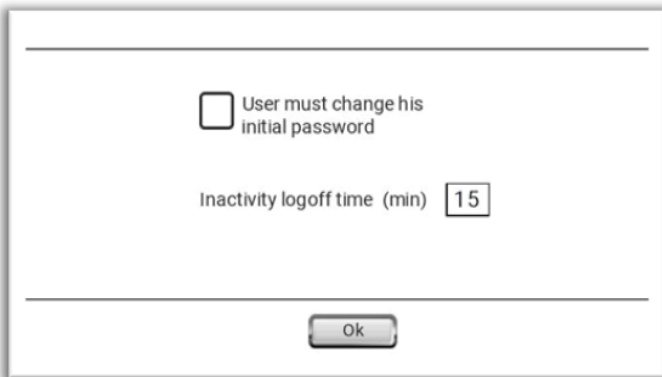

Add new user—settings

CHANGE PASSWORD

Allows you to change the password of the user that is currently logged in. Enter the user's current password then enter the desired new password. Select "Change" to confirm the action.



Change password screen

DELETE USER

This screen allows a created user to be deleted. You must select the username and group of the user you want to delete, then select "Delete" to remove the user.



Delete User Screen

LOG OUT

Yes or no choice to log out the current user. The 2150+ will return to the "default" user after someone logs out.

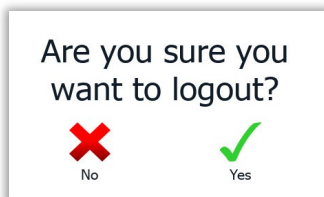

5.3 USER GROUPS

The system contains four preloaded users (username and password sets) that are the factory (default) settings. Users can choose to use (or edit) these existing users or create new users as they see fit.

Each of these default users has a different level of user rights to interact with the system based on their selected User Group. It is very important to pay close attention to the selected User Group for each current and created user. The table below shows the factory default users, user groups, and user rights. The minimum password length for all user groups is four (4) characters, and all user groups have access to basic spray control panel features.

Factory (Default) User Rights and Settings						
Default Username	Initial Password	User Group	Log Off Time (min)	Advanced Features	Edit/Add Users	Reboots to User
operator	oper	operators	n/a			
default	default	cust_admin	n/a	x	x	x
admin	admin	cust_admin	15	x	x	
SSCO	60189	admin	15	x	x	

USER GROUP:

Operators

These users can trigger the system and put it in standby mode. Operators can change the duty cycle setpoint. All other functions are disabled or read-only for users in the operator user group.

- The factory settings user “operator” is a member of this user group.

Cust_admin

These users have full control over all system settings and can edit or create new users.

- The factory settings user “admin” is a member of this user group.

Admin

There is a fourth factory settings user “SSCO” that is included with the system in User Group admin.

This user is included as a backup option to reset User Group cust_admin passwords if they are lost.

Do not use the “SSCO” user for daily operation of the unit. User Group admin and User Group cust_admin have the exact same access rights.



ATTENTION: A system restart is required to apply any changes made to user settings.

Default Username:

Initial startup and all reboots of the system will load into the factory settings “default” user profile.

Under factory settings, the user “default” is within the user group default, which has the exact same level of access as user group cust_admin.

- With factory settings, this user has full control over the system and can edit or create new users.
- Users can edit this user to change its access level.
- Can be changed to user group “operator” to remove edit access.
- Can set an Inactivity logoff time to require someone using the system to log in with their personal credentials after a set period of time.



SUPPLYING AIR TO THE SYSTEM

6.1 ADJUSTMENTS AND OPERATIONS

1. Turn the red valve on the air inlet valve/regulator/filter clockwise to the on position. Turn regulator that is on top of the air filter to an air pressure between 40-100 psi (2.8-6.9 bar). Air pressures higher than this will shorten the life of the pump.
2. Adjust the regulated air pressures (regulators on front panel).
 - If applicable, depending on the spray system you may have anywhere from Liquid Pressure regulation only to Liquid Pressure; Pump Air (preset); Atomizing Air (drop size); Fan Air (spray angle/pattern).
3. Each air control line is equipped with a manual air pressure regulator. The regulators can be adjusted by first pulling up on the knob to unlock the regulator and then turning clockwise to increase and counterclockwise to decrease the pressure.
4. When the desired air pressure is reached, press down on the knob to lock it in place.

Note: The system is equipped with cylinder air for air actuated spray nozzles. Cylinder air pressure is equal to the inlet air pressure to the system. It is not regulated; therefore, you must provide a minimum of 45 psi (3.1 bar) to the system. It must be above 45 psi (3.1 bar) to actuate air actuated nozzles like Spraying Systems Co.® 1/4JAU series.

5. Adjust the Liquid Pressure regulator. For pump version ensure that the pump inlet air valve is in the “open” position. The regulator can be adjusted by first pulling up on the knob and then turning clockwise to increase and counterclockwise to decrease the pressure. When the proper liquid pressure is reached, press down on the knob to lock it in place.

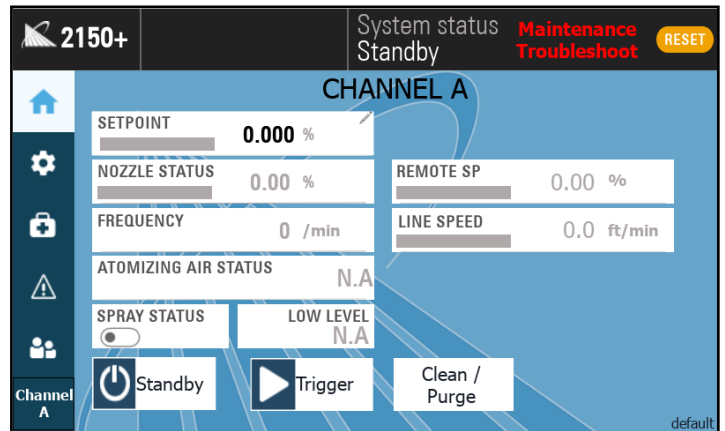

2150+ Home Screen

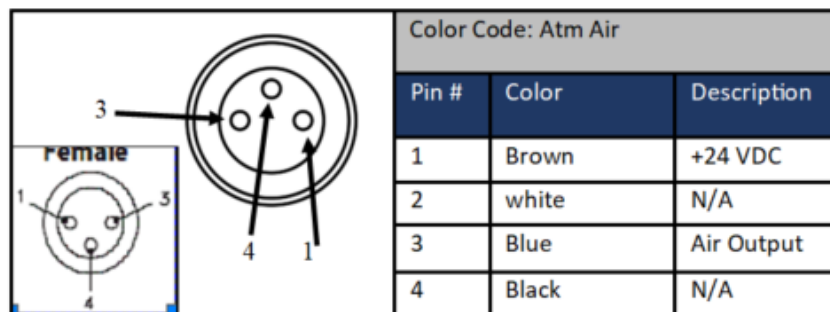

Air Connection Specifications

APPLICATION SETTINGS

Application settings allow you to customize the spray parameters to achieve the desired spray coverage and flow rates. These settings will also allow you to configure certain 2150+ accessories, such as the pressure sensor, flow meter, or line speed encoder.

Note: *Application Settings* and *Recipe Settings* configuration are the same. Use recipe function to configure most settings if the recipe feature is included in your system configuration.

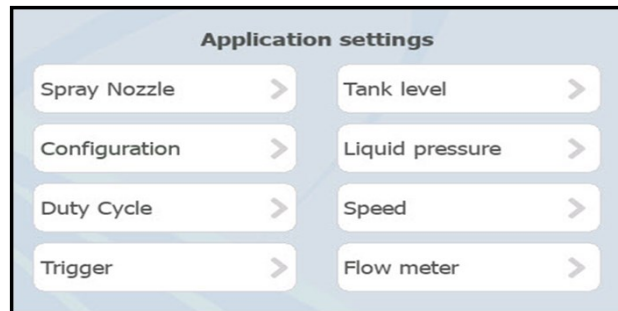

Application Settings

7.1 SPRAY NOZZLE SETTINGS

Note: See *Configuration* section or *Recipe Settings* for more information on timing settings. The Nozzle Settings screen allows for the editing of the Nozzle type and Cycle Speed.

Nozzle Type: nozzle family selection, atomizing air selection and anticipator/follower time.

Cycle Speed: allows for the editing of the minimum and maximum cycles per minute.

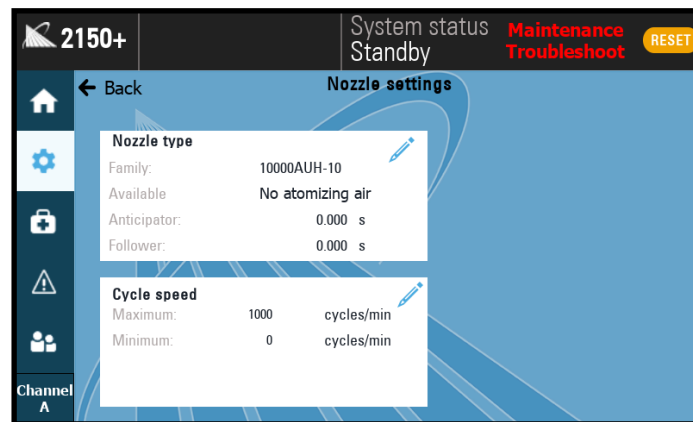

Nozzle settings screen

Selecting Nozzle Type:

- Nozzle Family: Select the type of nozzle supplied with the system.
—10000AUH-10 or -10JAU
- Enable Atomizing Air if required.
- Anticipator and Follower Time calculated in seconds.
- Advanced nozzle settings allows for editing the PWM Waveform settings.

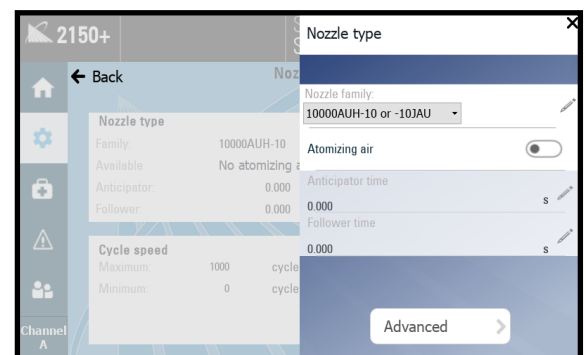

Editing nozzle type

ANTICIPATOR/FOLLOWER TIME

The system will start spraying when it receives a trigger signal and stop when the trigger signal is removed.

If the system is equipped with an air atomizing nozzle, the 2150+ will switch the air output on before it starts spraying to allow the spray pattern to develop fully. When the system stops spraying, the air will continue for a short period after to guarantee no large droplets can drip off of the nozzle. Max time for both is 10 seconds.

Note: The anticipator time must not be shorter than the start delay time set in the timing settings.

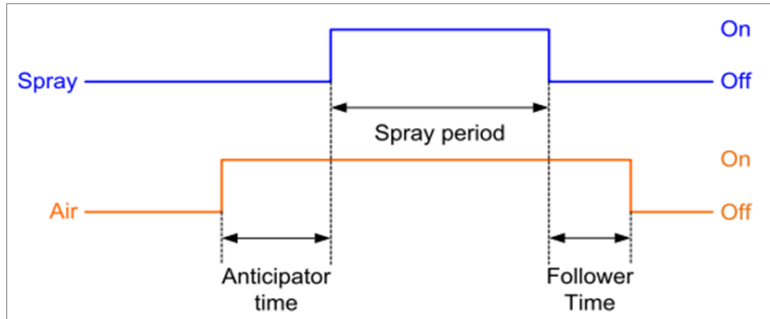

Anticipator-Follower

When a spray pattern is generated where the off time < (anticipator time + follower time), the air output remains on for the duration of this pattern.

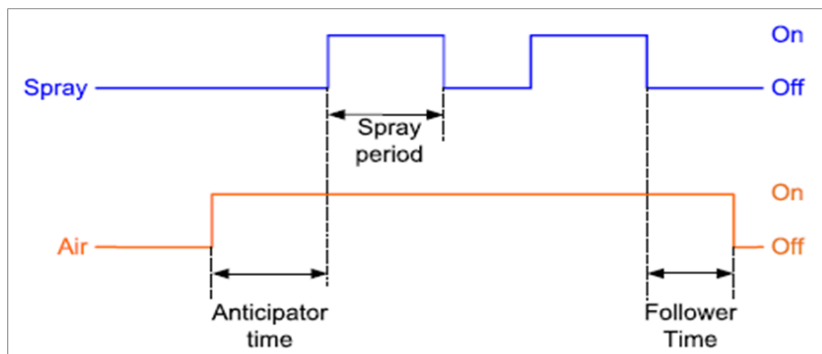

Overlapping anticipator / follower sequence

PARAMETERS—ADVANCED NOZZLE SETTINGS

For custom applications, it is possible to change the properties of the nozzle manually. These settings should only be modified by instruction from qualified SSCO personnel except for the nozzle cycle count.



WARNING: Incorrect settings can permanently damage the spray nozzle!

Negative Pulse: Pulse time in milliseconds

- Used to speed up the closing of the electric spray nozzle, duration is dependent on nozzle model and supply voltage.

V Hold: Holding voltage in V

- After the positive pulse, the signal drops to a hold voltage. This voltage is dependent on the type of nozzle and the liquid pressure. 24V is a safe value for this, but it can sometimes be lowered to minimize power consumption and heating of the spray nozzle.

Gun (Nozzle) Offset: Offset time in milliseconds

- The difference in the opening and closing time of the PulaJet nozzle can be corrected by using the offset value. The default value is 0ms. For example: If the offset value is set to -1ms, the on period will be decreased by 1ms and the off period will be increased by 1ms.

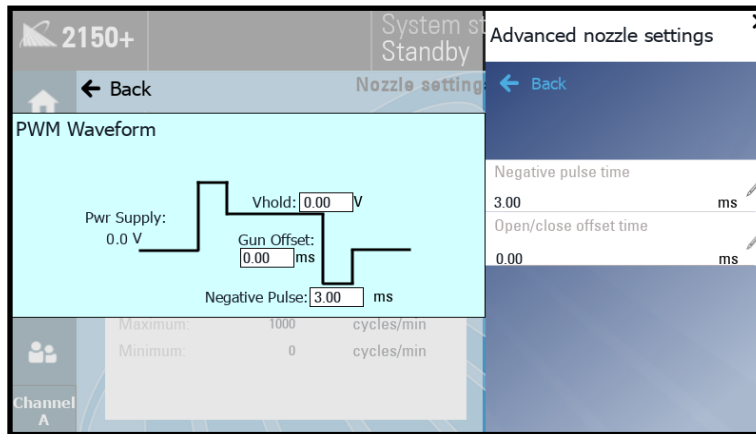

Editing advanced nozzle settings

If a nozzle wear cycle count alarm has been activated, the counter must be reset in this screen after the nozzle has been replaced.



CYCLE SPEED

The maximum frequency parameter (f_{max}) determines the maximum speed of the nozzle at 50% duty cycle and is entered as a number of cycles/minute. This parameter can be found in the datasheet of the electric spray nozzle being used. However, it is sometimes possible to use a higher value when a supply voltage of 48VDC is used.

The spray control panel will calculate the cycle speed to conform to the following requirements (in this order):

- As slow as possible to prevent wear of the spray nozzle.
- Correct duty cycle means $ON\text{-}time / (ON\text{-}time + OFF\text{-}time) = \text{duty cycle}$.
- OFF time lower than or equal to the maximum on/off time parameter. This prevents striping and very low frequencies at low duty cycles.
- ON time lower than or equal to the maximum on/off time parameter. This prevents striping and very low frequencies at high duty cycles.
- Frequency of the signal higher than the PWM minimum cycles/min setting. This can be used to keep the frequency constant for a large range of duty cycles.
- ON and OFF time higher than or equal to the minimum pulse width of the nozzle. This ensures that the nozzle is able to open and close at the same speed as the signal.

Cycle speed settings allows for the editing of the minimum and maximum cycles per minute, as well as the spray thickness which is the depth of the spray pattern. Maximum cycles speed is 15,000 cycles/min, minimum range is 0-60 cycles/min.

- **Maximum cycle speed:** Maximum speed that the nozzle should switch at for this application. This entry will be limited by the type of nozzle selected.
- **Minimum cycle speed:** Minimum cycle speed for the 2150+ is recommended for this application.

Note: If you want a constant cycle speed, enter a large spray thickness, and use the minimum cycle speed as your required cycle speed entry. The 2150+ will then cycle at this speed whenever possible.

Cycle Speed Example:

For a nozzle that can achieve 10,000 cycles/min, the minimum pulse width is 3ms. This ensures that the combination of duty cycle and cycle speed falls within the triangle curve of the PulaJet® electric spray nozzles (See figure below). The triangle is the approximate operating range of the nozzle. As long as operating parameters (duty cycle and frequency) are inside this triangle, the nozzle will operate normally. If the operating parameters are outside the triangle, the nozzle will not operate.

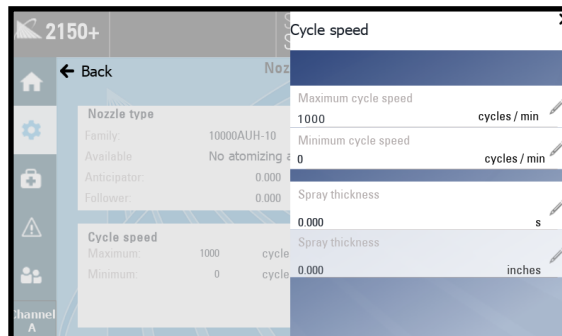

Editing cycle speed settings

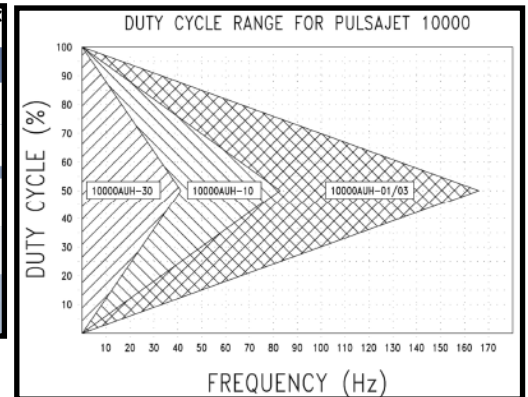

Example:

Spray Nozzle: AA10000AUH-03

- Maximum cycle speed: 10000 cycles/min
- Minimum cycle speed: 0 cycles/min (= disabled)
- Minimum pulse width: 3ms

Objective:

- Maximum on/off time: 0.010 s or 10ms
- Duty cycle: 30%

7.2 CONFIGURATION

Configuration settings allow you to set timing and setpoint spray parameters. Configuration will only appear when a system configuration **does not** include recipes. If the system configuration includes recipes, the button will display “Recipes” and will take you to the recipes screen.

Note: If you have recipes: see Recipe section for detailed information about Timing and Setpoint settings.

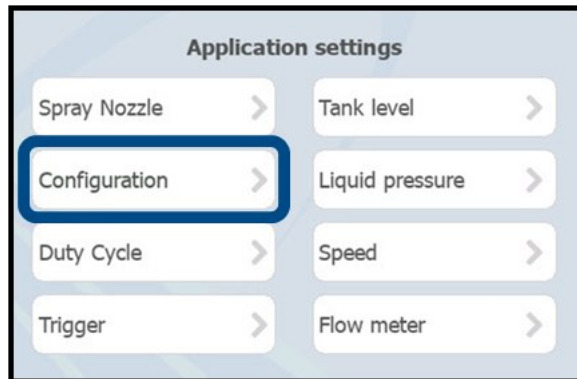

7.3 CONFIGURATION TIMING TAB SETTINGS

When editing the timing settings, make note of the available drop-down menu to ensure that you select the correct mode. Maximum Spray Period sets the max spray time, set the value to “0 s” to have the system follow the trigger signals. *Repeat* sets a repeat cycle, set the value to “0 s” for no repeat.

Note: See section Spray Timing Modes for more information.

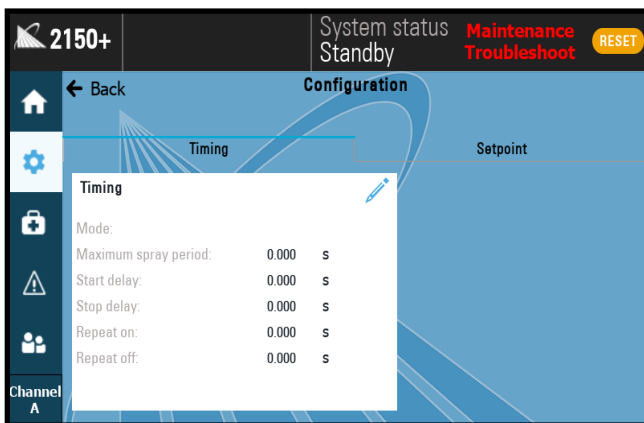

Timing settings

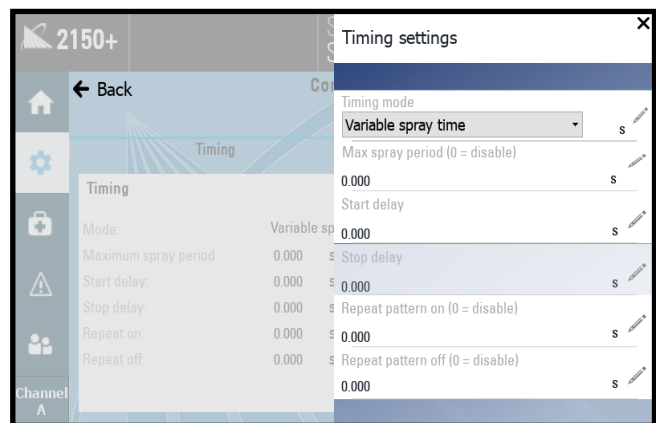

Editing timing settings

7.4 SPRAY TIMING MODES

Determine the spray mode required for the process.

There are four (4) timing modes you may utilize in the 2150+ Spray Control System.

- Fixed Spray Time
- Variable Spray Time
- Fixed Spray Distance
- Variable Spray Distance

Timing modes are selected by going to the HMI settings page and selecting the “Timing” button.

The system will spray for a predetermined time depending on the timing mode selected. The spray controller allows for accurate time-based control over the spray nozzle, based on an external trigger signal.

SETTINGS	DETAILS
Spray Period	<ul style="list-style-type: none"> • The spray period is the time the object remains under the spray nozzle or the time that it takes to dispense a dose. This will be in time units.
Start Delay	<ul style="list-style-type: none"> • The time that the system should wait between a trigger event and the start of the spray. • Typically, this is the distance between the sensor and the spray nozzle. • The start delay must always be longer than the configured minimum signal length of the trigger.
Stop Delay	<ul style="list-style-type: none"> • The time that the system should spray after a trigger event has finished. • Typically this is the distance between the sensor and the spray nozzle.
Repeat Off Period	<ul style="list-style-type: none"> • The Off Period is how long the system will not spray for. • This must be used in conjunction with the On Period setting to have an effect.
Repeat On Period	<ul style="list-style-type: none"> • The On Period is how the the system will spray for when repeat settings are used. • This must be used in conjunction with the Off Period setting to have an effect.
Spray Period	<ul style="list-style-type: none"> • The spray period is the duration of the spray after a trigger even is seen. <p>Note: This happens on the rising edge of the trigger event.</p>
Anticipator Time*	<ul style="list-style-type: none"> • This is used to send air to the nozzles prior to the spray starting. • This setting must be less than the Start delay. If this value is the same as or larger than the start delay. The air and spray will activate simultaneously.
Follower Time*	<ul style="list-style-type: none"> • This is used to continue sending air to the nozzles after a spray period has finished. • This setting must be longer than the stop delay to keep air flowing after a spray period has finished. <p>Note: Be careful that the Follower time does not carry over into the Anticipator time. This will result in the air staying open between spray periods.</p>

* For more information about anticipator/follower time see section 7.1 Spray Nozzle Settings.

7.5 FIXED SPRAY TIME

This timing mode is used to create a delayed spray pulse for a fixed predetermined amount of time.

Set parameter value to 0.

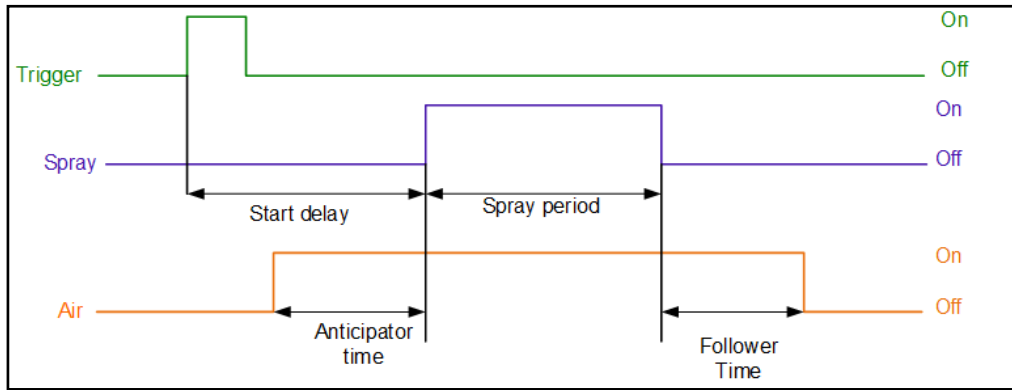

Fixed Spray Time

ANTICIPATOR PRIORITY

By default, the system gives priority to the start delay, potentially resulting in a too short or a zero-anticipator time, which may negatively impact the spray pattern if the start delay is too short. In this case, the start delay will be extended as required to provide a correct anticipator time. This is particularly useful when the start delay may not be known beforehand, for example when setting the timing using analog signals.

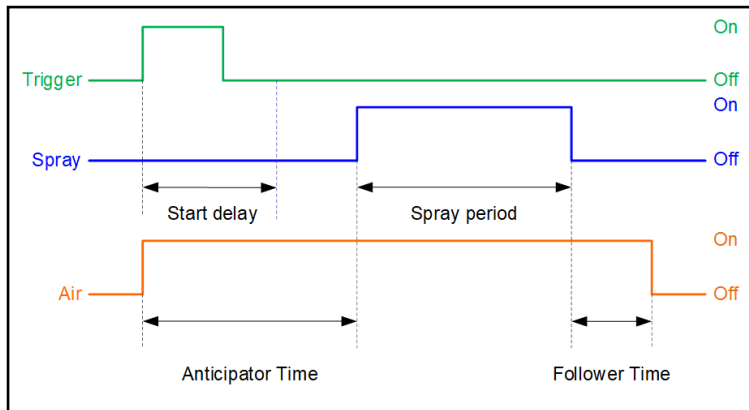

Anticipator Priority

Special Case: Multiple Triggers Without Spray Overlap

Occurs if the system receives multiple start events (rising edge of trigger signal) before a spray cycle is finished. If the time delay between two successive start events (or trigger pulses) is higher than the spray time, then there is no overlap.

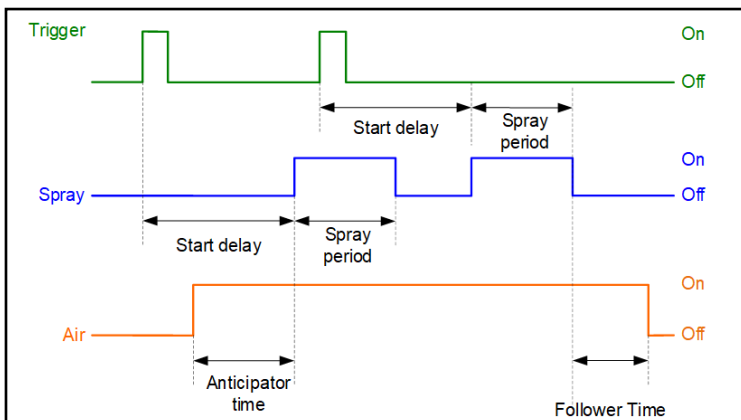

Multiple Triggers without Spray Overlap

Special Case: Multiple Triggers with Spray Overlap

Occurs if the system receives multiple start events (rising edge of trigger signal) before a spray cycle is finished. If the time delay between two successive start events (or trigger pulses) is lower than the spray time, then there is an overlap of two successive spray pulses.

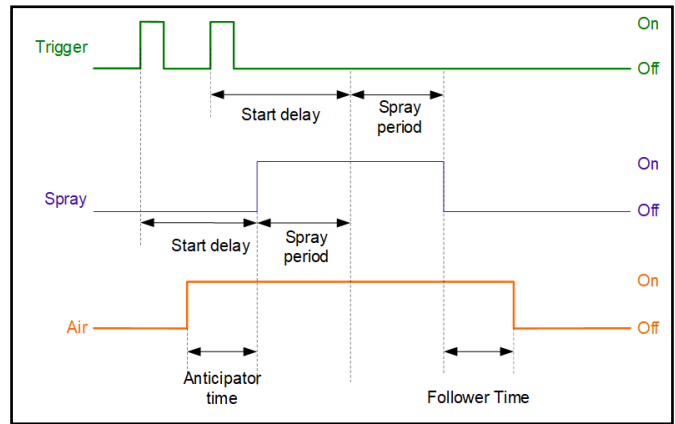

Multiple Triggers with Spray Overlap

FIXED SPRAY TIME—WITH REPEAT

This timing mode is used to create a continuous repetition of spray period for a fixed time.

Note: See Configuration settings or Recipe Settings for more information on Timing Mode setup.

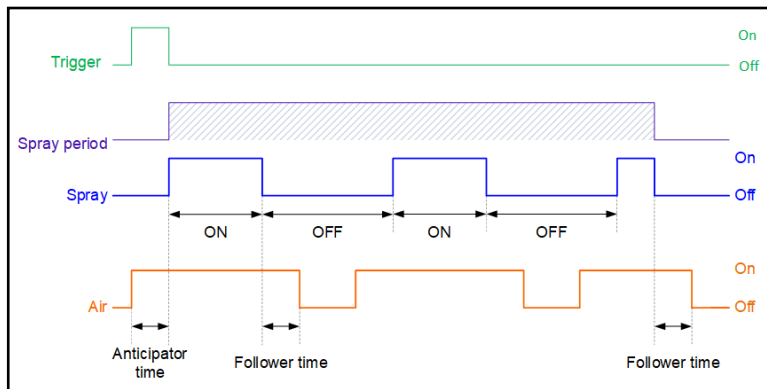

Fixed Spray

Special Case: Fixed Spray, Air Overlap: If repeat off-time \leq (anticipator + follower time), the air will remain on.

Note: This can happen in both fixed and Variable spray times.

- Sum of Anticipator and Follower Time is Higher Than Start Delay Time

If (anticipator time + follower time) $>$ off period, then the air will be kept on during the complete repeat cycle.

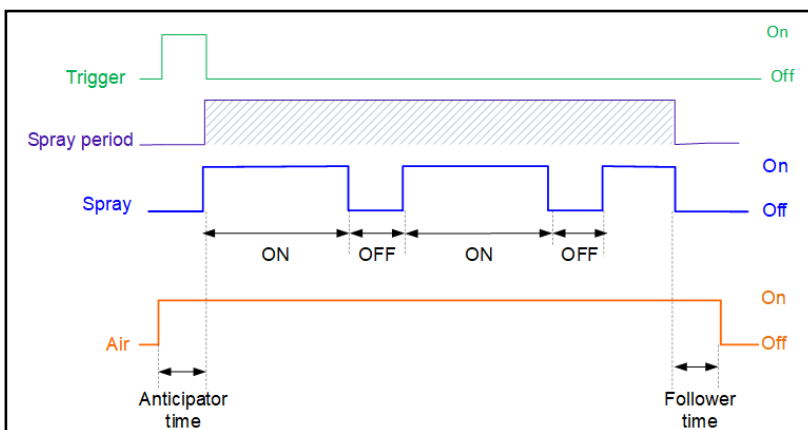

Repeat spray, air overlap

PARAMETER	VALUE
Start Delay	In seconds (s) or meters (m) - requires speed sensor
Off Period	In seconds (s) or meters (m), set value greater than 0
On Period	In seconds (s) or meters (m), set value greater than 0
Spray Period	In seconds (s) or meters (m), set value greater than 0
Anticipator Time	In seconds (s)
Follower Time	In seconds (s)

7.6 VARIABLE SPRAY TIME

This timing mode is used to create spray pulses with variable length. The lengths of the spray pulses depend on the specific time delays between the rising and falling edge of the trigger input.

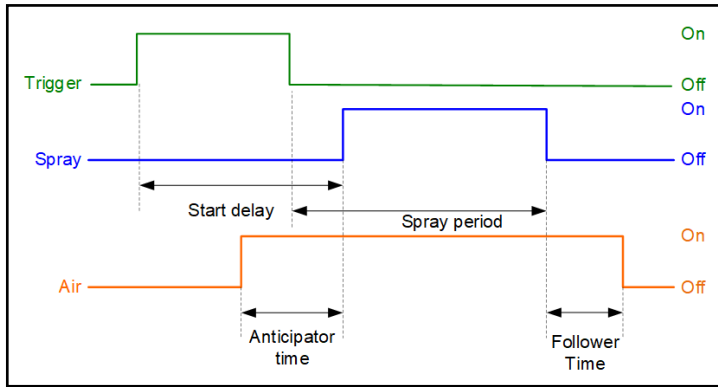

Variable Spray Time

PARAMETER	VALUE
Start Delay	In seconds (s) or meters (m) - requires speed sensor
Stop Delay	In seconds (s) or meters (m) - requires speed sensor
Off Period	Set value equal to 0
On Period	Set value equal to 0
Spray Period	Set value equal to 0
Anticipator Time	In seconds (s)
Follower Time	In seconds (s)

INCREASING AND DECREASING SPRAY LENGTH

The 2150+ will spray exactly as long as the object has been detected by the sensor when the Start/Stop Spray Delay are the same. This delay should then be equal to the time/distance delay between the position of the sensor and the position of the spray nozzle.

The spray distance (or time) will now always be exactly the same as the object length (or time).

INCREASED SPRAY LENGTH

- Decrease Start-delay: The spray is started before the object has reached the spray nozzle.
- Increase Stop-delay: The spray continues after the object has passed the spray nozzle.

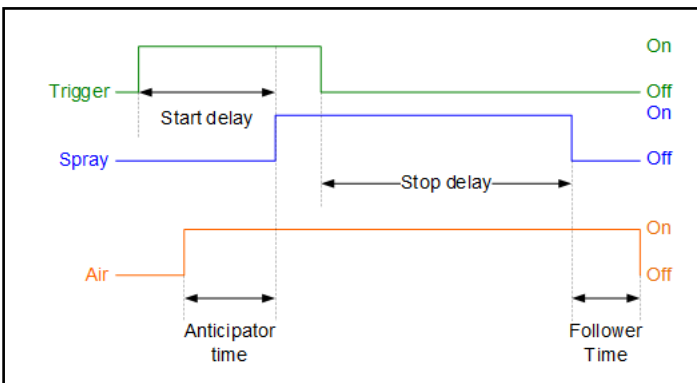

Variable spray time—increased spray period

DECREASING SPRAY LENGTH

The spray length can be decreased by:

- Increasing the Start Spray Delay: the spray is started after the object is already under the spray nozzle. In this case the beginning of the object is not sprayed
- Decreasing the Stop Spray Delay: the spray stops before the object has completely past the spray nozzle. In this case the end of the object is not sprayed.

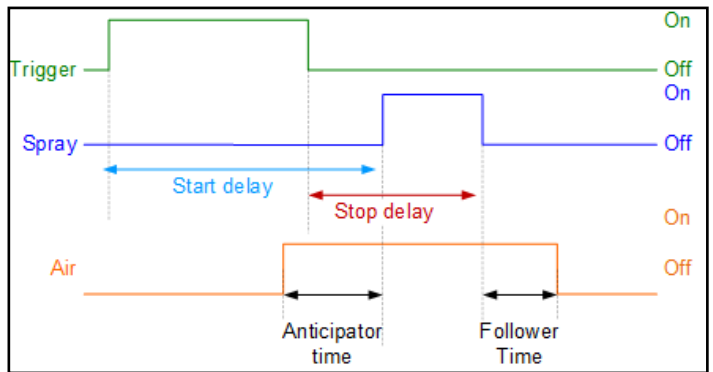

Variable spray length, decreased spray period

MULTIPLE TRIGGER EVENTS DURING SPRAY

If the system receives multiple start events before the spray cycle is finished, they will be added to a queue and executed according to the given delay times.

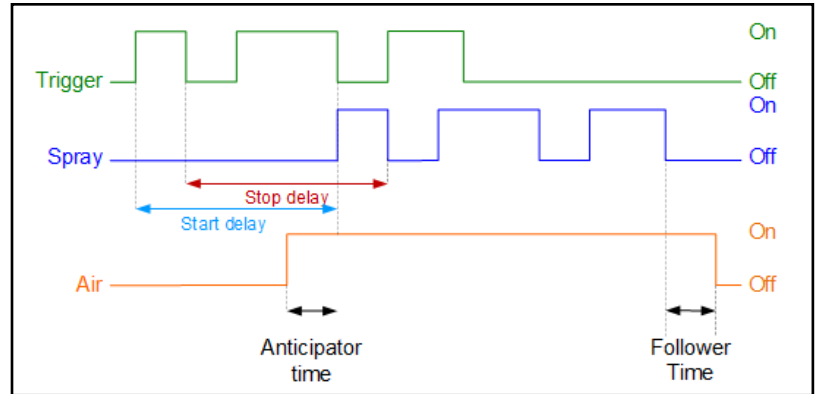

Variable spray period—multiple triggers

OVERLAPPING SPRAY EVENTS

If spray events overlap, the overlapping event will be ignored, and the system will continue to spray to ensure the objects are sprayed correctly. This situation may occur when the following is true:

- stop delay > start delay
- delay between two objects < (stop spray delay – start spray delay)

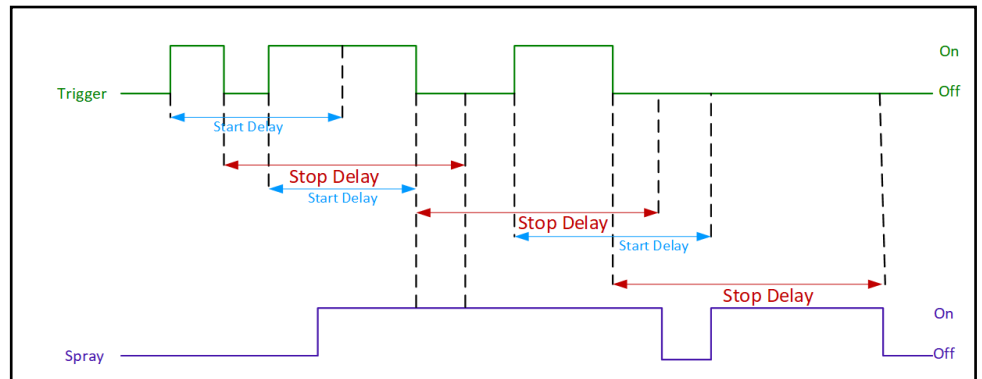

Variable Spray Events – Overlapping Triggers

OBJECTS TOO SMALL

If spray events overlap, the overlapping event will be ignored, and the system will skip the small object.

This situation may occur when the following is true:

- Stop spray delay < Start spray delay
- Object size < (start delay – stop delay)

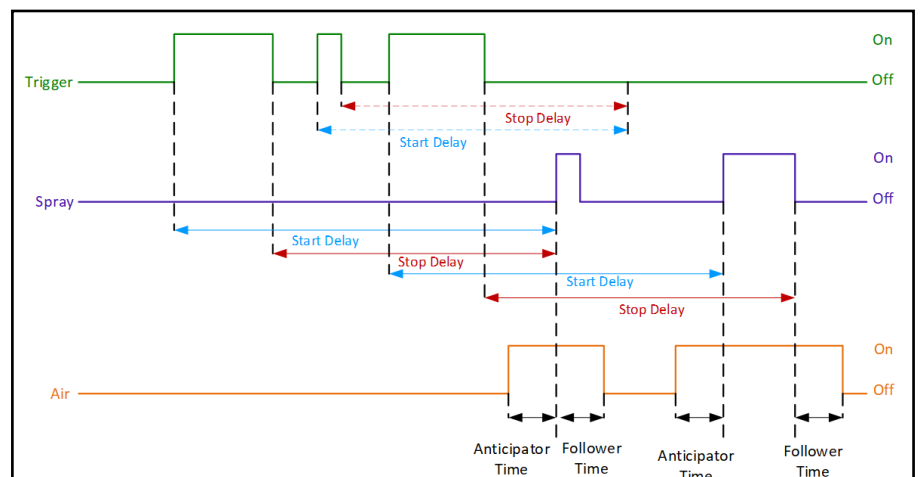

Variable Spray Period—Objects too small

DISTANCE DELAY, MAXIMUM SPRAY PERIOD

This timing mode is used to create a delayed spray pulse of an unknown period when receiving a trigger signal.

- The start and stop delays are typically the distance between the object sensor and the spray nozzle.
- The spray period is limited in time to the configured spray period.

In this timing mode, the repeat functionality works in time units.

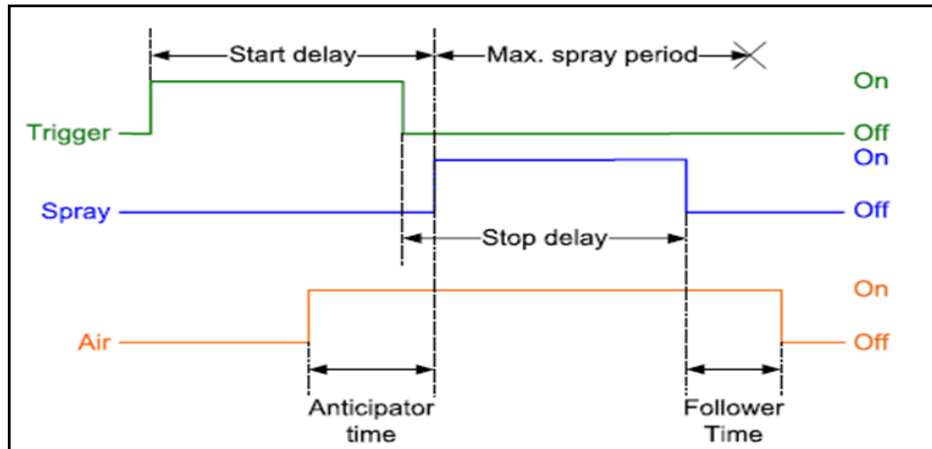

Distance delay, max. spray period

VARIABLE SPRAY LENGTH—WITH REPEAT

This timing mode is used to create a continuous repetition of spray pulses for a variable time. The duration of the repetition depends on the specific time delays between the rising and falling edge of the trigger input.

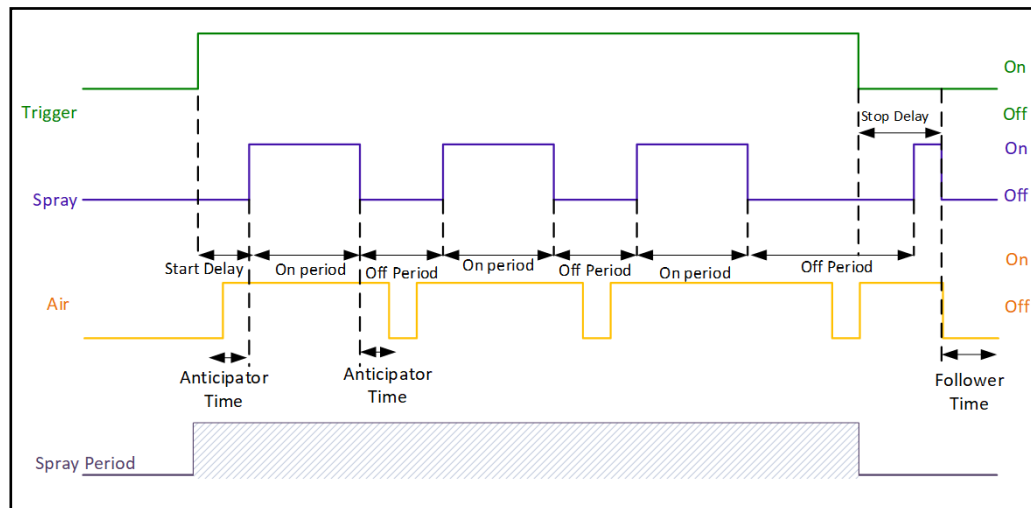

Variable spray length with repeat diagram

PARAMETER	VALUE
Start Delay	In seconds (s) or meters (m) - requires speed sensor
Stop Delay	In seconds (s) or meters (m) - requires speed sensor
Repeat Off Period	In seconds (s) or meters (m) - requires speed sensor, set value greater than 0
Repeat On Period	In seconds (s) or meters (m) - requires speed sensor, set value greater than 0
Spray Period	Set value equal to 0
Anticipator Time	In seconds (s)
Follower Time	In seconds (s)

7.7 FIXED AND VARIABLE SPRAY DISTANCE

DISTANCE BASED SPRAY TIMING

The fixed and variable timing modes uses distances instead of time. In these modes, delays are expressed in distance units. These are the units that were chosen when calibrating the frequency input.

The anticipator time in these modes has a special behavior, it is converted to a distance using the maximum speed, meaning that it is a minimum anticipator time. At speeds below the maximum speed, it will be longer.

PARAMETER	VALUE
Start Delay	Meters (m) - requires speed sensor
Stop Delay	Meters (m) - requires speed sensor
Repeat Off Period	Meters (m) - requires speed sensor, set value greater than 0
Repeat On Period	Meters (m) - requires speed sensor, set value greater than 0
Spray Period	Set value equal to 0
Anticipator Time	In seconds (s)
Follower Time	In seconds (s)

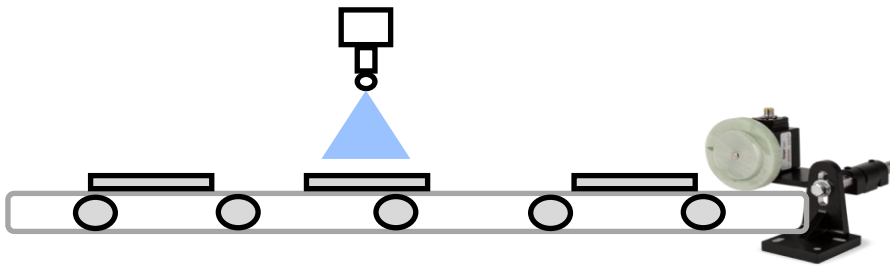

7.8 CONFIGURATION SETPOINT TAB SETTINGS

The Setpoint tab sets all of the fluid-related parameters. Use the drop down menu to select the Setpoint Regulation Mode of either application-rate, duty cycle, or flow.

- Setpoint (gal/ft²) - The target value for the system to spray at.
- 100% flow reference (GPM) - The expected flow rate for the system. This will be used when using Flow mode.
- Reference Spray Pressure (PSI) - The expected pressure the system will be running at. This will be used with the Pressure mode in Pressure settings.
- Spray Width (ft) - The width of the spray pattern. This will be used to calculate the volume of liquid when using Application Rate mode.

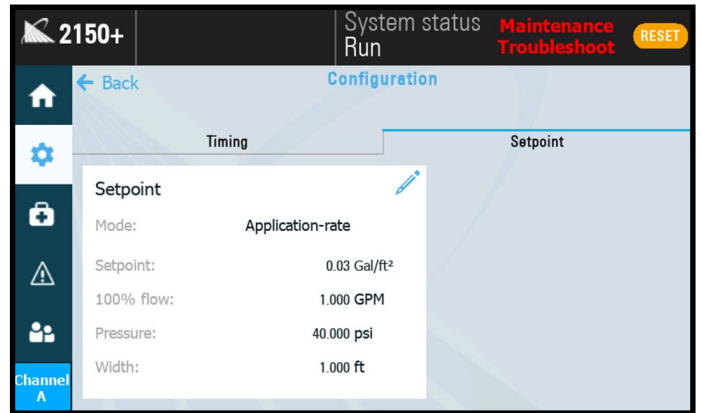

Setpoint settings

SETPOINT - DUTY CYCLE

Operates by allowing the user to set the desired percentage control for the cycle rate. Set the other values as desired to establish the duty cycle. Fluctuations in the spray pressure can be monitored by the connected pressure sensor and real-time adjustments to the setpoint will be made.

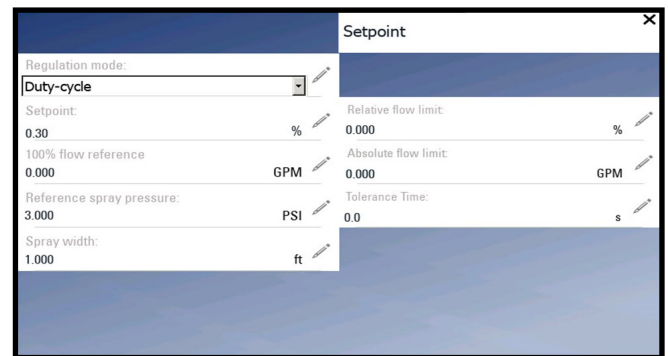

Duty-cycle settings

SETPOINT - APPLICATION RATE

Application rate is based on the area that is going to be sprayed. The 2150+ will calculate a certain percentage of the max cycle rate to obtain the required coverage rate and area.

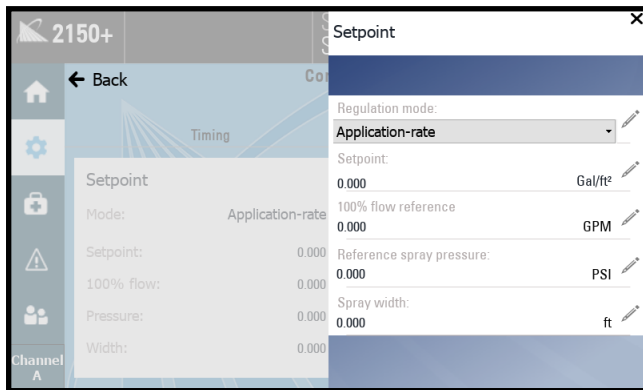

Application-rate settings

Application Rate requires the use of an encoder. Setpoint is an area measured in Gal/ft². This is calculated based on the spray width setting and how fast the conveyor is moving multiplied by the flow rate (GPM(FPM*FEET)).

$$\text{Duty cycle of the spray gun} = \left(\text{Duty cycle setpoint}(\%) \times \frac{\text{Speed value} \left(\frac{\text{distance unit}}{\text{s}} \right) \times \text{spray width} (\text{distance unit}) \times \text{Application rate} \left(\frac{\text{mass unit}}{\text{distance unit}^2} \right)}{\text{Density} \left(\frac{\text{mass unit}}{\text{volume unit}} \right) \times \text{Maximum flow} (\text{volume unit/s})} \right) + \text{Duty cycle offset}(\%)$$

SETPOINT - FLOW

Flow mode uses the nozzle's expected flow rate. A user sets the spray parameters by entering the desired values for setpoint and 100% flow reference.

For example if 0.5 GPM (100% Flow Reference Setting) is inputted and the setpoint to spray is at 0.25 GPM it will use a 50% duty cycle to obtain that value (or half the cycle rate).



ATTENTION: This mode **DOES NOT** receive input from a connected flow meter.

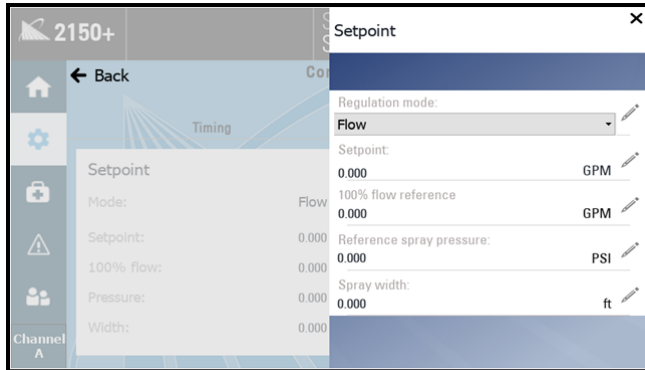

Flow Configuration Settings

7.9 RECIPE SETTINGS

Recipes can be accessed quickly from any screen by selecting the recipe section of the top bar, as shown in the image below.

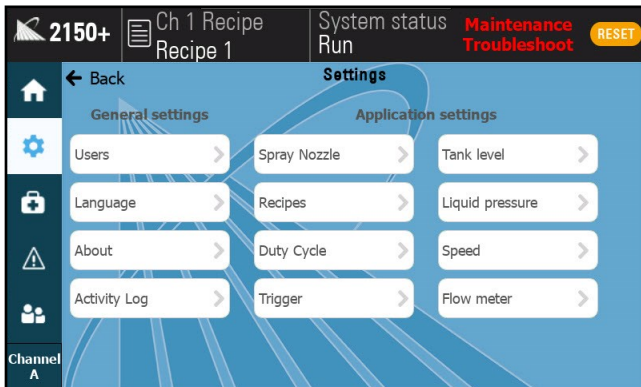

Recipe Settings screen

The recipe settings sections contains four tabs. The drop down list near the top of the page allows you to select which recipe you would like to view, edit, or apply as the current spray parameters. The 2150+ is capable of storing up to 20 user-created recipes.



Select the recipe from any screen

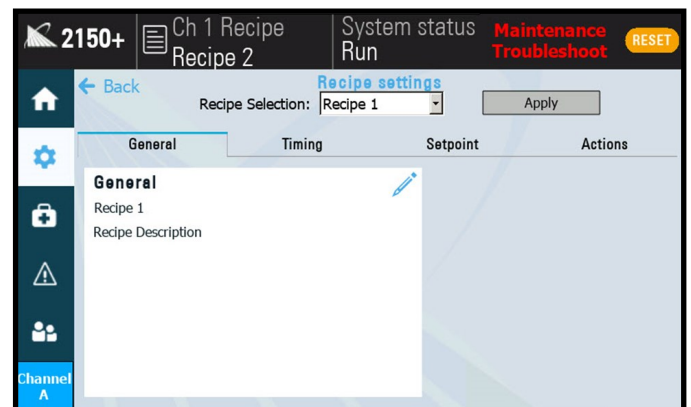

Settings screen with recipes enabled

GENERAL TAB

You can change the name of the recipe and create a recipe description using the blue pencil icon. This can allow operators to easily differentiate between recipes when changing spray parameters is required.

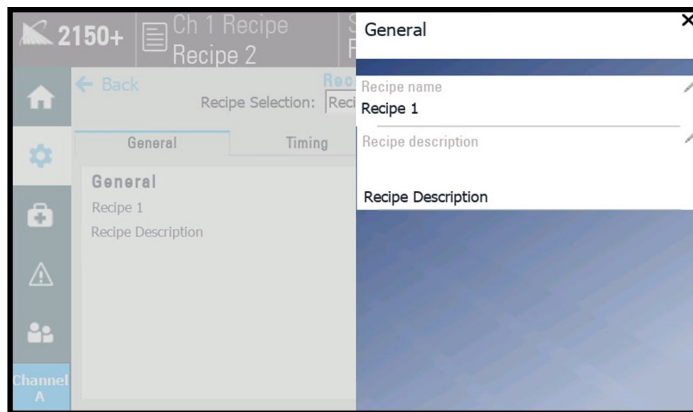

Recipe settings, General tab

TIMING TAB

The Timing tab sets all of the timing-related parameters for your recipe. Use the drop down menu to select the timing mode, then set all of the timing values.

See section *2150+ Spray Timing Modes* for more information.

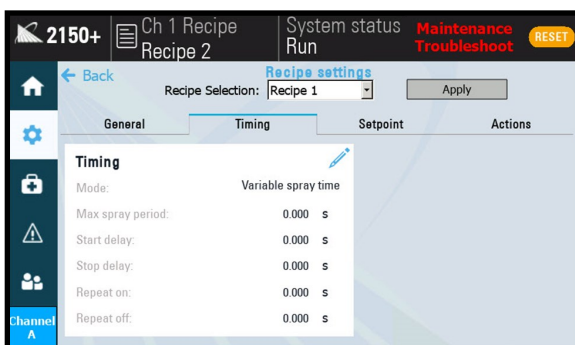

Recipe settings. Timing tab

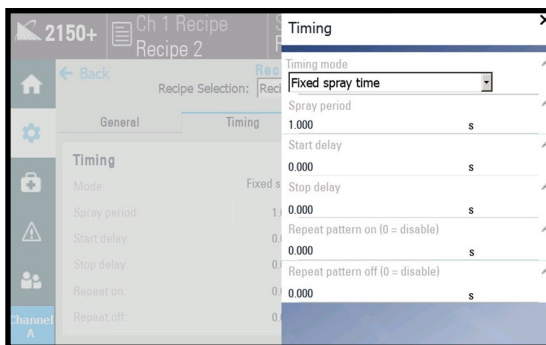

Editing values in the Timing tab

SETPOINT TAB

The Setpoint tab sets all of the fluid-related parameters for the recipe.

—100% Flow: The value of 100% flow represents the maximum flow rate acceptable for the spray application. Enter the pressure in psi of the spray application, as well as the spray width of the current application.

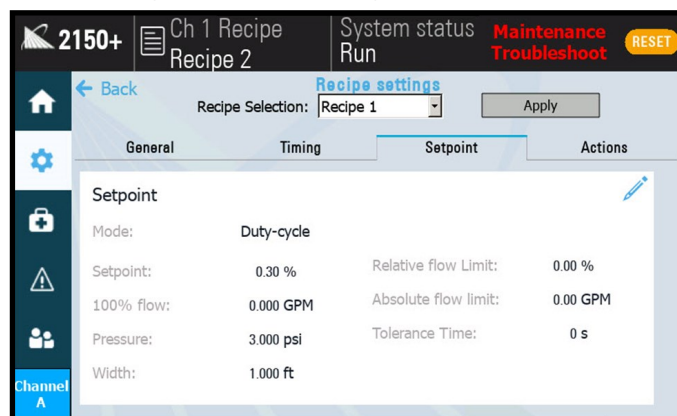

Recipe settings, Setpoint tab

ACTIONS TAB

The actions tab allows you to load all current system recipes onto a USB stick for easy transfer to another spray control panel, or to load in previously created recipes stored on a USB stick to a spray control panel.

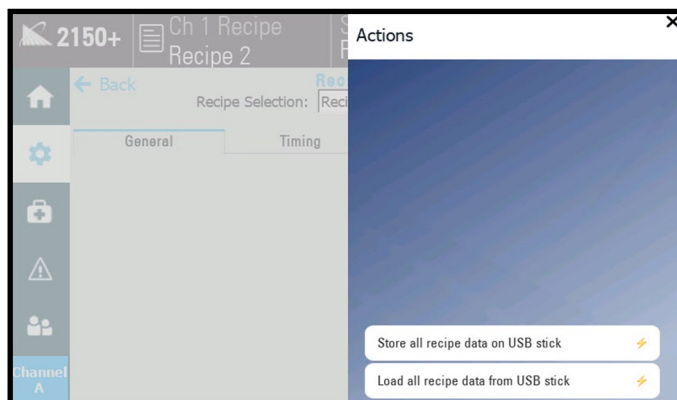

Recipe settings, Actions tab

7.10 DUTY CYCLE

Duty cycle represents the ratio of the spraying "on" time to the "off" time, which results in some percentage of the maximum possible (continuous) flow through the nozzle. The duty cycle settings allow you to select the source and enter sensor default values. Selecting 4-20mA signal will allow you to configure the sensor. The other option is remote setpoint, which requires a cable to connect to an external PLC. When connected correctly, the Duty Cycle on the controller display adjusts according to the input signal, 4mA corresponds to 0% duty cycle and 20 mA corresponds to 100% on.

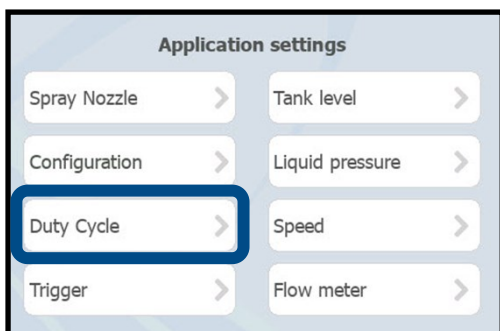

DUTY CYCLE SETTINGS

Select whether the duty cycle source will be local or 4-20mA signal.

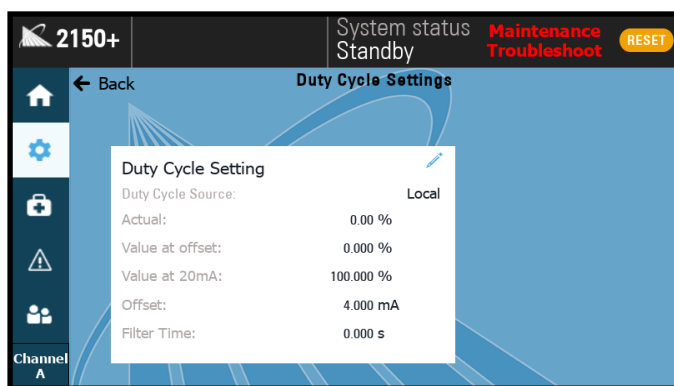

Duty cycle settings

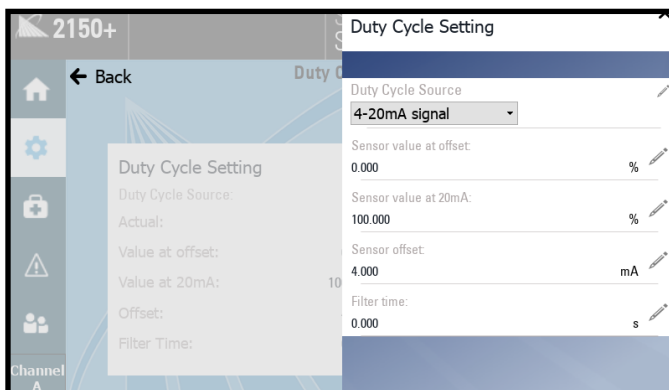

Editing duty cycle settings

- **Sensor Value at offset:** The minimum value of percent that offset the starting point to control Duty Cycle.
- **Sensor Value at 20mA:** The maximum value of setpoint for the remote duty cycle to control. Set the value at 20mA to be 100% or another value depending on the trigger source.
- **Sensor Offset:** The minimum level of the sensor offset can control usually starting from 0mA or 4mA. Set the sensor Offset to match the baseline mA value of the sensor (lowest value).
- **Filter time:** Used to control interference/noisy signals from sensor.

ASSEMBLY SPECIFICATIONS:

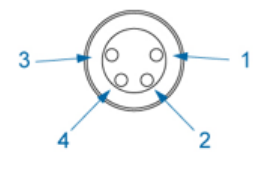
	Color Code: Duty Cycle		
	Pin#	Color	Description
	1	Brown	+24 VDC
	2	White	DO2
	3	Blue	0 VDC
4	Black	4-20mA	

If the 0 VDC is coming from a power supply outside of the panel (PLC), connect it to this wire—#3

- Panel connection: 4-20mA
- Part number: LE00M8M5M
- Cable: 16.4 ft. [5 m] cord
- Flying Leads
- Connector – M8 4 pin male

—DO2 represents the spray status in the form of an On/Off signal depending on whether the 2150+ is actively spraying. This can be used to monitor the active status externally.

REMOTE SETPOINT (AI2) [0-20MA] DUTY CYCLE

The duty cycle setpoint is multiplied by the value of the input to calculate the actual duty cycle. The following equation represents the calculation made by the 2150+.

$$\text{Duty cycle of the spray gun} = (\text{Duty cycle setpoint}(\%) \times \text{measured value}(\%)) + \text{Duty cycle offset}(\%)$$

7.11 TRIGGER

If you have an external trigger source, select the correct and corresponding option for the external trigger from the drop down list. Toggling the "Inverted" option to the On position will allow the use of a trigger that sends a signal when off rather than when on. Tracks up to 50 objects.

Pin #	Color Code: Trigger	
	Color	Description
1	Brown	+24 VDC (only used for sensors)
2	white	Not Conncted
3	Blue	0VDC
4	Black	DI2



Note: Do not supply pins 2 or 5 with the 24V model.

TRIGGER SETTINGS

- **Minimum length:** Filters out a trigger signal that is less than the specified time. This setting can only be used while there is a start delay.
- **Max. event frequency:** When the max trigger frequency is exceeded, the signal is treated as noise and will not give the controller a trigger signal. A higher max frequency allows for more noise and could cause unnecessary triggers from a bad signal. Signals that have some noise, but should still be considered triggers should be accounted for with this setting.
- **Trigger Source:**
 - Local - Will place a trigger button on the home screen that must be pressed every time the system needs to be triggered.
 - DI2 - Trigger is activated via the "Trigger Connection"
 - DI2+DI4 - DI4 is the trigger interlock connection. This will place the system into standby mode when DI4 is low. DI2 operates as normal when in run mode.
- **Check Trigger On Run:** When this option is activated, if the system goes from standby to run mode the system will look for a trigger signal and spray when the trigger is high. If this setting is off the system will look for a fresh trigger signal to resume spraying.

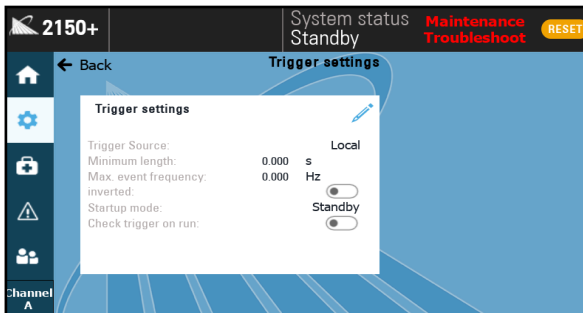

Trigger settings

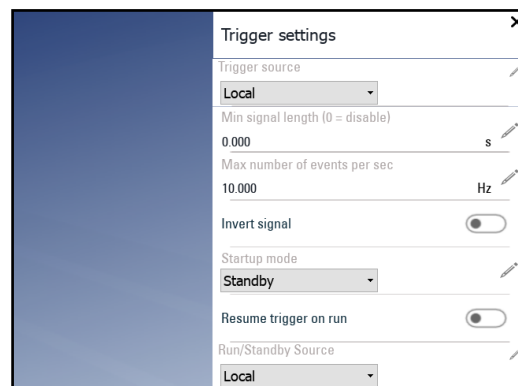

Editing the Trigger Settings

- **Trigger Interlock:** Controls the state of run/standby. When the signal is low it will put the system in standby mode and spraying will stop. When the signal is high again it will be put back into run mode.

Pin #	Color Code: Trigger Interlock	
	Color	Description
1	Brown	+24 VDC
2	white	DI4
3	Blue	0VDC
4	Black	Not Connected

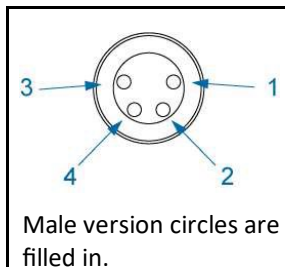

7.12 TANK LEVEL SENSOR

If your configuration includes a pressure pot with a level switch, select the edit button and use the drop down menu to activate the level sensor signal. Once turned on the 2150+ can now see the low level condition.

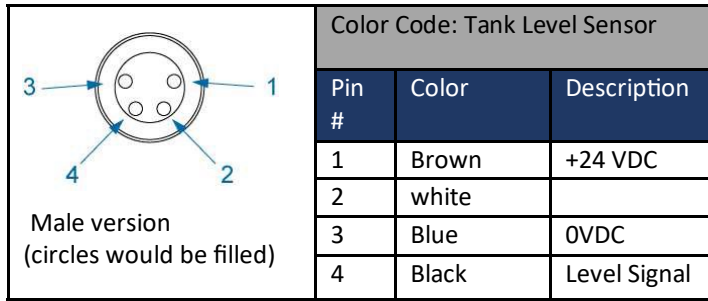

Plug and Spray connections, level sensor

TANK LEVEL SENSOR SETTINGS

- **Tank Level Sensor**—Sends the alarm signal based on its current configuration values.
- **Input status**—Shows low level regardless if input is turned on.
- **Low Level Status**—If Input status is turned on and level is low, this will toggle on.
- **Invert signal**—If you have a normally open level switch (open until liquid level goes low), do not turn this on. If you are using a normally closed float, toggle this on.
- **Standby on fault**—If you want the spray to stop when level is low, toggle this on.



ATTENTION: When the tank level is low, the 2150+ will show a fault on the screen (tank low), but it will not stop the nozzle from spraying. Toggle on “Go to standby on fault” if you want the 2150+ to stop spraying when the tank level gets low. The level sensor will send the alarm signal based on its current configuration values.

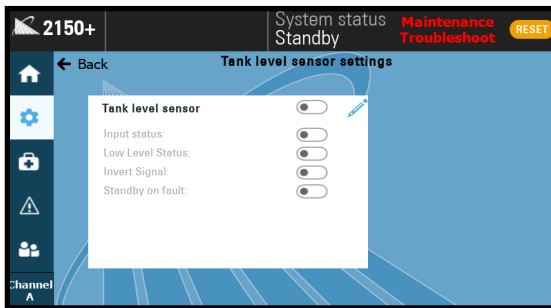

Tank level sensor settings

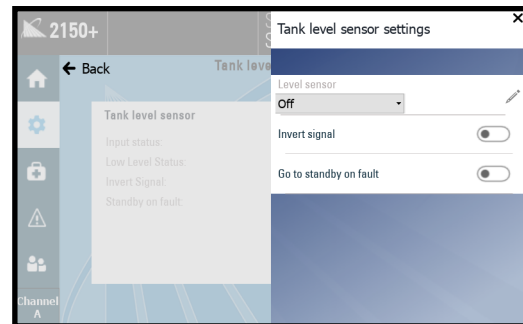

Editing the tank level settings

SEVEN-GALLON TANK AND LEVEL KIT SPARE

SEVEN-GALLON TANK AND LEVEL KIT	
PART	PART NUMBER
Seven-gallon polyethylene supply tank with open top lid	070TS07000037W0_BA01
Clamp, Hose, SAE 12, 11/16" - 1-1/4" ID range, 1/2" band, 301 SS band x zinc plated steel screw	CLXS8HCI0U1H00
Braid reinforced Tygon tubing, 3/4" IDT x 1-1/16" OD, 135psi @ 73-deg F	FT005624K55
7 Gallon Natural Plating Tank with Cover - 10" Dia. x 20" High, LLDPE	TK004029_AC01
Polypropylene check valve, 3/4" (f) NPT	VC005492K54
Liquid level switch, food contact rated, with M8 (f) electrical cable	070TS07000038W0



PRESSURE SENSOR (OPTION)

8.1 LIQUID PRESSURE (PRESSURE SENSOR)

Liquid Pressure settings require an active pressure sensor connection to the 2150+. When connected, the input settings are to be calibrated to match the specifications of the pressure sensor.

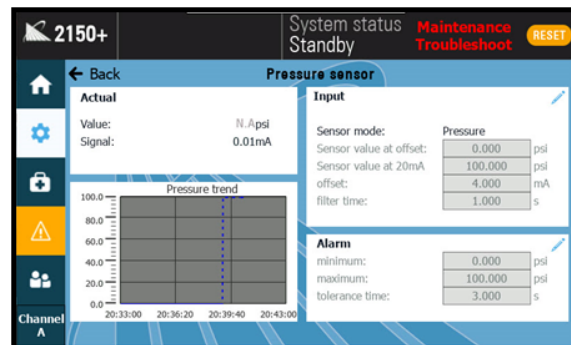
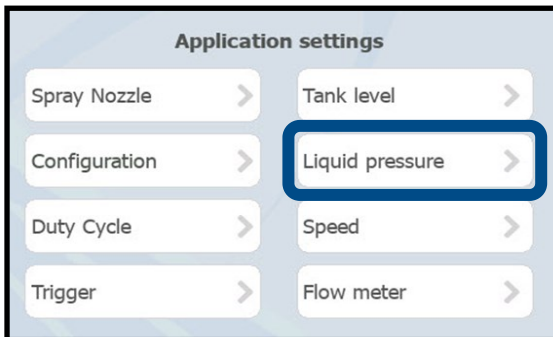

Pressure sensor settings screen

Actual: displays the current live readings from the pressure sensor.

Pressure trend graph: provides a visual representation of the current live readings.

Input settings: allows you to align the system with the specifications of the pressure sensor.

Alarm settings: allows you to set a minimum and maximum psi value for minimum and maximum spray pressure, so that if the reading falls outside of these values for the tolerance time a fault will occur.

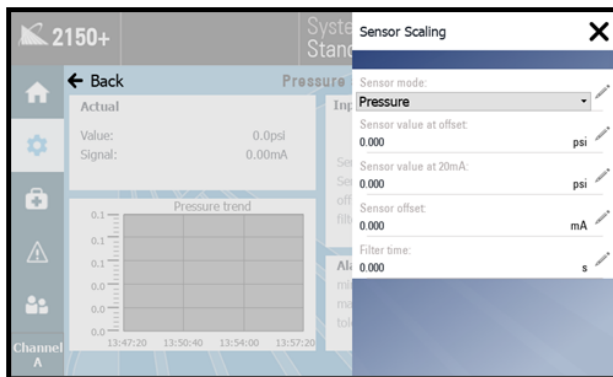

Editing the input settings

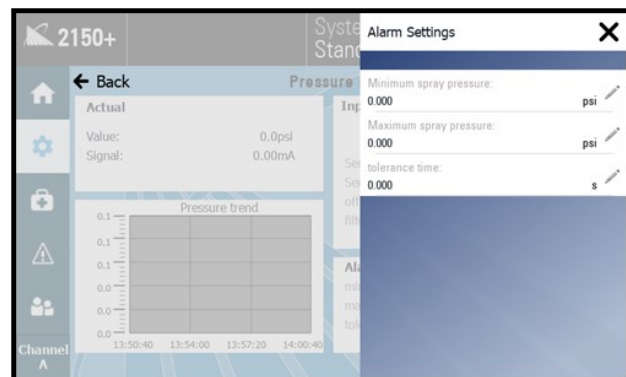

Editing the alarm settings

- **Tolerance Time:** The time an alarm condition is met before activating the alarm.
- **Sensor Mode:** Pressure, Pressure– alarm only, and off settings.
Note: The mode “Pressure - alarm only” will not adjust any of the spray parameters based on the pressure sensor readings and will only trigger an alarm if the pressure falls outside of the set ranges.
- **Sensor Value at Offset:** The minimum value of psi that offsets the starting point that controls pressure sensor.
- **Sensor Value at 20mA:** The maximum value of psi that the pressure sensor can control.
- **Sensor offset:** The minimum level of the sensor offset that can be controlled usually starting from 0mA or 4mA.

CALCULATING DUTY CYCLE—PRESSURE SENSOR

When using the pressure sensor, the duty cycle setpoint is multiplied with the square root of the expected pressure value and divided by the pressure input to calculate the actual duty cycle.

$$\text{Duty cycle of the spray gun} = \left(\text{Duty cycle setpoint} (\%) \times \sqrt{\frac{\text{Expected pressure}}{\text{Measured pressure}}} \right) + \text{Duty cycle offset} (\%)$$

STANDARD PRESSURE SENSOR

Do **not** use the standard pressure sensor with fluids containing solids.

- Measuring range: 0-100 psi
- Connection type: 1/2" NPT (male x female)
- Protection rating: IP67/IP69K
- Cable details: M12 (M) - 5m



FLUSH-STYLE PRESSURE SENSOR

Use the flush-style pressure sensor with fluids containing solids.

- Measuring range: 0-145 psi (0-10.0 bar)
- Connection type: 1/2" NPT (male x female)
- Protection rating: IP67/IP69K
- Cable details: M12 (M) - 5m



ASSEMBLY SPECIFICATIONS

Color Code: Pressure			
Pin #	Color	Description	
1	Brown	+24 VDC	
2	white	4-20mA Signal	
3	Blue	0V	
4	Black	N/A	

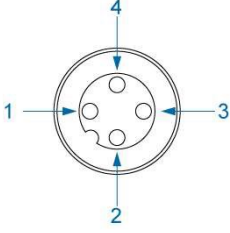

Plug and Spray connections, pressure sensor (located on bottom of 2150+)

8.2 PRESSURE SENSOR SPARE PARTS

PRESSURE SENSOR	
PART	PART NUMBER
Five-meter cable, M12 (f), M12(m)	LEXXSD4FD4M005P
Pressure transmitter, 2- or 3-wire DC, 4-20mA output, 1/4" NPT process connection, -14.5...145 psi range, 4-pin M12, IP69k protection rating, stainless steel.	PR00PT2415
Pressure Sensor Kit (cable and pressure transmitter), standard, all types (no solids), threaded	060TS06210008A0

PRESSURE SENSOR (FLUSH)	
PART	PART NUMBER
Five-meter cable, M12 (f), M12(m)	LEXXSD4FD4M005P
Pressure transmitter, 2- or 3-wire DC, 4-20mA output, G1 BSPP process connection, -14.5...145 psi range, 4-pin M12, IP69k protection rating, stainless steel.	PR00PM1604100
Flush Mount Pressure sensor adapter, G1 BSPP to 1/4" NPT process connection, 316 stainless steel and EPDM.	PR00U30026
Flush style Pressure Sensor kit (cable, pressure transmitter, and adapter), fluids containing solids, threaded	060TS06210009W0

SPEED/ENCODER(OPTION)

9.1 SPEED/ENCODER KIT

The encoder kit can be used with the Application Rate Setpoint to control the system with units of distance instead of timing. Speed/Encoder settings require a connected line speed encoder.

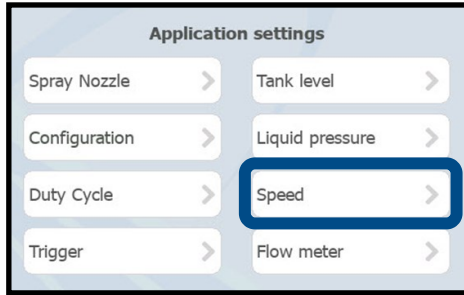

Plug and Spray connections, encoder (located on bottom of 2150+)

SPEED SETTINGS

- **Speed Settings Sources:** Simulated, Digital Signal, and Ethernet IP
- **K Factor:** K-Factor is a calibration constant used to correlate the encoders pulses per feet to the controllers calculations (K factors range from 1024, 2048, or 512,etc..).
- **Zero frequency threshold:** The minimum level of pulses for the speed to be considered zero.
- **Filter Time:** Used to control interference/noisy signals from sensor.

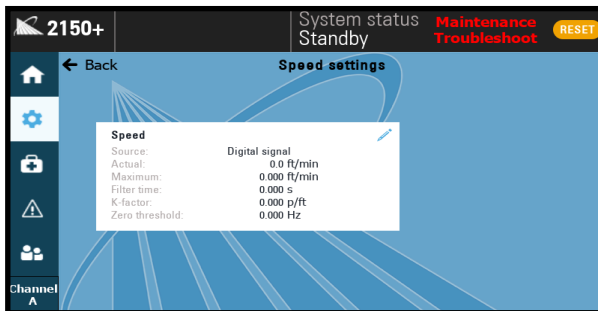

Line speed settings screen

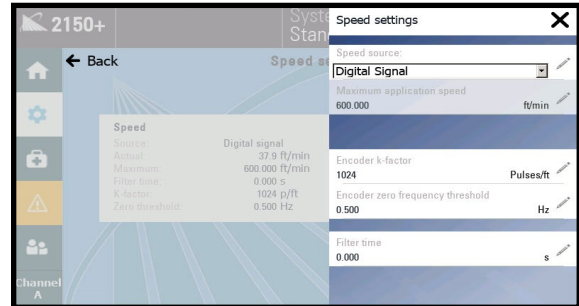

Editing line speed settings

ASSEMBLY SPECIFICATIONS

Color Code: Encoder			
Pin #	Color	Description	
1	Brown	+24 VDC	
2	white	N/A	
3	Blue	0V	
4	Black	Digital Speed Signal	

CALCULATING DUTY CYCLE—ENCODER

When using the encoder, the duty cycle setpoint is multiplied by the value of the speed input and divided by the maximum speed value to calculate the actual duty cycle.

$$\text{Duty cycle of the spray gun} = \left(\text{Duty cycle setpoint}(\%) \times \frac{\text{Current Speed}}{\text{Maximum speed}} \right) + \text{Duty cycle offset}(\%)$$

9.2 ENCODER SELECTION

With the 2150+, you can select either the hollow shaft or wheel and pivot mounted style encoder. The hollow shaft style will mount into the conveyor, while the wheel and pivot style requires the wheel to rest on the conveyor surface to measure the line speed.

HOLLOW SHAFT ENCODER

Calculating the calibration constant—K Factor (pulses/ft)

$$K = \text{PPR} / \text{CIR (ft.)} = \text{PPR} / (\text{PI} * \text{DIA})$$

*Use diameter of drive/tail pulley that encoder is attached to.

$$K = \text{PPR} (*\text{D1}/\text{D2}) / (\text{PI} * \text{D2})$$

*Used with dual pulley configuration. D1—Drive/Tail pulley, D2—Secondary pulley encoder is attached to.

$$\text{Gear ratio} = \text{D1}/\text{D2}$$

HOLLOW SHAFT ENCODER SPECIFICATIONS	
Resolution (PPR)	1024
Output	10-32V HTL/push-pull
Input	10-32V
Bore	5/8" hollow bore w/tether
Collet Inserts Metric	10mm & 12mm
Collet Inserts Standard	3/8" & 1/2"
Enclosure Rating	IP65

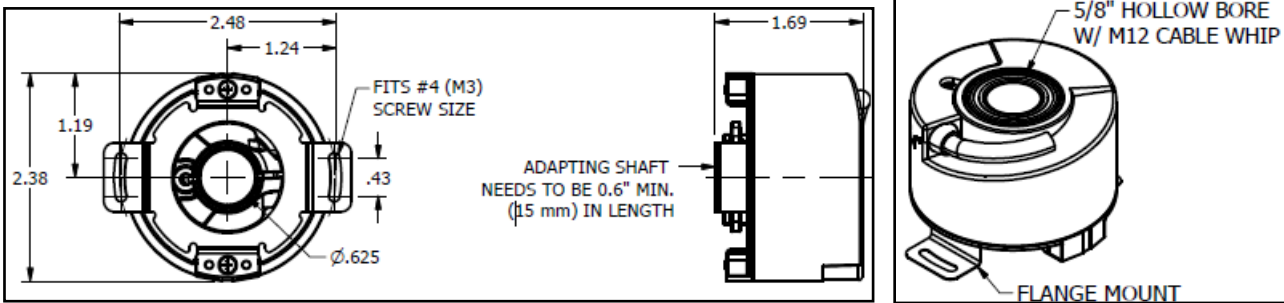

WHEEL AND PIVOT MOUNTED ENCODER

Calculating the calibration constant—K Factor (pulses/ft)

$$K = \text{PPR} / \text{Wheel CIR (ft.)}$$

WHEEL AND PIVOT MOUNTED ENCODER SPECIFICATIONS	
Resolution (PPR)	1024
Output	5-26V push-pull
Input	5-26V
Bore	3/8" sealed shaft
Wheel Circumference (CIR)	12"
Enclosure Rating	IP67 w/shaft seals

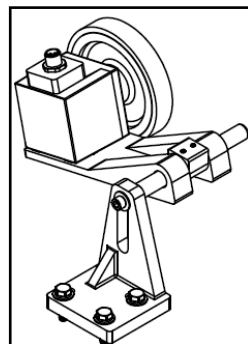
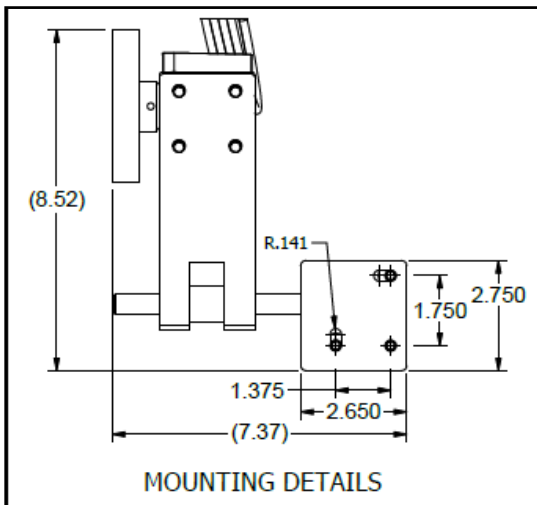

9.3 ENCODER SPARE PARTS

Hollow Shaft Encoder	
Kit Number	060TS06210014W0
Encoder, Thru-Hollow shaft, 5/8" OD Shaft, 10V to 32V HTL/push pull, Cable, 8-wire, 5 m, 1024 Pulses per revolution, IP65 rating.	EN00DFS60BTJEM0
Collet plastic insulated for hollow shaft, shaft diameter 12 mm, outer diameter 5/8" (15.875 mm)	EN002076231
Collet plastic insulated for hollow shaft, shaft diameter 10 mm, outer diameter 5/8" (15.875 mm)	EN002076230
Collet plastic insulated for hollow shaft, shaft diameter 1/2" (12.7 mm), outer diameter 5/8" (15.875 mm)	EN002076227
Collet plastic insulated for hollow shaft, shaft diameter 3/8" (9.525 mm), outer diameter 5/8" (15.875 mm)	EN002076226
Five-meter cable with M12 (f) connectors	LEXXSD4FD4F0050

Wheel and Pivot Mounted Encoder	
Kit Number	060TS06210013W0
Pivot Mount with hardware	EN001113280001
12" circumference measuring wheel, Phenolic w/ 3/8" bore	EN001600
1024 ppr, 5-26 VDC input, 5-26 VDC push/pull output, 5-pin M12 connector, 3/8" single shaft w/seal	EN00221025B546
Five-meter cable with M12 (f) connectors	LEXXSD4FD4F0050



Encoder kit cable: Included in the standard kit for each encoder

FLOW METER(OPTION)

SINGLE AND DUAL CHANNEL ADD ON

The SCS Series flow meter is mounted on a plate. With a single channel 2150+, you will receive the standard single channel flow meter. If you have a dual channel 2150+, you will receive the standard single channel flow meter with a second channel add-on. Flow meters are pre-programmed, but still require origin and span adjustments.

For detailed flow meter setup instructions, refer to the flow meter manual provided with the system.



Flow meter with dual channel add-on

10.1 FLOW METER SETTINGS

Flow meter settings are available with an attached single or dual channel flow meter accessory. Set the input values to match the specifications of the flow meter.

Actual: is read-only and displays the current live readings from the flow meter.

Flow trend: provides a visual representation of the current live readings.

Input: allows you to edit the flow meter specifications.

Alarm:

- **Relative flow limit:** A variable setpoint from the expected flow limit.
- **Absolute flow limit:** A constant setpoint from the expected flow limit.
- **Tolerance time:** The time the flow is outside the alarm settings range before the alarm activates

Note: Flow meter alarm settings are configured when you are setting up the spray parameters in *Configuration* or *Recipes*.



ATTENTION: The 2150+ flow meter is used to display the current live values only. The flow meter data does not affect spray parameters or duty cycle.

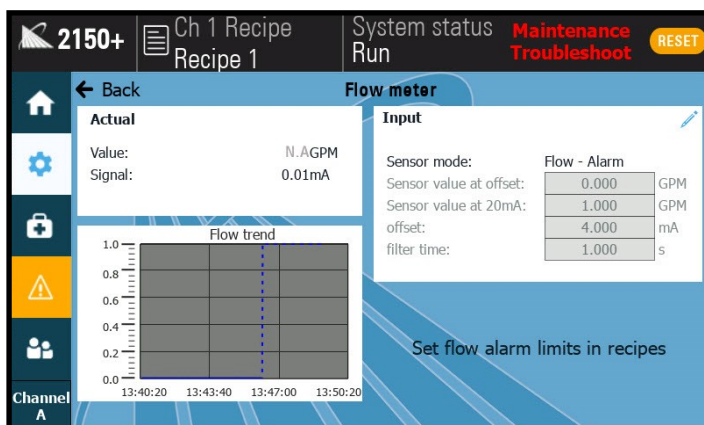

Flow meter settings screen with recipes enabled

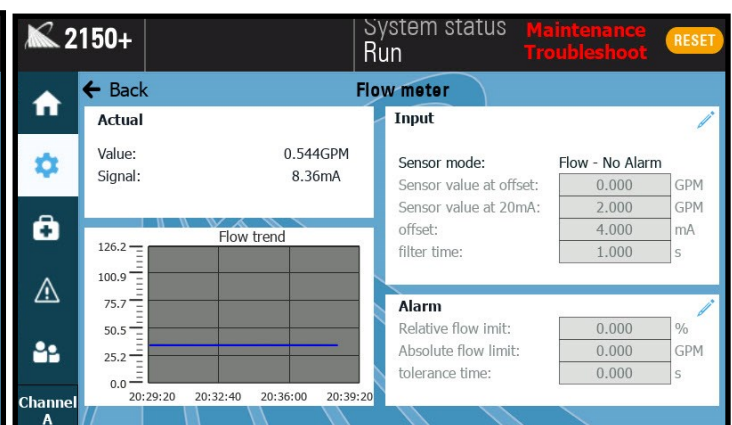

Flow meter settings screen without recipes enabled

INPUT SETTINGS

- **Sensor Scaling:** Adjusts the controller to match the output of the sensor.
- **Sensor mode:** Off (not using flow meter), Flow -- No Alarm, and Flow -- With Alarm.
- **Sensor Value at Offset:** The minimum value of GPM that offsets the starting point that controls pressure sensor.
- **Sensor Value at 20mA:** The maximum value of GPM that the pressure sensor can control.
- **Sensor offset:** The minimum level of the sensor offset that can be controlled usually starting from 0mA or 4mA.
- **Filter time:** Used to control interference/noisy signals from sensor.

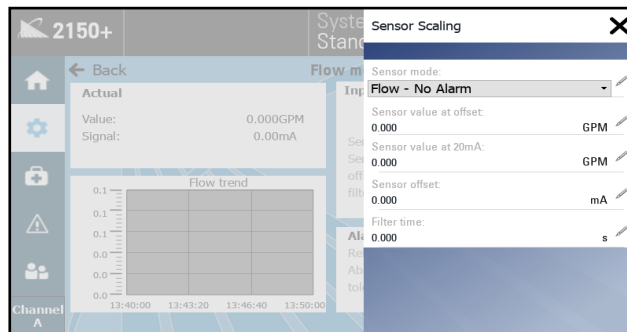

Flow meter Sensor Scaling Mode settings

10.2 ASSEMBLY SPECIFICATIONS

ORIGIN ADJUSTMENT

While the pipe section with the flow meter is filled with fluid and fluid is not moving, press and hold the up and down directional buttons until the origin adjustment screen appears. Use these buttons to select “yes” and then press the mode button and wait while the settings are saved.

SPAN ADJUSTMENT

Span adjust is initially set for water and will need to be adjusted to suit your process fluid. To do this, navigate to the span adjust setting under advanced settings after setting flow tuning to span adjust. Then perform test sprays for a set time and record the mass of fluid sprayed and the volume of fluid reported to the spray control panel. Adjust the span up or down to reflect this measured spray and conform with further test sprays.

- Clamp-on style flow meter
- Overall dimensions: 18" x 12" x 5.5"
- Mounting dimensions: 17" x 11" - 0.34" dia. holes
- Ambient temperature: 14-140°F (-10-60°C)

Fluid Connections:

- Threaded version: 1/2" NTP (F) (Inlet/Outlet)

Flow Rate:

- Maximum: 5.28 GPM (20 L/min)
- Minimum: 0.02 GPM (0.076 L/min)

Color Code: Flow			
Pin #	Color	Description	
1	Brown	+24 VDC	
2	white	N/A	
3	Blue	0V	
4	Black	4-20ma Signal	



Plug and Spray connections, flow meter (located on bottom of 2150+)

10.3 FLOW METER SPARE PARTS

Flow Meter	
Part	Part Number
Cable Glands, Strain Reliefs & Cord Grips LTCG 3/4 NPT 8.5mm SPLIT BLACK	CG00836M3234GBH
Flow Sensor Controller: Main Unit, DIN Mount for FD-X series	FL00FD00XA1
Clamp, Metal Pipe, 10.8mm - 14mm, 1/2" ODT, for use w/ FD-XS20	FL00FDXC20M2
Flowmeter, Ultrasonic, Sensor Head, 0 - 20000 mL/min, clamp on, 2m cable, used w/ FDX controller & FDX clamp	FL00FDXS20
Five-meter cable, M12 (f), M12 (m), 4 wire	LEXXSD4FD4M005P
Standard Key Connector, 4-Wire M12 (m), 18 ga. max., 4A, Field Wire-able	JC00BS81410

SECTION 11

FAULTS AND ALARMS

11.1 FAULTS AND ALARMS SETTINGS



When the fault indicator in the left icon menu is illuminated yellow/orange, the 2150+ has detected that there is a fault present.

Some faults are recoverable, but certain faults can result in the 2150+ entering standby mode. When this happens, triggering signals or events will no longer be accepted until the reason for the fault has been corrected. However, the spray control panel will still display the fault condition on the alarm history screen. Once the fault has been corrected, complete a power cycle of the 2150+ to reset and clear the fault.



Pressing the orange reset button in the top right corner of the screen will also reset any active alarm that occurs due to a recoverable fault.

ALARM HISTORY SCREEN

The alarm history screen will show a record of all past faults. It will list the time that each fault occurred, and will also show the fault description. You can select the time period that you would like to view using the "Duration" drop down menu and pressing "Refresh" to see the updated results.

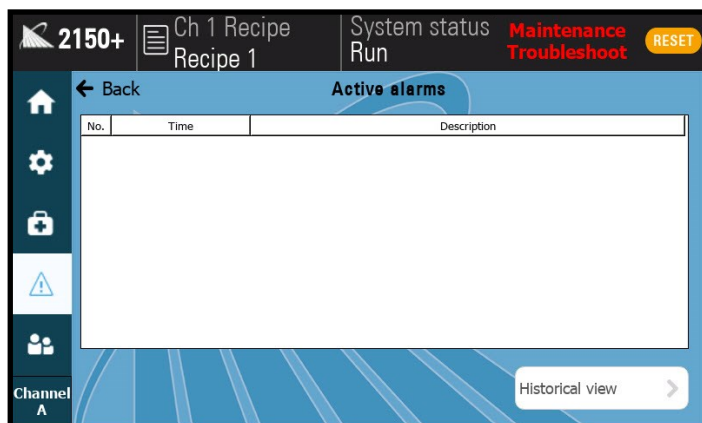

Active alarms screen

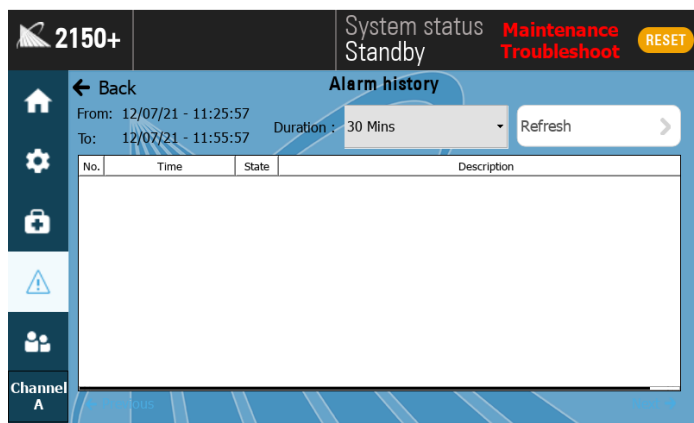

Alarm history screen

MAINTENANCE AND TROUBLESHOOTING

12.1 SETTINGS

The 2150+ is equipped with an internal maintenance scheduler. This allows you to create and set Preventative Maintenance (PM) events. These events can include anything from routine cleanings to specific events like component repair or replacement. Select *Maintenance and Troubleshooting* tab to access PM, a spare parts list, and your Spray Specialist's contact information.

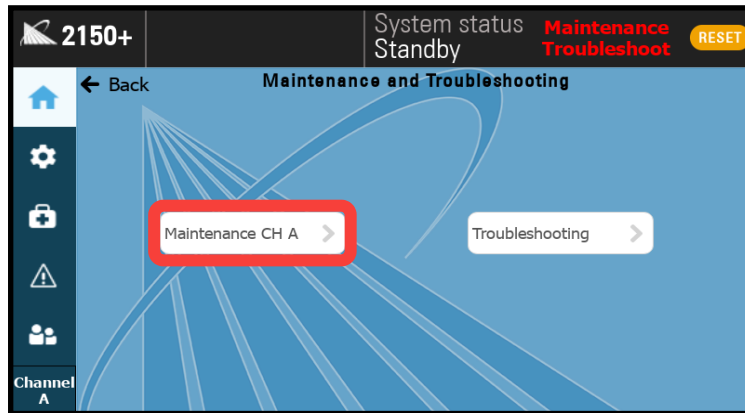

Maintenance and Troubleshooting tab

SCHEDULER TAB

The Scheduler tab will show all upcoming PM events. PM will show the date of next occurrence, and can be toggled on and off. When the PM is due, a notice will show up on the fault screen and the name box will change from green to red. The Scheduler screen can enable or disable PM events by using the button in the "Enable" column. The button will be blue when enabled.

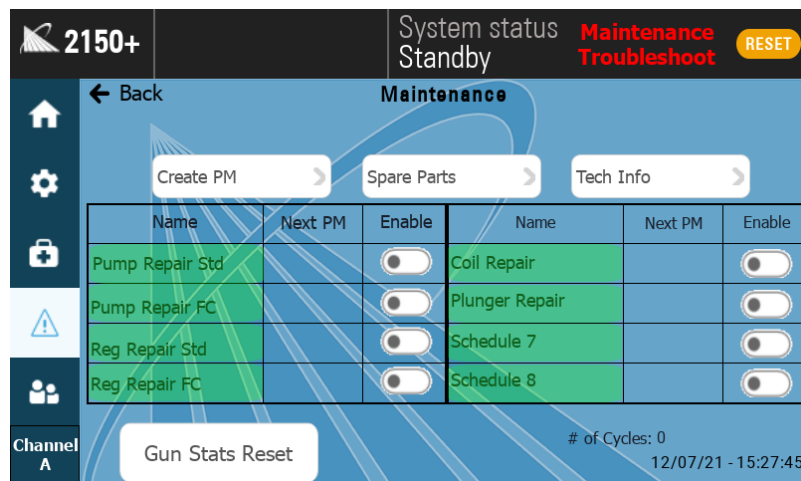

Maintenance Scheduler

CREATE PM TAB

This allows for the creation of PM that will appear on the “Scheduler” tab after the parameters have been created and the “Update PM” button has been pressed. Time frequency of the PM can be set to months or nozzle cycles.

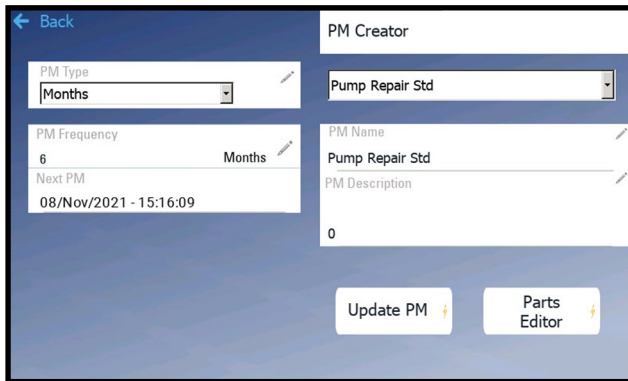

PM creator screen, editing the PM

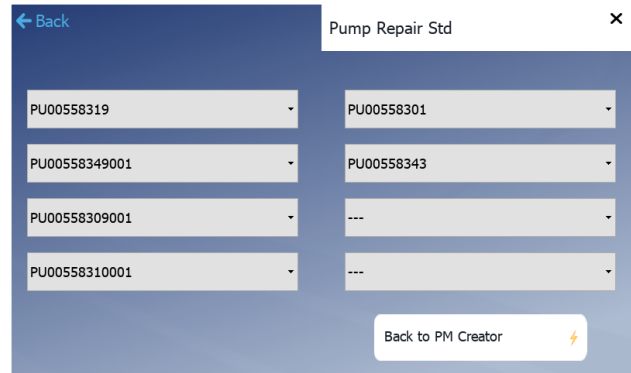

PM Parts List for a Pump Repair Std

SPARE PARTS AND SPRAY SPECIALIST TABS

A complete list of spare parts for your specific system configuration can be found by selecting the *Spare Parts* tab. Parts can be selected from the drop down list. Once selected, a part description can be viewed or edited.

The contact information for your local Spraying Systems Co.® Spray Specialist can be found by selecting the *Spray Specialist* tab. These editable boxes contain the name, phone number and email address of your Spray Specialist.

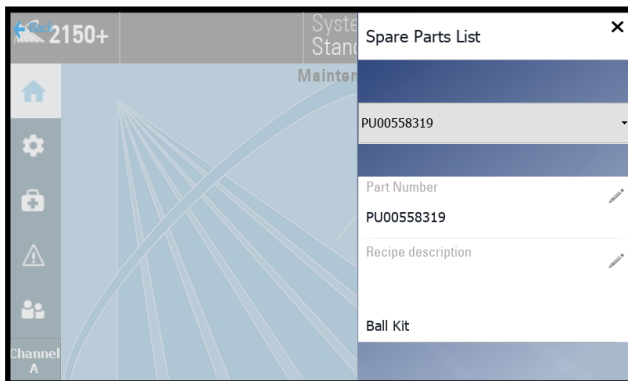

Spare Parts List

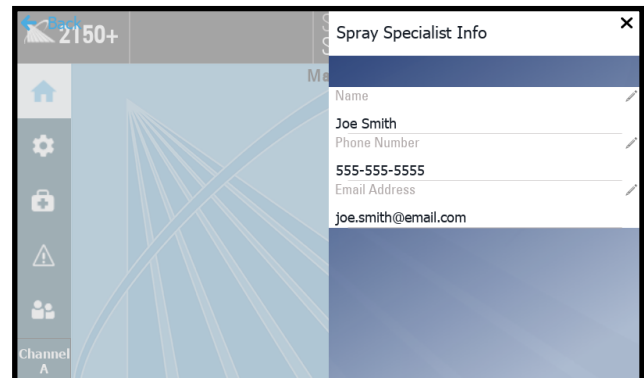

Spray Specialist Info

TROUBLESHOOTING

The 2150+ provides troubleshooting tips for some of the most common issues that may occur. This feature provides some troubleshooting measures you can take to try and resolve the issue before contacting your local Spray Specialist for support. Troubleshooting tab has common system issues to resolve any problems. Once the issue is selected, you will see several prompts. These prompts could suggest an action to perform a system component to check, or direct you to the system manual.

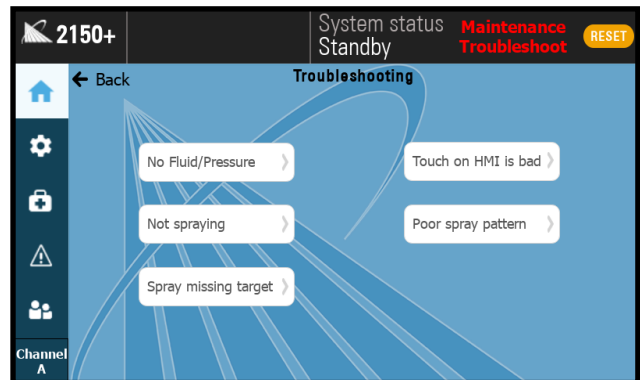
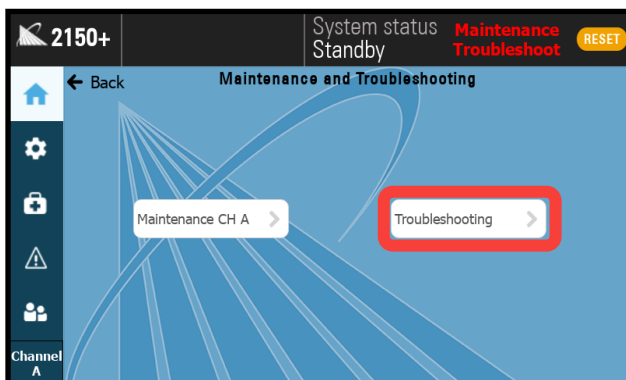

DIAGNOSTICS

The diagnostics tab is a tool to help with system troubleshooting. This screen groups together real-time readings from connected digital and analog inputs and accessories and displays all of the read-only values in one location. These values can help to diagnose the cause of any faults.

See *Faults and Troubleshooting* for more information.

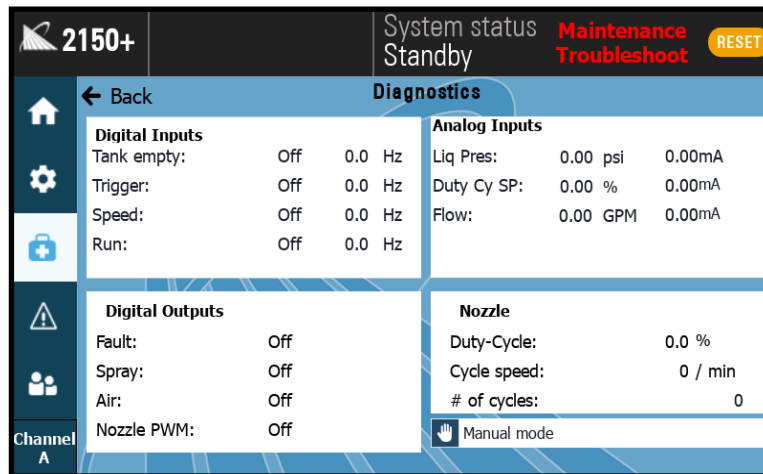

Diagnostics tab

TRIGGER DEVICES AND ACCESSORIES

14.1 ELECTRIC NOZZLE CORD SET

If the system is designed to operate Spraying Systems Co.® PulaJet or AA250 electric actuated spray nozzles, the system is supplied with a cord to connect the spray nozzle to the Control Panels. All the electric actuated nozzle cord sets are wired as shown in the diagram.

AA10000 SERIES PULSAJET NOZZLE CABLE

- Panel connection: Main
- Part number: LEXXSD3M83F030P
- Cable: 9.8 ft. [3 m] cord length
- Connector – M8 3 pin female
- Connector – M12 3 pin male

AA10000 Series Cable LEXXSD3M83F030P

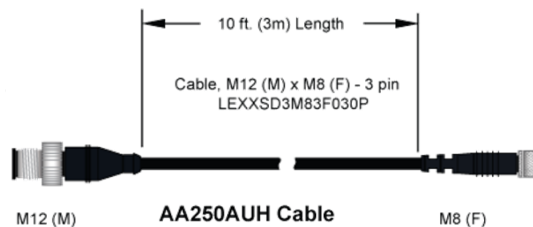

AA250AUH ELECTRIC NOZZLE CABLE

- Panel connection: Main
- Part number: LE00M12MMDIN3MU
- Cable: 9.8 ft. [3 m] cord length
- Connector – Mini DIN
- Connector – M12 3 pin male

AA250AUH Cable LE00M12MMDIN3MU

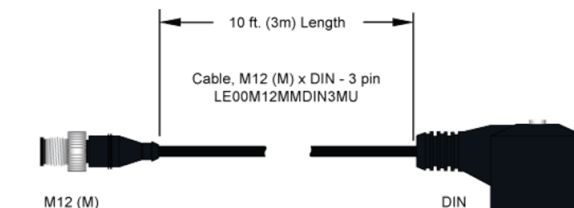

ELECTRICAL JUNCTION BLOCK

If multiple PulaJet or AA250 electric spray nozzles are used the system comes complete with a junction block to connect the spray nozzles to the unit. The junction block is available in two versions: four (4) and eight (8) nozzle connections.



14.2 TRIGGER CABLE

Optional trigger cable offering: Un-terminated flying lead cable and connector.

REQUIRED INPUT

- Part number - LE00M12F5M – M12(f) x bare lead trigger cable
- NPN – Switch to 0 VDC to turn on spray trigger.
 - Requires NPN Sensor or dry contact switch.
- Connects to the connector labeled “Trig.” On the bottom of the panel.

ASSEMBLY SPECIFICATIONS:

- Panel connection: Trig (Software trigger choice - DI2)
- Cable: 16.4 ft. [5 m] cord length
- Flying Leads
- Connector end—M12 4 pin female



Trigger cable

Note: Connect pins 3 & 4 with a switch or dry contact relay to initiate trigger.



WARNING: Never connect pin 1 (24vdc) to any other pin unless you are wiring in your own 24VDC sensor. Doing so could cause equipment damage. (Cut the brown and white wire if you're not using them.)

Color Code: Trigger		
Pin #	Color	Description
1	Brown	+24 VDC (only used for sensors)
2	white	Not Connected
3	Blue	0VDC
4	Black	DI2

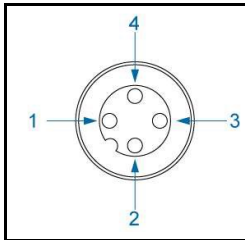

Note: Do not supply pins 2 or 5 with the 24V model.

14.3 PHOTOELECTRIC OBJECT SENSOR

Infrared – direct reflection sensor with cable and connector, this is our standard sensor offering, it should work in most cases.

SPECIFICATIONS:

- Kit number: 040TS04000014W0
- Photoelectric sensor – Infrared – direct reflection sensor with cable, connector, and bracket.
- NPN – NO + NC
- 35 inch [900 mm] sensing range
- Setting distance adjustable between 6 and 36 inches [150 and 900 mm]
- Working temperature range = -4°F to 158°F [-20°C to 70°C]
- IP67; CE rated

ASSEMBLY SPECIFICATIONS:

- Panel connection: Trig
- Cable: 16.4 ft. [5 m] cord length
- Connector – M12 4 pin female

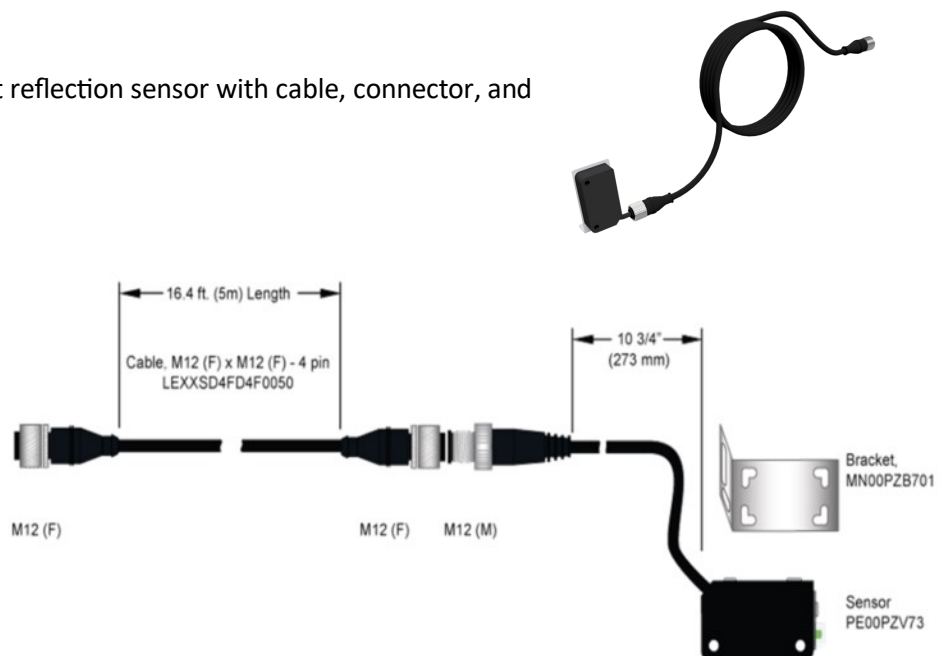

14.4 COLOR SENSOR

Full-Spectrum color, detects color/brightness/surface finish/intensity, NPN/ PNP, IP65/ IP67 rating, 1.18 to 19.69 in. detectable distance.



14.5 PROXIMITY SENSOR

For sensing metallic objects. Kit includes sensor, with mounting nuts and locking washer, and cable.

SPECIFICATIONS:

Proximity sensor – Detects all metals 10mm max. sense dist., 24vdc, NPN outputs N.O./N.C., shielded, IP67, 5m cable wired

- Kit number: 040TS04000118W0
- NPN – NO + NC
- Working temperature range = -13°F to 176°F [-25°C to 80°C]
- IP67, NEMA type 6 (waterproof); CE rated



14.6 TRIGGER INTERLOCK

SCS Series spray control panels feature an optional secondary run enabled trigger (Trigger Interlock feature) or a digital input for a level switch.

For the secondary run trigger (DI4), this feature provides a way for you to provide a run signal to the spray control panel. If this signal is not present, then the system will ignore the trigger signal. An example of this would be if you do not want the nozzle to spray unless the conveyor is running and there is a part present to spray. This input always goes to 0V, pin 3. To activate this feature on the HMI, go to settings/trigger and pick trigger source DI2+DI4.

For the level switch option (DI1), this feature allows you to wire in a normally open or normally closed level switch from a liquid tote or tank. When the tank runs low and the level switch contact closes or opens, the spray control panel will display a fault. To use these features, you need our cable part number LE00M8F5M. This input always goes to 0V, pin 3. To activate this feature on the HMI, go to settings/tank level and turn on under level sensor.

SPECIFICATIONS:

- Kit number: LE00M8F5M
- Panel connection: T. int.
- Cable: 16.4 ft. [5 m] cord length
- Flying Leads
- Connector end – M8 4 pin female

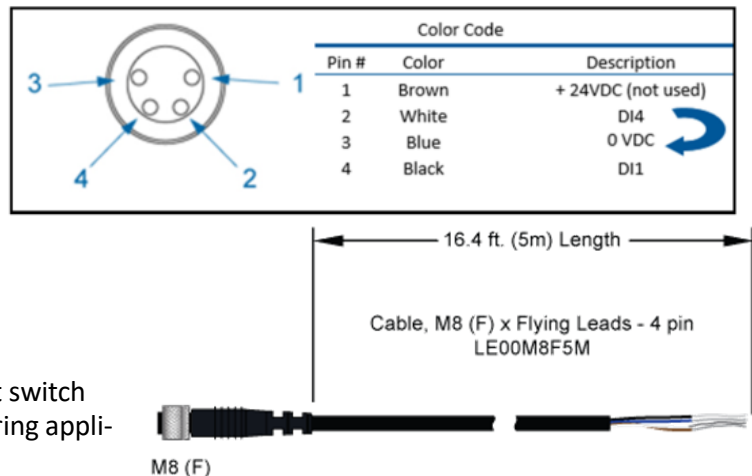

14.7 FOOT SWITCH

For manual triggering of the system. Heavy duty foot switch provides for hands free triggering in a manual triggering application.

SPECIFICATIONS:

- Kit number: 040TS04000130W0
- Momentary on switch
 - Wired normally open (can be wired normally closed)
- M12 (F) connector – connects to “Main” on control panel - 4 pin
- 16.4 ft (5m) cable length

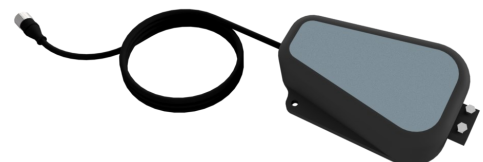

14.10 LASER SENSOR (SHORT)

For accurate short distance sensing of objects (thin, shiny, dark, clear, multi-faceted). Connect correct ends.

SPECIFICATIONS:

Laser sensor – with cable, connector, and bracket.

- Kit number: 040TS04000135W0
- NPN – NO + NC
- 1.0" – 3.5" [25mm – 90mm] sensing range (1.5mm – 3mm deviation range).
- Working temperature range = 10°F to 122°F [-10°C to 50°C]
- IP69K, NEMA 4X; CE rated
- Mounting bracket, accurate short sensing distances of 25 to 90 mm, std. detectable deviation 1.5-3.0mm, NPN/PNP open collector, 24Vdc, M12 4 pin male connection, 5m cable.

14.11 LASER SENSOR (LONG)

For accurate long-distance sensing of objects (shiny, dark, clear, multi-faceted)

SPECIFICATIONS:

Laser sensor – with cable, connector, and bracket.

- Kit number: 040TS04000087W0
- NPN – NO + NC
- 1.38" – 19.69" [35mm – 500mm] sensing range (9mm – 50mm deviation range).
- Working temperature range = 10°F to 122°F [-10°C to 50°C]
- IP69K, NEMA 4X; CE rated
- 5m cable, and mounting bracket, 24Vdc, NPN. IP68/ IP69K.

14.12 FAULT OUTPUT SIGNAL

The SCS Series spray control panels offer a feature to signal your system when a fault has occurred in the operation of the spray control panel (for example a level sensor going low or a short in one of the nozzle cables). To use this feature, you need to have our optional splitter cable kit.

Wire the fault output to any 24VDC buzzer, light, or PLC. You will need the splitter and the extra cable shown below.

- Kit 040TS04000054W0 includes both parts.

This end goes in the Main connector on the 1750+ panel. The black and the white wires from the flying leads cable get wired to your PLC or light or buzzer, snip the blue and brown wires, they are not used. Fault cable pinout below:

If any electric nozzles are used, they get hooked up to the open M12 connector on the wye connector.

- Panel connection: Main
- Cable: M12 4 pin (M) x Flying Leads - 16.4 ft. [5 m] (Connects to one connector on splitter), flying leads (Part number: LE00M12M5M)
 - The flying leads from cable of the kit are to be connected to the customer's PLC or warning signal light, +24VDC. (black and white wires)
- Adapter: Splitter – M12 (M) x 2 M12 (F) - 3 ft. [1 m] whip cord length (Part number: LE00M12WYE1M)
- Open connector on splitter
 - Connect PulsaJet cable; AA250 cable; or extension cable to this connection.

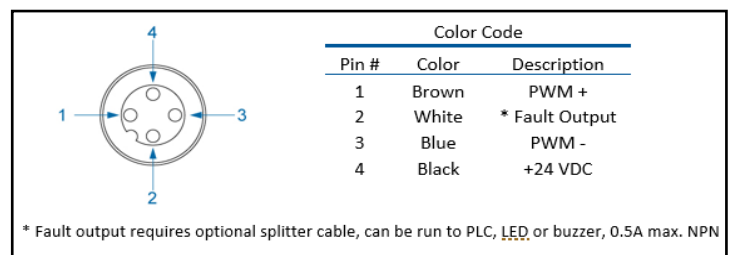

**Fault Output Signal Kit
040TS04000054W0**

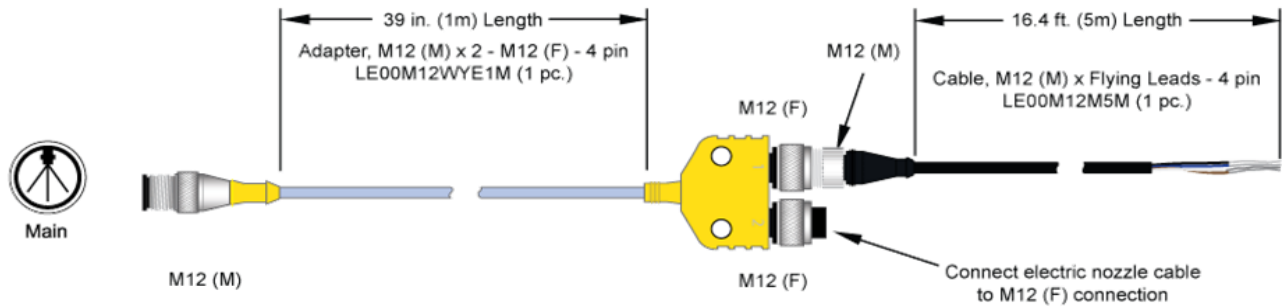

14.13 FAULT OUTPUT CABLE KIT

The 1750+ and 2150+ offer a feature to provide a signal when a fault has occurred during operation. This is wired as shown in the table below. To use this feature, you need to have our optional splitter cable kit.

- Panel connection: Main and T. int.
- Kit number: 040TS04000064W0
- Adapter: Splitter- wye, M12, 4 pole, trunk = male M12 1m whip, 2 branches x M12 female coupling nuts, TPU, parallel wiring. (Part number: LE00M12WYE1M)
- Cable: Main, M12 (M) x Flying Leads - 16.4 ft. [5 m] cord length, bare leads, M12 4 pin (M), 4 wire. (Part number: LE00M12M5M)
 - Connects to one connector on splitter
 - The flying leads from cable of the kit are to be connected to the customer’s PLC or warning signal light, +24VDC. (black and white wires)
- Open connector on splitter
 - Connect PulsaJet cable; AA250 cable; or extension cable to this connection.

Color Code		
Pin #	Color	Description
1	Brown	PWM +
2	White	* Fault Output
3	Blue	PWM -
4	Black	+24 VDC

Fault Output signal max. 30v/1A NPN

**Level Switch Cable Kit
040TS04000064W0**

Level Switch cables

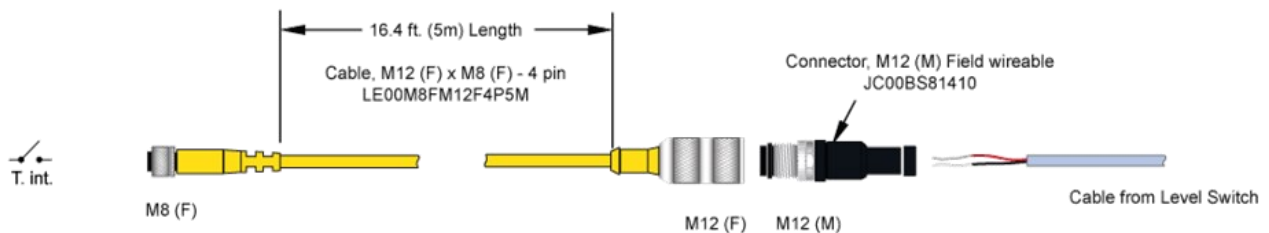

Fault Output cables

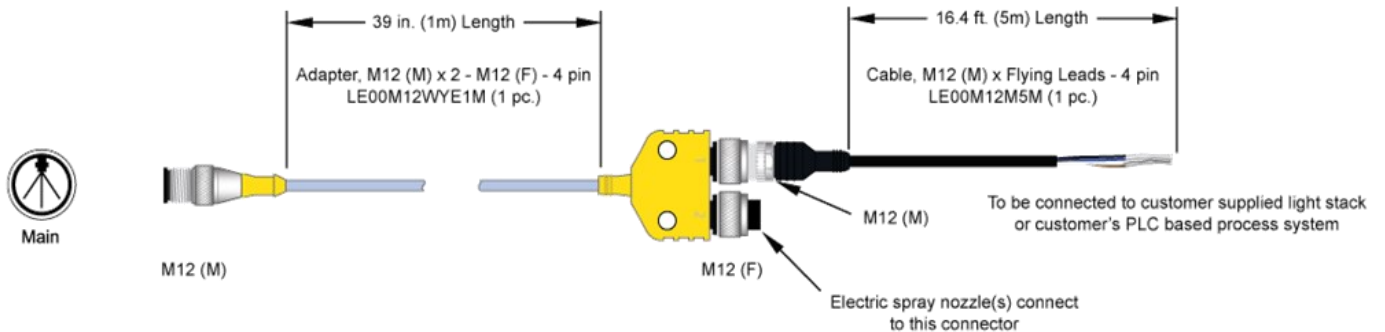

14.14 EXTENSION CABLE

If longer length cables are required, an extension cable is available that can be used to go between the nozzle cable and the junction block or the junction block cable and the system. This cable can also be used to extend the trigger device cable lengths.

This cable can be used to go between the nozzle cable and the junction block or the junction block cable and the system or extend the trigger device cable lengths. When using to extend electric nozzle cables, connect electric nozzle cable to M12 (F) connector. When using to extend electric nozzle cables, M12 (M) connects to “Main” connector on the control panel or junction block. When using to extend sensor cables, connect M12 (F) connector to “Trig” connector on the “Trig” Control Panel. When using to extend sensor cables, connect M12 (F) connector from sensor cable to M12 (M) connector of the extension cable.

Note: Due to voltage drop we recommend keeping the cable length to a reasonable length. Never attempt to chain more than four (4) cables together. Electric spray nozzle speed and performance will suffer.

- Part number: LEXXSD4FD4M005P
- Connect to Main or Trig on control panel
- Cable: 16.4 ft. [5 m] cord length
- Connector – M12 4 pin female
- Connector – M12 4 pin male

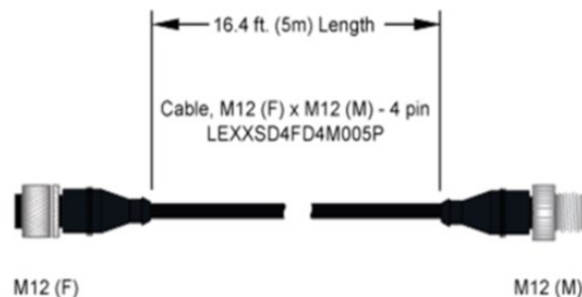

14.15 INPUT SIGNAL

Optional Input signal offering consists of a cable with connector and flying leads to be connected to the customer's conditioned 4-20 mA signal to remotely control the PWM (Pulse Width Modulation) feature of the spray control panel. This will allow the duty cycle to adjust according to the input signal. 4mA corresponds to a 0% duty cycle and 20 mA corresponds to a 100% duty cycle.

For the spray indicator digital output (DO2), wire to pins 1 and 2 (brown and white wires). This output is active only when the system is triggered, it can be sent to a PLC for spray verification.

ASSEMBLY SPECIFICATIONS

- Panel connection: 4-20mA
- Part number: LE00M8M5M
- Cable: 16.4 ft. [5 m] cord
- Flying Leads
- Connector – M8 4 pin male
- Connect to “4-20mA” connection on control panel

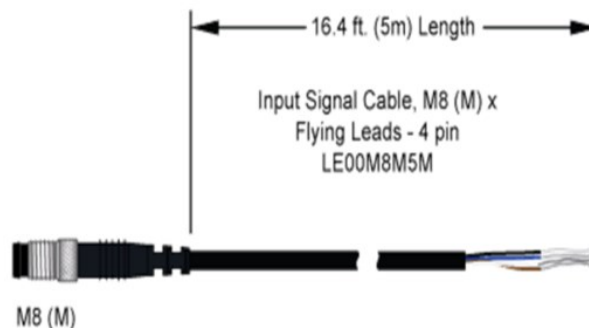

		Color Code	
Pin #	Color	Description	
1	Brown	+24 VDC	
2	White	DO2	
3	Blue	0 VDC	Note: If your 0VDC is coming from a power supply outside of our panel (PLC), connect it to this wire – Pin #3
4	Black	4-20mA	

14.16 LEVEL SENSOR INPUT

A level switch (any normally open or normally closed float switch) can be wired to the system, so when the tank level drops below a certain level, a fault will be shown on the HMI.

Wire the level sensor/float switch to the panel utilizing the cable shown below. You will only use the black and blue wires (dry contacts - polarity not important), carefully cut back and tape the brown and white wires. Run the cable back to the spray control panel and plug into the port labeled "T. Int.".

Activate level sensor option, go to settings in the HMI then "Tank level" and turn on.

Specifications:

- Part number: LE00M8F5M.
- Panel connection: T. int. (Software - DI2+DI4)
- Cable: 16.4 ft. (5 m) cord length
- Flying leads
- Connector end - M8 4 pin female
- Cable, M8 Female, 4 pole, bare leads, 5 meter

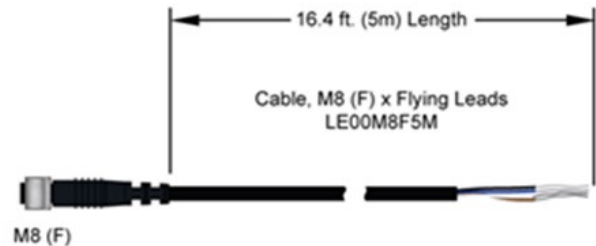

		Color Code	
Pin #	Color	Description	
1	Brown	+ 24VDC (not used)	
2	White	not used	
3	Blue	0 VDC	
4	Black	DI1	

14.17 TRIGGER DEVICES OVERVIEW

Trigger Devices				
ID	Trigger Method	Part Number	Cable Length	Description
1	Customer Supplied	040TS04000056W0	5 m	Trigger cable - M12 female, 4 pole, bare leads
2	Hand Pendant	040TS04000057W0	5 m	Hand-held trigger device
3	Foot Switch	040TS04000130W0	5 m	Foot switch trigger device
4	Object Sensor - Photoelectric	040TS04000014W0	5 m	Detectable Distance - 0.79 to 35.43 in., mounting bracket included, IP67 Rating, NPN output
5	Object Sensor - Thru-Beam	040TS04000028W0	5 m	Detectable Distance - 65.6 ft, mounting brackets included, IP67/IP69K rating, NPN output
6	Laser Sensor - Short Distance	040TS04000135W0	5 m	Detectable Distance - 0.98 to 3.54 in., mounting bracket included, IP68/ IP69K rating, NPN/ PNP output
7	Laser Sensor - Long Distance	040TS04000087W0	5 m	Detectable Distance - 1.38 to 19.69 in., mounting bracket included, IP68/ IP69K rating, NPN output
8	Proximity Sensor	040TS04000118W0	5 m	Ferrous metals, 10 mm (0.39 in.) detectable distance, NPN Open collector, IP67 rating
9	Color Sensor	040TS04000179W0	5 m	Full-Spectrum color, detects color/brightness/surface finish/intensity, NPN/PNP, IP65/ IP67 rating, 1.18 to 19.69 in. detectable distance
10	Trigger Adapter - Dual Channel	070TS07000051W0	5.3 m	Single Trigger Splitter for Dual Channel Systems

NOTE: CONTACT A SALES ENGINEER TO DETERMINE WHICH SENSOR BEST FITS YOUR APPLICATION AND SYSTEM CONFIGURATION.

WARNING
Trigger device IP rating only applies when all cables are properly connected and secure

DESCRIPTION:
Spray Control System (SCS) Series
Trigger Devices

REVISION NO. 1
REFERENCE: 1
SHEET: 1 OF 1
DWG SIZE: B

FAULTS AND TROUBLESHOOTING

FAULT	CAUSE	SOLUTION
Liquid Pressure Sensor	Wire break detected	Check Wiring, Verify sensor is receiving power. Check cable continuity.
4-20mA Remote Setpoint	Remote 4-20mA setpoint wire break detected	Check Wiring, Verify sensor is receiving power. Check cable continuity. Verify 4-20 signal.
Analog Flow Meter	Flow sensor wire break detected	Check Wiring, Verify sensor is receiving power. Check cable continuity.
Current+	Current on PWM+ exceeds limits (high)	Current draw exceeds limits, verify current specifications are not being exceeded with too many nozzles or accessories.
Current-	Current on PWM- exceeds limits (low)	2150+ is not getting enough current, Verify input AC/DC power is sufficient.
Temperature	Max. controller operating temperature exceeded	Must not operate about an ambient temp of 104°F. Fan must be running at all times during operation.
High Voltage	Input voltage too high	Verify correct power is being supplied to the 2150+.
Low Voltage	Input voltage too low	Verify correct power is being supplied to the 2150+.
Current Open	Open circuit detected on PWM output	Verify wiring to the nozzles.
Current Ground	Ground fault leak detected on PWM output, check wiring for damage	Confirm wiring is only going to PWM+ and PWM-. Verify 2150+ is not damaged.
Current	High current draw detected on PWM output	Verify correct number of nozzles are being used according to specifications.
Pressure High	Spray pressure is too high	Lower the pressure, make the pressure more stable, set the maximum alarm pressure parameter to a higher value or disable the pressure input.
Pressure Low	Spray pressure is too low	Increase the pressure, make the pressure more stable, set the minimum alarm pressure parameter to a lower value or disable the pressure input.
Tank Empty	Liquid tank is empty	Refill liquid tank, verify level is operating as intended.

FAULT	CAUSE	SOLUTION
External 1	Fault 1 triggered remotely	Custom faults, See internal systems controls for details
External 2	Fault 2 triggered remotely	Custom faults, See internal systems controls for details
Trigger Check Sensor 1	Unexpected trigger check signal received	Verify trigger is operating at rated specifications.
Trigger Check Sensor 2	Trigger check Signal was not verified in time	Trigger device signal is not long enough. Increase duration of the trigger.
Nozzle Cycle Limit	Nozzle cycle count has reached a service warning limit	Nozzle is at max cycle limit --- refer to nozzle specifications for proper cycle rates
Flow Higher	Flow is higher than expected	Adjust pressure or duty cycle to lower/raise flow rates.
Flow Lower	Flow is lower than expected	Adjust pressure or duty cycle to lower/raise flow rates.
Schedule 1-8 PM CH A	CH A maintenance reminder	Refer to maintenance schedule and contact spray specialist if needed.
Schedule 1-8 PM CH B	CH B maintenance reminder	Refer to maintenance schedule and contact spray specialist if needed.

HMI COMMUNICATION FAULT

You will see small yellow triangles on the screen. Note this error occurs if the HMI is not communicating with the nozzle driver control board. Consult your Spray Specialist if a reboot doesn't fix the issue.

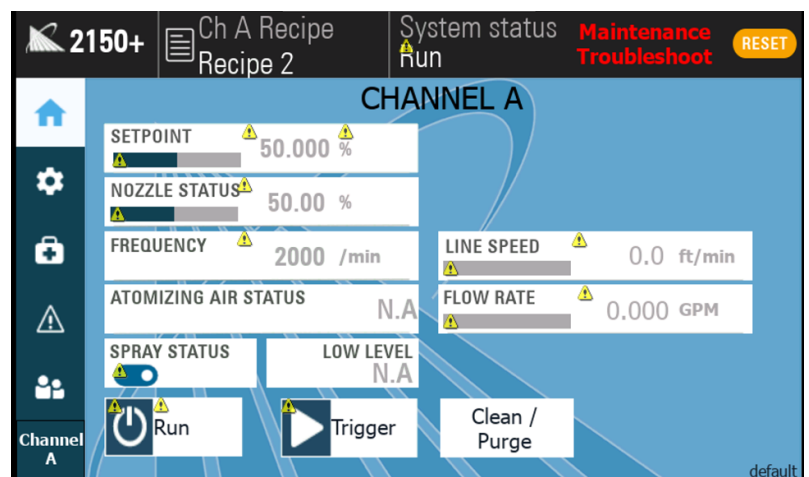

FAULTS AND SOLUTIONS:

- Controller will not power up and the main power indicator (RED LED) does **NOT** illuminate.
Ensure power cord is plugged into controller and power outlet and power switch is in the “on” position.
—Follow these steps to check fuse on internal power rail:
 - 1) Unplug the system.
 - 2) Remove four (4) screws in the corners of the Pane Cover plate (using #2 Phillips screwdriver).
 - 3) Carefully remove plate. Take care to not put stress on the wires.
 - 4) Check the panel for any loose wires.
 - 5) Locate the fuse holder to the right of the power supply and lift the tab on the top of the fuse holder exposing the fuse.
 - 6) Due to the type of fuse used, a qualified electrical technician should test the fuse and replace if necessary (5-amp slow blow).
 - 7) Replace plate to its original location and attach using the four (4) screws.
- If the controller still will not power up, contact your local Spray Specialist.

- Controller will not power up, yet main power indicator light (red LED near power switch) **DOES** illuminate.
 - Follow these steps to check power connection on the HMI:
 - 1) Unplug the system.
 - 2) Carefully open the panel. Take care to not put stress on the wires or scratch the HMI screen.
 - 3) Ensure that there are no loose wires in the system.
 - 4) Close the panel
 - If the controller still will not power up, contact your local Spray Specialist.
- Controller will not operate spray nozzle.
 - 1) Ensure proper fluid pressure is supplied to the nozzle.
 - 2) Ensure the system is recognizing your trigger input. This is a common problem. If remote trigger/sensor is being used and button on the setup screen is set to “local”, the system cannot be recognized, the system trigger needs to be set to something other than “local”. The inverse is also true, if the system is being triggered off the HMI screen, the trigger option must be set to “local”. Make sure your sensor is NPN design if you are using your own sensor.
 - 3) Ensure that the trigger mode is set to Local, DI2 or DI1+ DI2.
 - 4) Navigate to the diagnostic screen.
 - 5) Activate the main trigger source (object sensor or equivalent): DI2 on diagnostic screen should go from a value of 0 to a value of 1 when the trigger device is activated.
 - If this does not occur, then ensure that the trigger device is properly wired.
 - If problem still occurs, then consult the manufacturer’s manual for the trigger device.
 - 6) If trigger mode is DI1+ DI2, activate the auxiliary trigger: DI1 on diagnostic screen should go from a value of 0 to a value of 1 when the trigger device is activated.
 - If this does not occur, then ensure that the trigger device is properly wired.
 - If problem still occurs, then consult the manufacturer’s manual for the trigger device.
- For electrically actuated spray nozzles:
 - 1) Check that the nozzle cable is properly installed on both ends with no damage to the cable.
 - 2) Set duty cycle to 100% from main screen and attempt to trigger again.
 - If the nozzle activates, you may have selected a duty cycle too low or max frequency too high for the nozzle you are using.
 - If the problem persists, have a qualified electrical technician ensure that there is 24 VDC on the nozzle cable when the system is triggered.
- For pneumatically actuated spray nozzles:
 - 1) Ensure that there is a minimum of 45 psi (3.1 bar) of air pressure on the main air input to the system and that the main air valve is in the “on” position.
 - 2) Check air supply.
 - 3) Ensure that the valve cable is connected to the main output on the controller.
 - 4) Remove Cylinder air tube from outside port of the system.
 - 5) Trigger the system to see if air comes out of the port.
 - 6) Take caution to keep your face away from the port to avoid debris entering your eyes.
 - 7) If air comes out, there is an issue with the cylinder on your nozzle. Contact your local Spray Specialist for information on repairing or replacing your nozzle.
 - If no air comes out, contact your local Spray Specialist to order a replacement air valve.

15.1 INTERNAL COMPONENTS

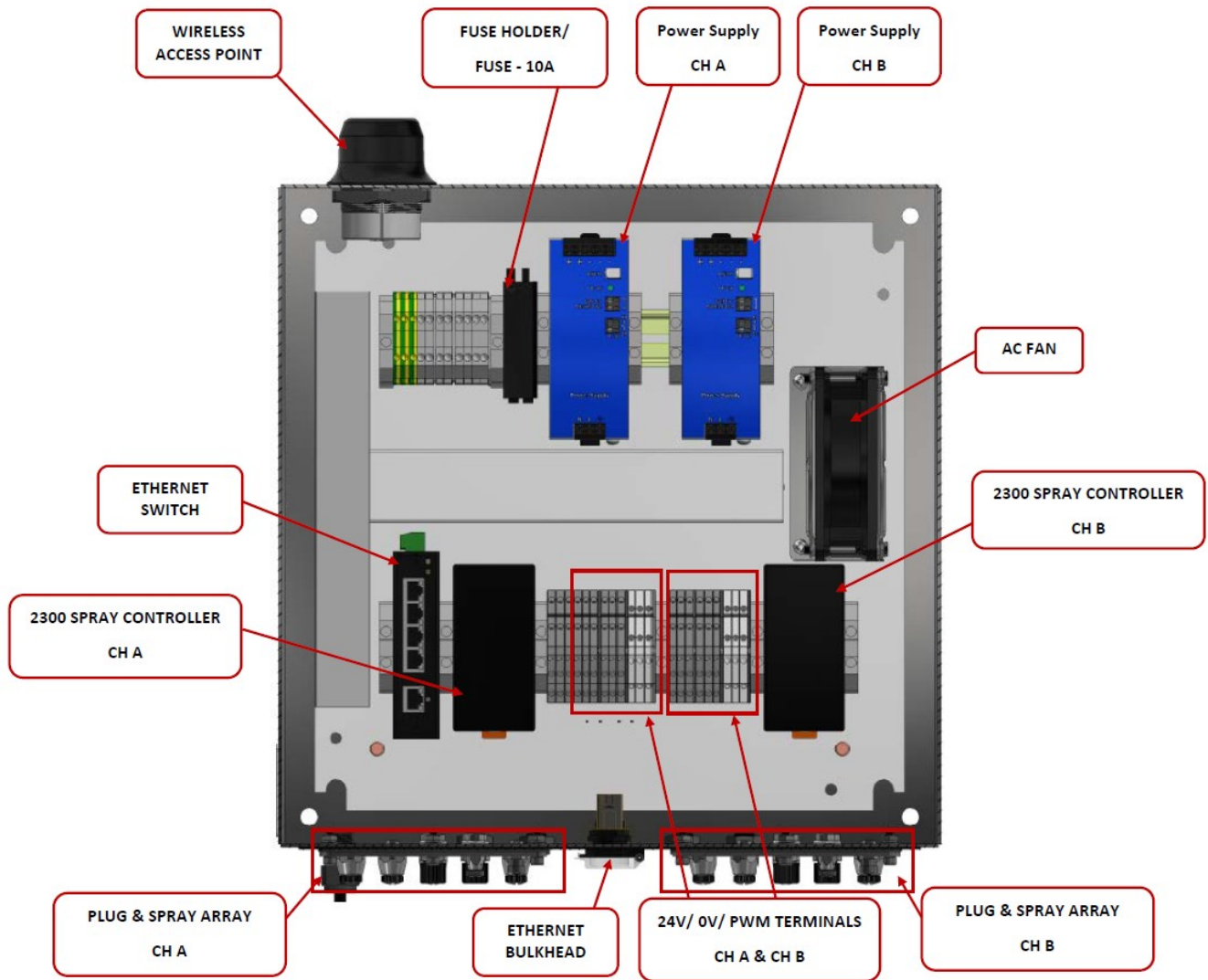

Internal Wiring			
DI1	Level Switch	DO2	Spray Status
DI2	Trigger	DO3	Air
DI3	Encoder	DO4	SYNC Output
DI4	Run/Standby	AI1	Duty Cycle
AI1	Pressure	AI2	—
AI2	Remote Setpoint	Di-select	NPN vs. PNP
AI3	Flow Meter	24V/0V	24V/0V
AI4	—	PWM +/-	PWM Output
DO1	Fault	VIN +/-	Power Supply

ETHERNET IP MANUAL (OPTIONAL)

Ethernet I/P control is available as an additional item on the 2150 controller. Ethernet I/P is a communication protocol that allows for easy data transfer from a main controller to auxiliary devices. The 2150 can be controlled and monitored via Ethernet I/P.

16.1 Studio 5000 Import Example

Included with your Ethernet I/P package is a pre-configured EDS File that will allow for easy setup of Ethernet I/P addressing. Copy the included EDS file to a computer which has Studio 5000 installed on it and follow the below steps.

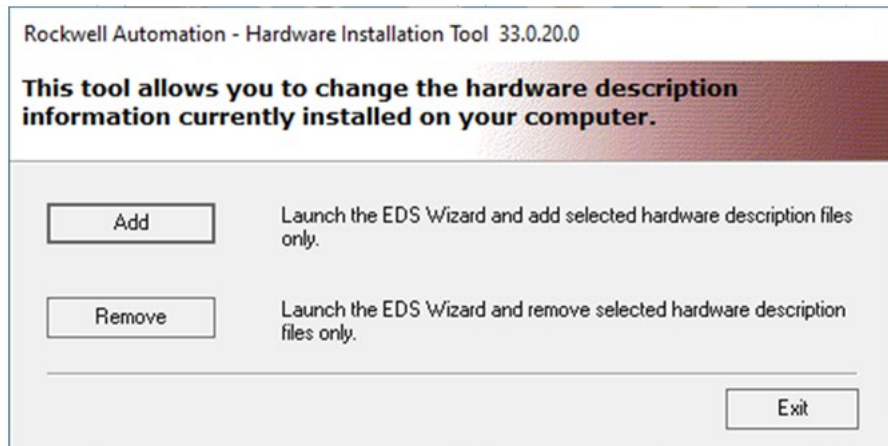

1. Open the Hardware Installation Tool and select *Add EDS File*.
2. Select Register a single file and select the EDS file included on the flash drive. Press *Next*.

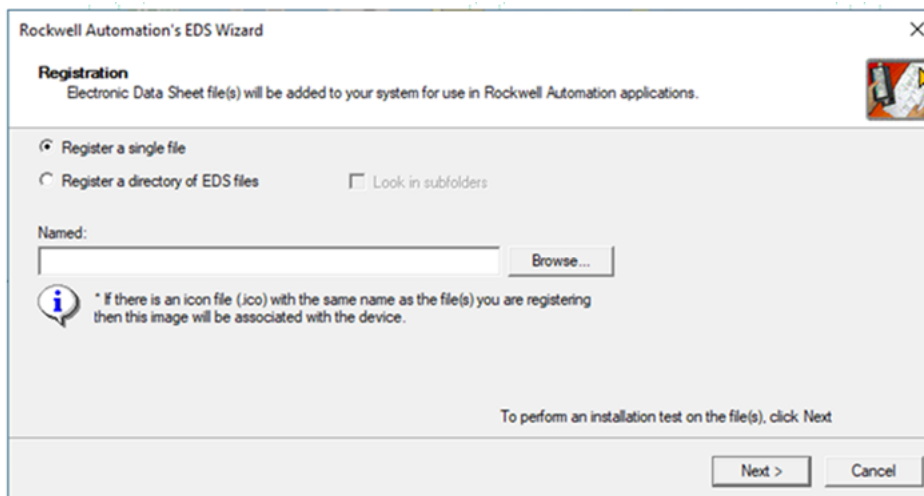

 005A002B00370100.EDS	10/27/2021 3:02 PM	EDS File	18 KB
--	--------------------	----------	-------

3. Verify the file is the correct format for your installation. Press *Next*.

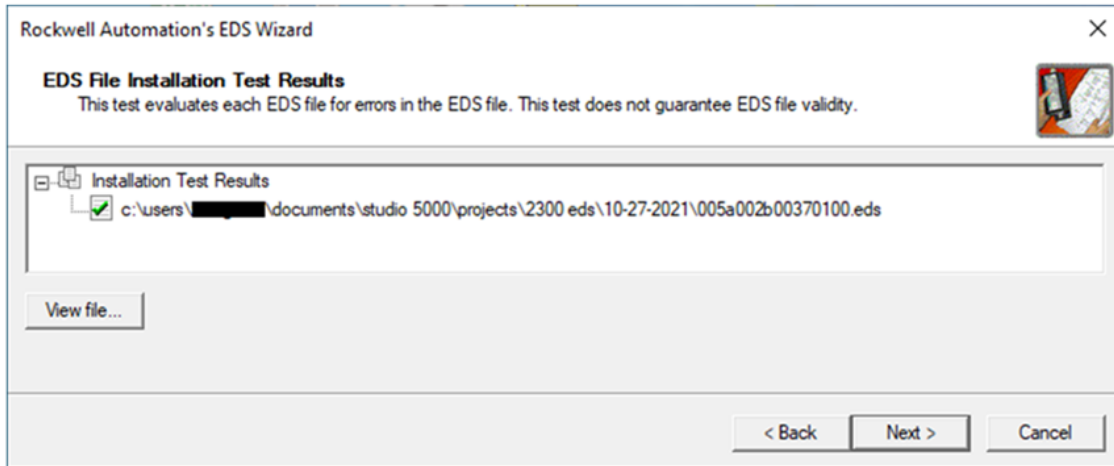

4. Verify it is detected as a CompactCom 40 EtherNet/IP type.

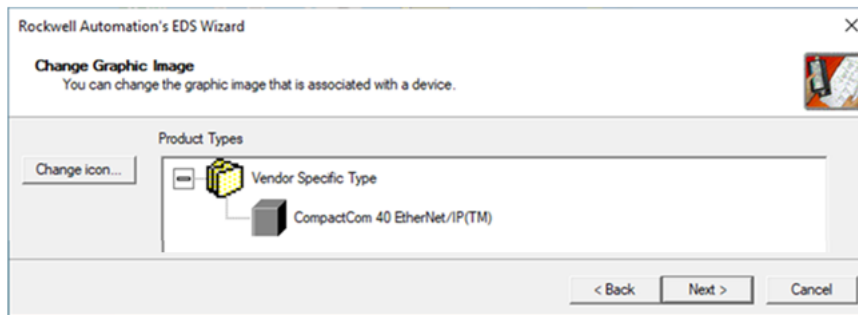

5. Once verified, register the EDS file.

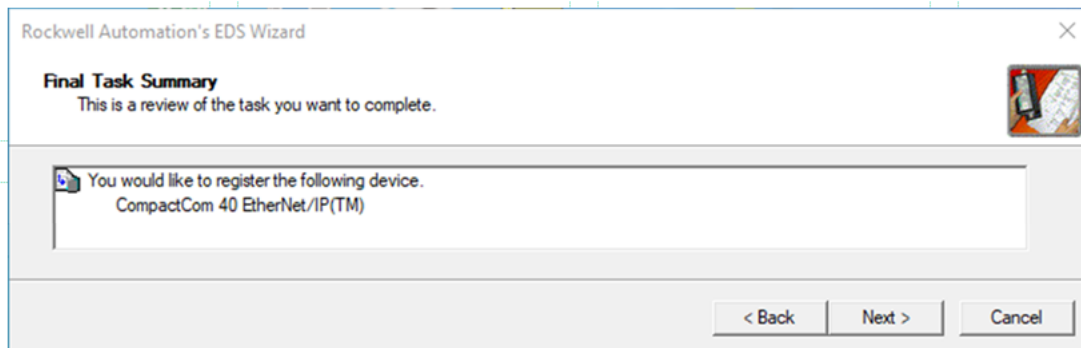

6. Press Finish to complete.

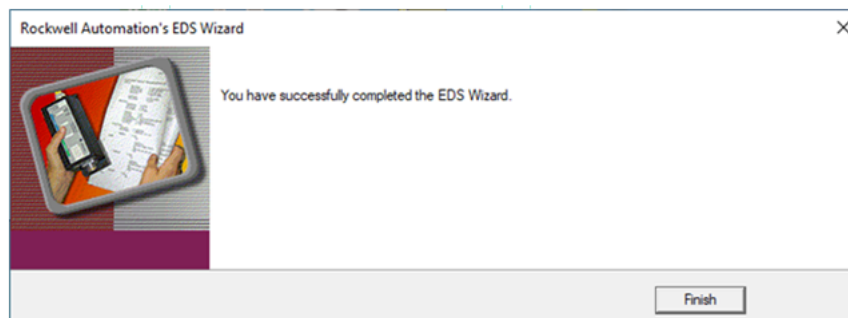

16.2 LOADING THE REGISTERED EDS FILE

After setting up the EDS file, you must import it. Once Imported you will be able to access variables similar to accessing registers in a PLC. These new array tags will be how you control and monitor the 2150 via Ethernet I/P.

1. Select your Ethernet IP tree and select New Module.

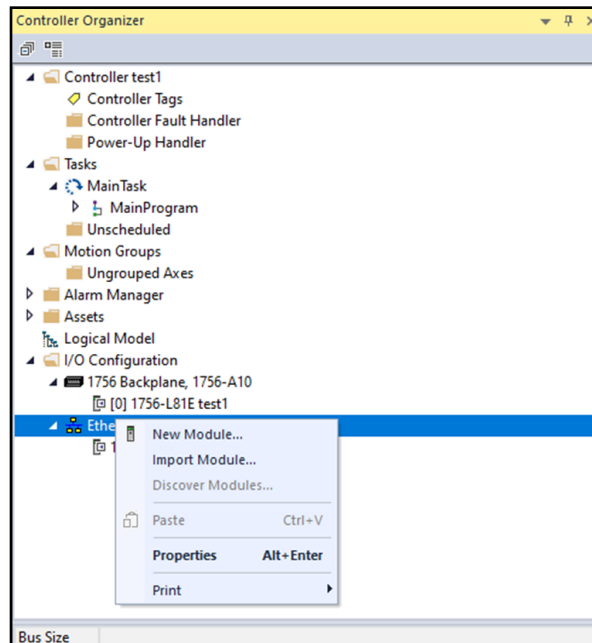

2. Select CompactCom 40 Ethernet/IP as the Module Type.

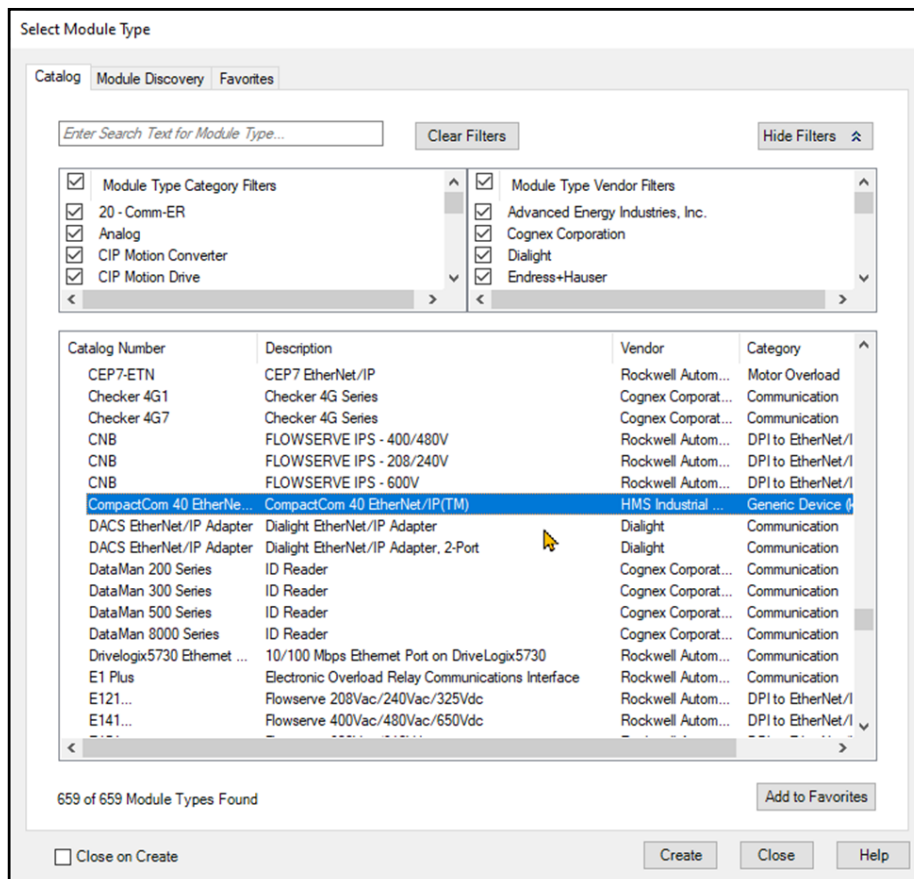

- Give the New Module a descriptive name and an IP Address that matches the base IP address used on the spray controllers. Default: 192.168.0.XX.

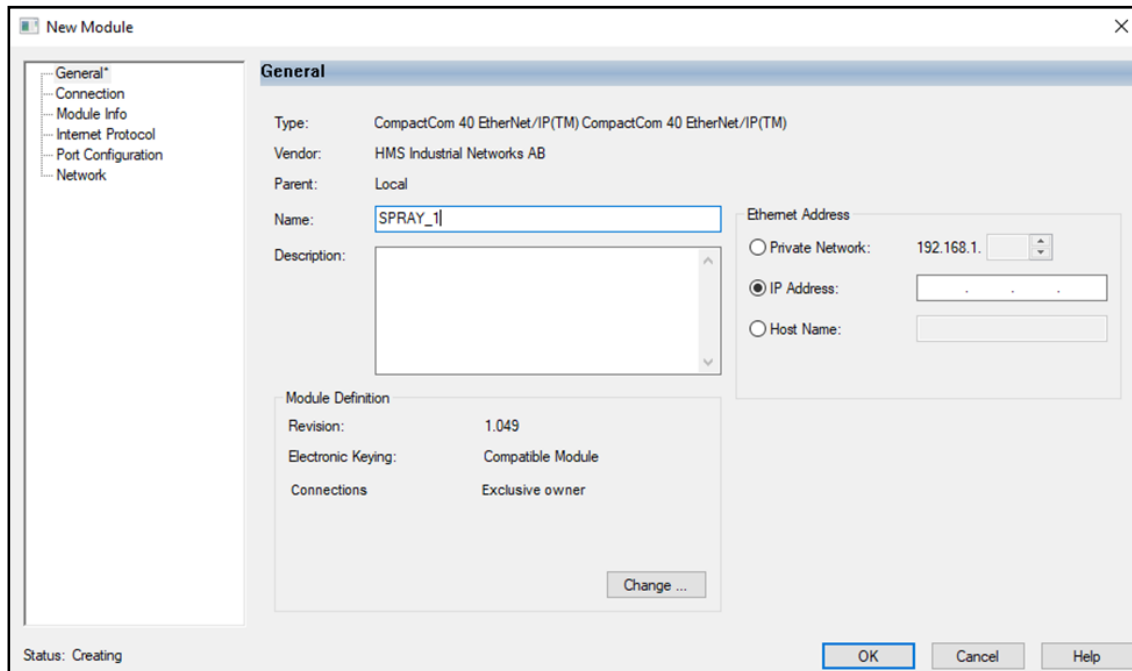

- You will now find your Input and Out arrays. See Read/Write tables either in the manual or on the HMI for address locations.

Name	Value	Force Mask	Style	Data Type	Description
SPRAY_1:I		(...)	(...)	_005A:CompactCom...	
SPRAY_1:I.ConnectionFaulted	0		Decimal	BOOL	
SPRAY_1:I.Data		(...)	(...)	SINT[70]	
SPRAY_1:O		(...)	(...)	_005A:CompactCom...	
SPRAY_1:O.Data		(...)	(...)	Decimal	SINT[98]

End of File Instructions

16.3 ETHERNET IP ADDRESS LIST: READ ADDRESS

The Read Addresses allow you to monitor the 2150 variables such as Nozzle status, Faults, and any additional sensors you have on the system. Below is a list of which tags belong to which arrays. This can also be seen in the Ethernet I/P section on the HMI.

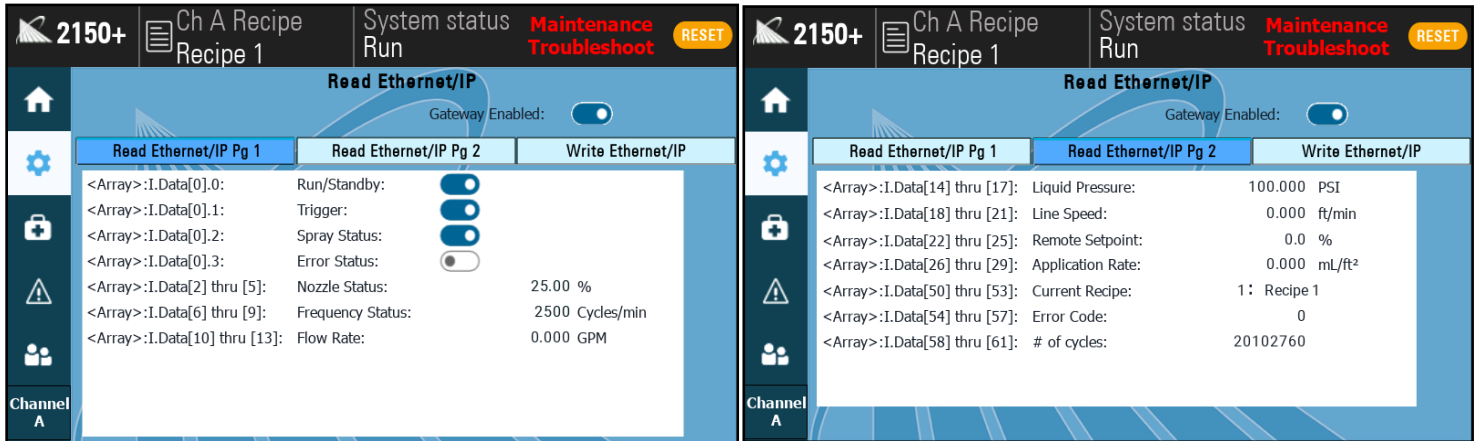

DEFAULT ETHERNET IP PAGE:

READ ADDRESS	FUNCTION	DATA TYPE
<Array>:I Data[0].0	Run/Standby	BOOL
<Array>:I Data[0].1	Trigger	BOOL
<Array>:I Data[0].2	Spray Status	BOOL
<Array>:I Data[0].3	Error Status	BOOL
<Array>:I Data[2] – [5]	Nozzle Status (%)	Integer (Double Word)
<Array>:I Data[6] – [9]	Frequency Status (cycles/min)	Integer (Double Word)
<Array>:I Data[10] – [13]	Flow Rate (GPM)	Integer (Double Word)
<Array>:I Data[14] – [17]	Liquid Pressure (PSI)	Integer (Double Word)
<Array>:I Data[18] – [21]	Line Speed (ft/min)	Integer (Double Word)
<Array>:I Data[22] – [25]	Remote Setpoint (%)	Integer (Double Word)
<Array>:I Data[26] – [29]	Application Rate (mL/ft ²)	Integer (Double Word)
<Array>:I Data[50] – [53]	Current Recipe	Integer (Double Word)
<Array>:I Data[54] – [57]	Error Code	Integer
<Array>:I Data[58] – [61]	# of cycles	Integer

16.4 ETHERNET IP ADDRESS LIST: WRITE ADDRESS

The Write Addresses allow you to control the 2150 via the main controller. This will allow for controls such as starting and stopping the system and changing which recipe is being used. Below is a list of which tags belong to which arrays. This can also be seen in the Ethernet I/P section on the HMI

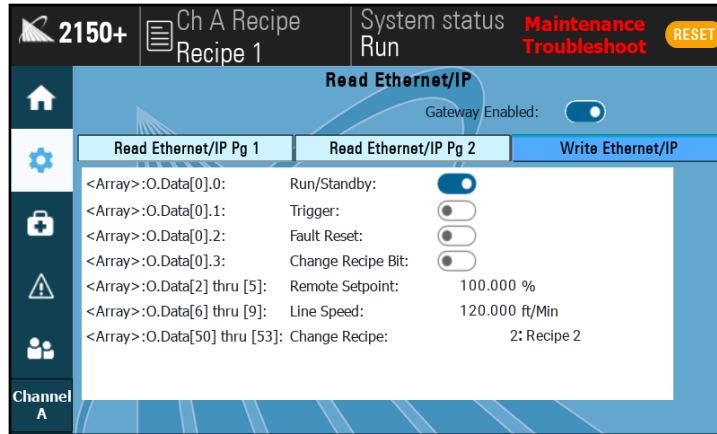

DEFAULT ETHERNET IP PAGE

WRITE ADDRESS	FUNCTION	DATA TYPE
<Array>:O.Data[0].0	Run/Standby	BOOL
<Array>:O.Data[0].1	Trigger	BOOL
<Array>:O.Data[0].2	Fault Reset	BOOL
<Array>:O.Data[0].3	Change Recipe Bit	BOOL
<Array>:O.Data[2] - [5]	Remote Setpoint (%)	REAL
<Array>:O.Data[6] - [9]	Line Speed (ft/min)	REAL
<Array>:O.Data[50] - [53]	Change Recipe	REAL

16.5 BIT NUMBERS, FAULTS, AND THEIR DESCRIPTIONS

The following alarms will be able to be monitored via Ethernet I/P. These will be read as an integer which will need to be parsed into binary. The bit number corresponds to which faults are active. For example, if Bits 2 4 and 10 are 1 and the rest are zero. You have a Hi current alarm, are over temperature on the system, and also are seeing High Pressure.

BIT #	Faults	Descriptions
0	alarmID_AI1,	Liquid pressure sensor wire break detected.
1	alarmID_AI2,	Remote 4-20mA setpoint wire break detected
2	alarmID_HiCurrent,	current on PWM+ exceeded limits.
3	alarmID_LoCurrent,	current on PWM- exceeded limits.
4	alarmID_Overtemp,	Maximum controller operating temperature exceeded.
5	alarmID_HiVoltage,	Input voltage too high.
6	alarmID_LoVoltage,	Input voltage too low.
7	alarmID_Bridge_open,	Open-circuit detected on PWM output.
8	alarmID_Bridge_leak,	Ground fault leak detected on PWM output, check wiring for damage
9	alarmID_Brige_General,	High current draw detected on PWM output
10	alarmID_HiPressure,	Spray pressure is too high.
11	alarmID_LoPressure,	Spray pressure is too low.
12	alarmID_TankEmpty,	Liquid tank is empty.
13	alarmID_Ext1,	Fault 1 triggered remotely.
14	alarmID_Ext2,	Fault 2 triggered remotely.
15	alarmID_AI3,	Flow sensor wire break detected.
16	alarmID_triggerCheck1_TR1,	Unexpected trigger check signal received!
17	alarmID_triggerCheck1_TR2,	Trigger check signal was not verified in time.
18	alarmID_systemIntegrity_blocked,	Flow is lower than expected
19	alarmID_systemIntegrity_worn,	Flow is higher than expected
20	alarmID_digitalOutput,	Digital output error not related to pixel
21	alarmID_digitalOutputBus,	Error related to the AHSB External digital output bus
22	alarmID_pixelDigitalOutput,	Digital output error related to pixel
23	alarmID_24Voutput,	
24	alarmID_Count	

SPARE PARTS—REPLACEMENTS

Repair Kits	
2150+ Single Channel 48V: 2300, HMI, Switch Assembly, Fuses, Fan, Comm Cable, Fan	060TS06210035W0
2150+ Dual Channel 48V: 2300's (CHA/CHB), HMI, Switch Assembly, Fuses, Fan, Comm Cable, Fan	060TS06210036W0
2150+ High Capacity 48V: 2300's (CHA/Slave), HMI, Switch Assembly, Fuses, Fan, Comm Cable, Fan	060TS06210037W0
24V Single Channel Parts	
Series 2300 Spray Controller, 24V version, Ethernet/IP with Modbus 1 file for Channel A	CP-CTTMT232I-00_CA01
Cover plate kit, for channel two, 2150+ control panel, with sealing gasket and hardware.	CP-ENECT2150-01_CB01
Labels, 2150+ underside, Single Channel versions, Adhesive backed, Black/White..	LAPCNS000029-01_AC07
Cap, M12(f) Connector, for covering M12 male threads	JC002774398ND
Cap, cap threads (male) into female pico thread (M8) receptacles, black nylon	WR00PSGMCC
24V Dual Channel Parts	
Series 2300 Spray Controller, 24V version, Ethernet/IP with Modbus 1 file for Channel A	CP-CTTMT232I-00_CA01
Series 2300 Spray Controller, 24V version, Ethernet/IP with Modbus 2 file for Channel B	CP-CTTMT232I-00_CA02
48V Single Channel Parts	
Power supply, 48 to 56 VDC, rated Output Current of 12 to 10.3 Amps continuous, rated Output Power of 480 Watts continuous, 100 to 240 VAC Single Phase	PY00CP2048V10A
Cap, M12(f) Connector, for covering M12 male threads	JC002774398ND
Cap, cap threads (male) into female pico thread (M8) receptacles, black nylon	WR00PSGMCC
48V Dual Channel Parts	
Series 2300 Spray Controller, 48V version, Ethernet/IP with Modbus 2 file for Channel B	CP-CTTMT234I- 00_CA02
Power supply, 48 to 56 VDC, rated Output Current of 12 to 10.3 Amps continuous, rated Output Power of 480 Watts continuous, 100 to 240 VAC Single Phase	PY00CP2048V10A
48V High Capacity Parts	
Power supply, 48 to 56 VDC, rated Output Current of 12 to 10.3 Amps continuous, rated Output Power of 480 Watts continuous, 100 to 240 VAC Single Phase	PY00CP2048V10A
Cap, M12(f) Connector, for covering M12 male threads.	JC002774398ND
Cap, cap threads (male) into female pico thread (M8) receptacles, black nylon	WR00PSGMCC



Accessory Kits	
Photoelectric Object Sensor: Object Sensor Kit, Trig, 5 m cord length, M12 3 pin (F)	040TS04000014W0
Proximity sensor: Detects all metals 10mm max. sense dist., 24vdc, NPN outputs N.O./N.C., shielded, IP67, 5m cable wired	040TS04000118W0
Thru-Beam Sensor: Trig, 5 m cord length, connector—M12 3 pin female, IP67/IP69K rating, NPN output	040TS04000028W0
Laser Sensor (Short): mounting bracket, accurate short sensing distances of 25 to 90 mm, std. detectable deviation 1.5-3.0mm, NPN/PNP open collector, 24Vdc, M12 3 pin male connection, 5m cable	040TS04000135W0
Laser Sensor (Long): 5m cable, and mounting bracket, 24Vdc, NPN. IP68/ IP69K.	040TS04000087W0
Level Switch Cable Kit: Main/T. int., M12 (M) x 2 M12 (F), 1 m whip cord length. Cable Kit, Level Switch to Alarm Output Cable, 24VDC	040TS04000064W0
Fault Output Signal Kit: Cable Kit, SCS Series Alarm Output	040TS04000054W0
Accessory Cables	
Electric Nozzle Cable: Main, 3 m cord length, Mini DIN, M12 3 pin male	LE00M12MMDIN3MU
PulsaJet Nozzle Cable: Main, 3m cord length, M8 3 pin female, M12 3 pin male	LEXXSD3M83F030P
Extension Cable: Main/Trig, 5 m cord length, M12 4 pin (F/M)	LEXXSD4FD4M005P
Trigger Cable: Trig, 5 m cord length, flying leads, M12 4 pin female	LE00M12F5M
Trigger Interlock: T. int. 5 m cord length, flying leads, M8 4 pin female	LE00M8F5M
Level Sensor Input: Cable, M8 Female, 4 pole, bare leads, 5 meter	LE00M8F5M
Input Signal: M8 4 pin male, 4-20mA, 5 m cord length, flying leads	LE00M8M5M
Level Switch Cable Adapter: Splitter, wye, M12, 4 pole, trunk = male M12 1m whip, 2 branches x M12 female coupling nuts, TPU, parallel wiring	LE00M12WYE1M
Fault Output Signal Adapter: Splitter, wye, M12, 4 pole, trunk = male M12 1m whip, 2 branches x M12 female coupling nuts, TPU, parallel wiring.	LE00M12WYE1M
Level Switch Cable: Main, M12 Male, 4 pin, 4 wire, bare leads, 5 meter	LE00M12M5M
Fault Output Signal Cable: M12 Male, 4 pin, 4 wire, bare leads, 5 meter.	LE00M12M5M
Accessory Switches	
Hand Trigger Pendant: hand trigger pendant, selector switch and button, M12 female 4 pole, 5 meter cable	SW001550M12HT
Foot Switch: Momentary on switch, M12 (F) connector, 5 m cable length	040TS04000130W0

© 2024 All rights reserved. Printed in the U.S.A.

Under copyright laws, this manual may not be reproduced in any form, in whole, or in part, without prior written permission from Spraying Systems Co[®]. This revision supersedes all previous revisions. Every effort has been made to ensure that the information in this manual is accurate at the time of printing.

However, Spraying Systems Co. assumes no liability for errors or omissions and reserves the right to make changes without notice to any products described herein to improve reliability, function, or design. Other company and product names may be trademarks of their respective companies.

Warranty is one (1) year on non-wear parts from ship date. Wear items are covered for manufacturing defect only for a period of one (1) year. Wear items include, but may not be limited to the liquid pump and liquid regulator, if equipped. Seller warrants that its products will conform to and perform in accordance with the products' specifications.

Seller warrants that the products do not infringe upon any copyright, patent, or trademark.

THE FOREGOING WARRANTIES ARE IN LIEU OF ALL OTHER WARRANTIES, EXPRESS OR IMPLIED, INCLUDING, BUT NOT LIMITED TO, THOSE CONCERNING MERCHANTABILITY AND FITNESS FOR A PARTICULAR PURPOSE.



Spraying Systems Co.[®]
Experts in Spray Technology

North Avenue and Schmale Road, P.O. Box 7900, Wheaton, IL 60187 - 7901

Tel: 1.800.95.SPRAY Intl. Tel: 1.630.665.5000

Fax: 1.888.95.SPRAY Intl. Fax: 1.630.260.0842

www.spray.com



ML002150PLUS Rev. 5 9/2024

© Spraying Systems Co. 2024