

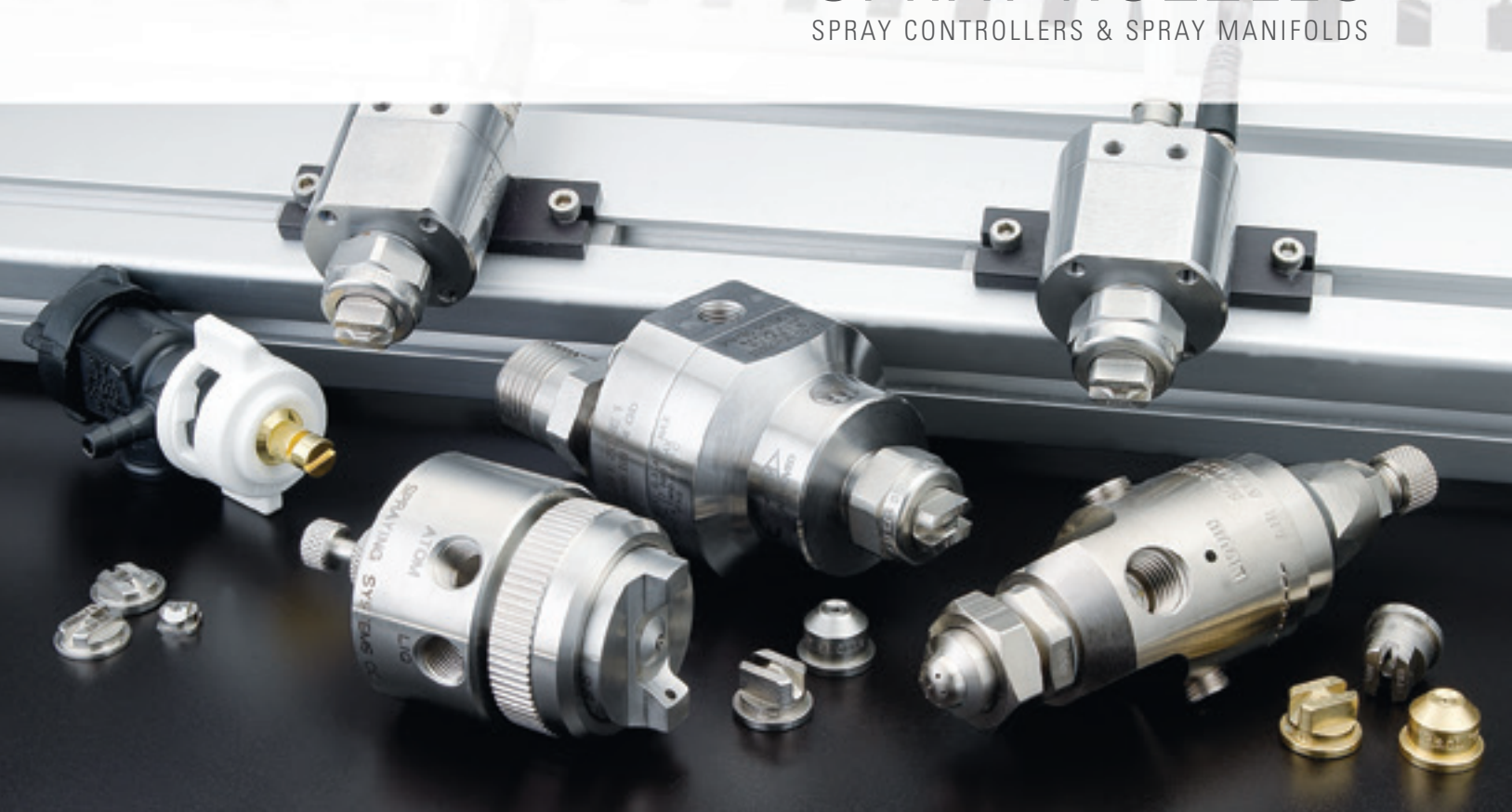

**Spraying Systems Co.®**  
Experts in Spray Technology

# AIR ATOMIZING & AUTOMATIC SPRAY NOZZLES

SPRAY CONTROLLERS & SPRAY MANIFOLDS



[spray.com](http://spray.com)



# THANK YOU FOR YOUR INTEREST IN OUR SPRAY PRODUCTS

WE'RE LOOKING FORWARD TO HELPING YOU OPTIMIZE YOUR OPERATIONS INVOLVING SPRAY TECHNOLOGY. HERE ARE JUST A FEW WAYS WE CAN ASSIST:

- You'll find the most extensive line of high-quality automatic and air atomizing nozzles, spray controllers and spray manifolds in this catalog. However, if you don't find exactly what you need, be sure to contact us. Our flexible manufacturing capabilities allow us to make products in additional sizes and materials quickly and efficiently. Special designs are also possible. Just tell us what you need
- Need a different type of spray solution? Or a spray product for a specific application? Visit [spray.com](http://spray.com) to find additional information on these products:
- On-site evaluations, spray optimization programs, lunch and learn sessions and nozzle maintenance workshops are just a few of the many services we provide. It's easy to take advantage of these programs – just contact your local representative. You'll find a spray expert nearby – we have hundreds of technical sales and service people in more than 90 sales offices around the world
- Need a device to deliver fluid to your nozzles? Talk to us about spray manifolds, headers, lances, injectors and more

- ☞ – Hydraulic spray products including FullJet®, VeeJet®, WhirlJet®, SpiralJet® nozzles and more
- ☞ – AutoJet® spray controllers and automated spray systems
- ☞ – Hand held GunJet® spray guns
- ☞ – WindJet® nozzles and air knife packages
- ☞ – TankJet® tank cleaning products
- ☞ – SprayDry® nozzles
- ☞ – Pulp and paper spray products
- ☞ – Steel industry spray products

## ☞ SUPERIOR SPRAY. SERIOUS RESULTS.











Visit [spray.com/results](http://spray.com/results) to see how we've helped others increase throughput, reduce water and chemical use, improve worker safety and more. This library of case studies includes details on how quickly customers recouped their investment in new spray equipment.

These are just a few of the ways we can help you get the results you need in your coating, cleaning, humidifying, lubricating, moisturizing and other operations using spray technology. You will learn about other ways we can assist in the pages that follow. Please be sure to visit [spray.com](http://spray.com) or contact us whenever you need assistance – we're here to serve you.

**Thank you – we value your business!**



## TABLE OF CONTENTS

	What You Can Expect	2
	Spray System Optimization	8
	How to Order and Customer Service	10
	Technical Reference	A1
	Air Atomizing Spray Nozzles	B1
	Automatic Spray Nozzles	C1
	Spray Tips and Performance Data	D1
	Fogging and Humidification	E1
	Spray Manifolds	F1
	Accessories	G1
	Index	i-1





# THE PRODUCTS YOU NEED AND PERFORMANCE YOU CAN COUNT ON

You'll find thousands of automatic and air atomizing nozzles, spray controllers, and spray manifolds in this catalog but you can also visit [spray.com](http://spray.com) to see thousands of other spray products. Featured products include hydraulic spray nozzles, handheld spray guns, tank cleaning equipment, air nozzles and nozzles for specialized operations like descaling, trim squirt, spray drying, fire protection and more. We offer the widest range of spray products available, so you're sure to find a solution that delivers the performance you need.

## PRECISE, DEPENDABLE PRODUCT QUALITY

Your satisfaction is important to us. Our products are manufactured to exacting standards to deliver the promised performance each and every time you order. We are ISO 9001:2008 and 14001:2004 certified. Products ship only after undergoing our rigorous quality control and testing programs. If you have any concerns about the quality of any of our products, contact us immediately. We will address your issues and take corrective action as needed.

## PRODUCTS WHEN YOU NEED THEM

Most of our spray nozzles are readily available and will be shipped within days of your order. If you need expedited service, let us know. Our ten manufacturing locations are strategically located around the world to help ensure quick and cost-effective product delivery.

## SPECIAL REQUIREMENTS? TELL US WHAT YOU NEED.

If one of our standard products isn't quite right for your equipment, just let us know. Customization can range from simple changes in materials to specially-designed nozzles to meet exacting performance requirements.

### We work with hundreds of OEMs and provide services like these:

- Special nozzle designs
- Private labeling with unique part numbers
- Special packaging
- Customized maintenance and operating instructions





# THE SERVICES YOU NEED, WHEN AND WHERE YOU NEED THEM

## OUR SOLE FOCUS ON SPRAY TECHNOLOGY ENSURES RESULTS IN YOUR OPERATIONS

Since spray technology is all we do, we have a level of expertise that can't be matched. Our sales engineers are factory-trained and only sell our spray products. Need to increase throughput in a coating operation? Eliminate waste or lower scrap? Cool products more quickly? Suppress dust? Minimize water and chemical use in cleaning operations? Just give us a call. With sales offices on six continents and more than 90 sales offices, we are in your area and ready to help.

### WHAT CUSTOMERS SAY ABOUT OUR SERVICE

"We are very pleased with Spraying Systems Co. Wish all vendors were as good."

"Very pleased – awesome is the best way to describe Spraying Systems Co. service."

"A+ on service. Sales engineer responded quickly and visited my facility to review various product options for my application."

"Rep always provides prompt answers. Knows the full product line inside and out."

"I get more technical support from Spraying Systems Co. than any other vendor."

"The local rep. came right out – didn't even know the size of the project at the time."

"Spraying Systems Co. provides solutions – not just parts."

"More knowledgeable than any other equipment company we work with."

"We get the products we need, when we need them. Each and every time we order."





# SPRAY CONTROL OPTIMIZES SPRAY NOZZLE PERFORMANCE

## SPRAY CONTROL

Spray nozzles can only perform properly if the entire spray system is operating efficiently. That's why we offer a wide range of AutoJet® spray controllers. Choose from basic automatic control, monitoring of spray variables or automatic adjustments of spray variables based on what is happening in your process. Adding a spray controller can help:

- Increase production through automation and enable operation at variable line speeds
- Reduce labor costs by eliminating manual operation, system monitoring and changeover of nozzles between batches
- Lower operating costs by eliminating overspray and waste through precision spraying
- Improve worker safety by minimizing exposure to harmful chemicals

Application-specific systems are also part of our offering for more demanding spray operations.

## TURNKEY SYSTEM OPTIONS

- AccuCoat® Heated Spray Systems for viscous coatings
- AutoJet® Antimicrobial and Mold Inhibitor Spray Systems for food safety applications
- PanelSpray® System for engineered wood products
- AutoJet® Tissue and Web Lamination Spray System for tissue and other hygienic products
- AutoJet® Gas Cooling System for pollution control

Additional options include systems for dust suppression, NOx control and humidification. Check with your local sales office; system availability may vary by region.

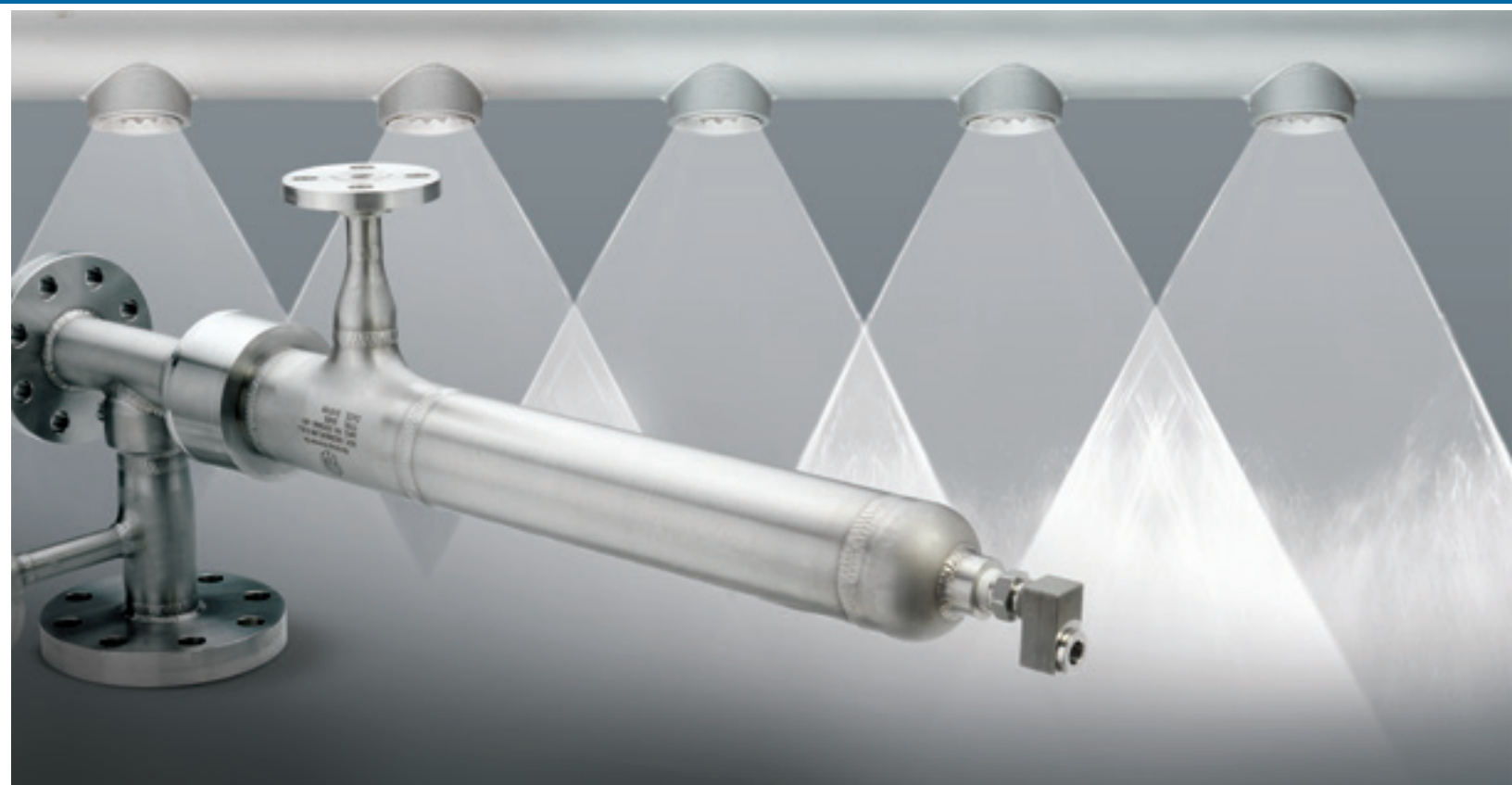

## SPRAY MANIFOLDS, HEADERS AND INJECTORS

The equipment that supplies fluid to spray nozzles can have a big impact on performance. If the fluid flow isn't adequate or the fluid delivery device isn't suitable for the operating environment, performance may be compromised. Unlike feed devices built by fabricators or in-house staff, our spray manifolds, headers, showers, injectors, lances and quills are designed to optimize the performance of our spray nozzles and streamline your operations.

You can specify the length, number of nozzles, nozzle spacing and connection type for most of our manifolds and headers. Spray injectors can also be customized. You can specify nozzle type, nozzle placement, materials, coatings and specialized testing services.

The next time you order spray nozzles, take a moment to consider your fluid delivery equipment. Talk to your local sales engineer about ways to maximize performance and service life and simplify maintenance.

### PRODUCT OPTIONS INCLUDE:

- Basic spray nozzle manifolds with a C-channel to facilitate spray nozzle set-up and adjustment
- Pipe-in-pipe spray manifolds with nozzles mounted inside a slotted pipe for protection against build-up and damage
- Modular spray manifolds with easy-to-access tubing and fittings to simplify set-up and cleaning
- Heated spray manifolds for use with viscous solutions
- Sanitary spray manifolds to ensure food safety
- Built-to-order spray manifolds
- Automatic brush showers that keep nozzles clean without process interruption or maintenance downtime
- Built-to-order spray injectors for use in demanding environments such as refineries, power plants and chemical production
- Spray quills and lances for use in environments where spray performance is less critical



# PERFORMANCE VALIDATION BEFORE YOU BUY

## TESTING SERVICES HELP ENSURE PRECISION SPRAY PERFORMANCE

In new spray applications or applications where spray performance is critical, it is important to understand how factors like these affect performance:

- Operating conditions such as pressure, temperature and variable line speeds
- The liquid being sprayed
- The placement and position of nozzles in relation to the target

In many cases, experience and theoretical calculations can provide an indication of actual spray performance. However, testing in our spray labs determines actual performance and can eliminate costly specification mistakes or quality problems after installation. During testing, we can adjust operating conditions and/or test different nozzles until we find the exact spray performance required in your application.

### Common tests include:

- Spray characterization
- Spray angle
- Drop size distribution
- Evaporation rate
- Spray impact
- Residence time
- Spray pattern
- Dwell time
- Spray coverage

### A LOOK INSIDE OUR LABS

Evaluating sprays requires very specialized equipment. In fact, some of our equipment was designed by our spray engineers and is used only in our facilities. Our test equipment includes:

- Spray patternators to measure spray distribution
- Impact testers to determine impact throughout a spray
- Laser diffraction and Phase Doppler particle size analyzers to measure drop size and spray velocity
- Laser sheet imaging analyzers to evaluate spray shape and distribution
- Wind tunnel to determine the effects of air currents and gas flows on sprays





**ADVANCED MODELING SERVICES AND MANUFACTURING CAPABILITIES FOR COMPLEX AND DEMANDING APPLICATIONS**

It is not feasible to replicate operating conditions for every application. Gas cooling, chemical injection, spray drying and tablet coating are just a few applications where we cannot spray some liquids for safety reasons or procure comparable process equipment. Yet, in these applications, understanding spray performance is often critical to process efficiency, product quality, equipment longevity and even worker safety. That’s when we use sophisticated modeling tools to predict spray performance.

- Computational Fluid Dynamics (CFD) models illustrate flow patterns, velocity, temperature, gas/liquid distributions, droplet trajectories, internal system pressure and more in scrubbers, towers, ducts and dryers. Our models use data we’ve collected in our spray labs to reduce the error factor and precisely predict spray performance
- Fluid Structure Interaction (FSI) examines the interaction between fluid dynamics and structural integrity. This enables us to determine the materials required to withstand mechanical stresses such as load, pressure, turbulence, corrosion and more

Demanding applications often require the use of special materials and compliance with various manufacturing codes and testing standards. We can produce nozzles, quills, injectors and headers to exacting standards and conduct a wide range of tests to validate construction.

**MANUFACTURING AND TESTING CAPABILITIES**

**Manufacturing:**

- ASME, Boiler and Pressure Vessel Code
- ASME B31.1 Power Piping Code
- ASME B31.3 Process Piping Code
- Welding to ASME B&PV Code Section IX
- cGMP
- Canadian Registration Number requirements

**Testing in accordance with ANSI®, ASTM® standards:**

- Ultrasonic
- Radiographic
- Liquid penetrant
- Hardness
- Hydrostatic
- Magnetic particle examination
- Positive material identification

See Trademark Registration and Ownership, page i-1.

Learn more about our testing and modeling services at [sprayanalysis.com](http://sprayanalysis.com)

# HOW YOU CAN BENEFIT FROM SPRAY SYSTEM OPTIMIZATION

### WAYS TO LEARN MORE



#### EXPERT ADVICE AT YOUR PLANT

**No-charge spray system evaluation** – Your local sales engineer will inspect your current spray operations and provide suggestions on how to improve efficiency. Evaluations can focus on a specific area such as reducing water or compressed air use, tank cleaning, automation opportunities and more.

#### Complimentary Lunch and Learn workshops

– Select a topic, choose a date and invite your colleagues. We'll provide lunch and an informative 60-minute session. Popular topics include *Spray Nozzle Basics*, *Understanding Drop Size* and *How to Reduce Use of Costly Chemicals*.

#### Spray demos and proof-of-concept trials at your facility

– Your local sales engineer will conduct demos and tests on-site so you can see how a product will work in your environment. When operating conditions don't allow an on-site demo or test, other arrangements can be made.

### TESTS AND DEMONSTRATIONS AVAILABLE AT REGIONAL SPRAY TECHNOLOGY CENTERS

Throughout North America, we have several Spray Technology Centers. These facilities are equipped to conduct proof-of-concept tests and technology demonstrations. Seminars including live demonstrations on various topics are also conducted throughout the year. Schedules vary by region so contact your local sales engineer for information.



#### SUSTAINABILITY ASSESSMENT PROGRAM

Let our team of experts help you identify actionable ways to:

- Reduce water, chemical and energy use
- Reduce scrap and waste
- Improve worker safety

We will visit your plant and evaluate your essential spraying applications and uncover ways to help your operations become more efficient, productive, sustainable and safe. Visit [spray.com/sustainability-assessment](https://spray.com/sustainability-assessment) for more information.





## EDUCATIONAL RESOURCES

### Video demonstrations and tutorials on [spray.com](http://spray.com) and [YouTube.com/sprayingystems](https://www.youtube.com/sprayingystems)

Explore our video library and learn about new spray products and techniques; best practices in maintenance procedures; what to look for in a spray pattern and more.

### Technical guides and white papers on [spray.com](http://spray.com)

- *Optimizing Your Spray System*, Technical Manual 410
- White papers address a wide range of topics. Here are a few examples:
  - Less Time & Lower Costs
  - Optimizing Spray Performance
  - Strategies to Reduce Your Water & Chemical Footprint
  - Optimizing the Efficacy of Antimicrobial Application on Meat & Poultry

### Case studies on [spray.com](http://spray.com)

More than 75 case studies demonstrate the benefits other processors have experienced through spray optimization. See [spray.com/results](http://spray.com/results).

### Catalogs on [spray.com](http://spray.com)

- Hydraulic Automatic Nozzles
- Automatic and Air Atomizing Nozzles, Spray Controllers and Spray Manifolds
- TankJet® Tank Cleaning Products
- WindJet® Air Products
- SprayDry® Nozzles
- Spray Technology for Steelmaking
- Spray Technology for Pulp and Papermaking
- Car Wash Products
- GunJet® Handheld Spray Guns
- Plus dozens of market- and product-specific technical bulletins





# ORDERING PRODUCTS

For assistance with product selection and ordering, please contact your local sales office. Sales engineers are available and will help you determine which products best meet your application requirements. Call **1.800.95.SPRAY** in North America. If you are outside of North America, call **1.630.665.5000** or visit **spray.com** to find information for the sales office in your area. For your convenience, there are multiple ways to place an order: phone, fax and online.

### In North America

Phone: 1.800.95.SPRAY | Fax: 1.888.95.SPRAY

### Outside North America

Phone: 1.630.665.5000 | Fax: 1.630.260.0842

**Online ordering is also available. Visit [spray.com/sprayfinder](https://www.spray.com/sprayfinder).** You'll find helpful selection tools, detailed product specs and 3D CAD models for our full product line and live chat for immediate assistance.

## FINDING PRODUCTS

- Consult the Product Index on **page i-3** if you know the name of the product
- Consult the Part Number Index on **page i-5** if you have the part number. Part numbers are shown alphanumerically on **page i-6**
- Selection assistance is available by calling your local sales office







# TECHNICAL REFERENCE TABLE OF CONTENTS

Basic Nozzle Characteristics	A2
Capacity and Specific Gravity	A3
Spray Performance Considerations	A4
Pump Selection Guidelines	A5
Spray Drop Size, Drop Size Terminology, Operating Pressure and Nozzle Materials	A6
Nozzle Wear, Viscosity, Temperature and Surface Tension	A7
Pressure Drop	A8
Maintenance Tips	A10
Weights, Measurements and Formulas	A11
General Safety Instructions	A12

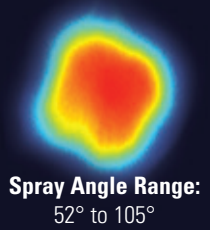

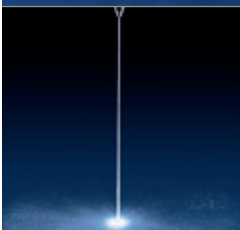
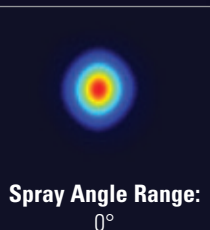
Spray nozzles are precision components designed to yield very specific performance under specific conditions. To help you determine the best nozzle type for your application, the following chart summarizes the performance that each nozzle type is designed to deliver. Visit [youtube.com/sprayingystems](https://www.youtube.com/sprayingystems) for video demonstrations of spray patterns.

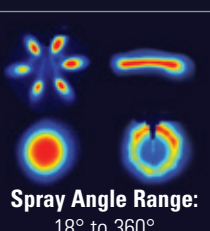
The spray pattern images on the right were acquired in our spray laboratories using Laser Sheet Imaging (LSI). LSI images are collected by passing a laser sheet through a cross-section of the spray plume and imaging with a light-filtered camera. The distributions are directly proportional to the surface area distribution of the sprayed material (red: high; blue: low; black: zero). Volume distributions typically are similar to surface area distributions for these nozzles, depending on the local drop size distributions.

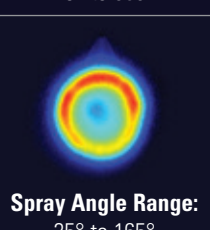
	FULL CONE NOZZLES	Typical applications:	LASER SHEET IMAGE
	<p><b>FULL CONE (SQUARE SPRAY) NOZZLES</b></p> <ul style="list-style-type: none"> <li>• Uses a unique internal vane to produce a solid cone-shaped spray with square impact area</li> <li>• Spray pattern is uniform across entire spray area</li> <li>• Spray pattern consists of medium- to large-sized drops</li> </ul>	<p><b>Typical applications:</b></p> <ul style="list-style-type: none"> <li>• Chemical injection</li> <li>• Dust suppression</li> <li>• Fire protection</li> <li>• Metal cooling</li> <li>• Washing/rinsing</li> </ul>	 <p><b>Spray Angle Range:</b> 52° to 105°</p>
	<p><b>FLAT SPRAY (TAPERED) NOZZLES</b></p> <ul style="list-style-type: none"> <li>• Produces a tapered-edge flat spray pattern</li> <li>• Used on spray headers to provide uniform coverage as a result of overlapping distributions</li> </ul>	<p><b>Typical applications:</b></p> <ul style="list-style-type: none"> <li>• Air/gas washing</li> <li>• Cooling and quenching</li> <li>• Dust control</li> <li>• Fire suppression</li> </ul>	 <p><b>Spray Angle Range:</b> 15° to 110°</p>
	<p><b>SOLID STREAM NOZZLES</b></p> <ul style="list-style-type: none"> <li>• Produces a solid stream spray with the highest impact per unit area</li> </ul>	<p><b>Typical applications:</b></p> <ul style="list-style-type: none"> <li>• Coating</li> <li>• Lubricating</li> <li>• Glazing</li> </ul>	 <p><b>Spray Angle Range:</b> 0°</p>
	<p><b>AIR ATOMIZING AND AIR ASSISTED NOZZLES</b></p> <ul style="list-style-type: none"> <li>• Produces a variety of cone and flat spray patterns through atomization of liquid by compressed air</li> <li>• Internal mix impingement atomization forms very fine drops</li> </ul>	<p><b>Typical applications:</b></p> <ul style="list-style-type: none"> <li>• Marking</li> <li>• Laminar flow application</li> </ul>	 <p><b>Spray Angle Range:</b> 18° to 360°</p>
	<p><b>ATOMIZING (HYDRAULIC, FINE MIST) NOZZLES</b></p> <ul style="list-style-type: none"> <li>• Produces a finely atomized, low capacity spray in a hollow cone pattern without use of compressed air</li> </ul>	<p><b>Typical applications:</b></p> <ul style="list-style-type: none"> <li>• Coating</li> <li>• Evaporative cooling</li> <li>• Humidification</li> <li>• Moisturizing</li> </ul>	 <p><b>Spray Angle Range:</b> 35° to 165°</p>

**CAPACITY – FLUID CAPACITY FOR HYDRAULIC NOZZLES VARIES WITH SPRAYING PRESSURE**

The relationship of pressure and flow with a given orifice is:

$$\frac{Q_1}{Q_2} \sim \frac{(P_1)^n}{(P_2)^n}$$

**Q** = Flow Rate (in gpm or lpm)  
**P** = Liquid pressure (in psi or bar)  
**n** = Flow exponent

To approximate any unknown flow or pressure, use this formula when the other variables are known. The "n" exponent is used to approximate the ratio of pressure to flow based on the type of spray pattern.

**Example:**

To determine the flow rate of water for a 1/4G-10 standard full cone nozzle at 150 psi (10 bar), consult the performance charts in this catalog.

You will find that:

- The spray angle is 65°
- Flow (Q<sub>1</sub>) at 40 psi = 1.9 gpm
- Pressure (P<sub>1</sub>) = 40 psi
- Pressure (P<sub>2</sub>) = 150 psi

Solving for Q<sub>2</sub> = 3.5 gpm

$$Q_2 = \frac{Q_1}{(P_1/P_2)^n} = \frac{1.9 \text{ gpm}}{(40/150)^{.46}}$$

- The spray angle is 65°
- Flow (Q<sub>1</sub>) at 3 bar = 7.5 lpm
- Pressure (P<sub>1</sub>) = 3 bar
- Pressure (P<sub>2</sub>) = 10 bar

Solving for Q<sub>2</sub> = 13 lpm

$$Q_2 = \frac{Q_1}{(P_1/P_2)^n} = \frac{7.5 \text{ lpm}}{(3/10)^{.46}}$$

**FLOW EXPONENT FOR SPECIFIC HYDRAULIC NOZZLE TYPES**

Nozzle Type	Exponent "n"
Flat Spray Nozzles – All	.50
Full cone Nozzles – Vaneless, 15° and 30° Series	
Hollow Cone Nozzles – All	
Solid Stream Nozzles – All	
Full Cone Nozzles – Standard and Square	.46
Full Cone Nozzles – Wide Spray and Wide Square Spray	.44

Visit [spray.com/sprayware](http://spray.com/sprayware) for online flow rate and spray coverage calculators.

**SPECIFIC GRAVITY**

All capacity tabulations in this catalog are based on water. Since the specific gravity of a liquid affects its flow rate, tabulated catalog capacities must be multiplied by the conversion factor that applies to the specific gravity of the liquid being sprayed as explained below.

Specific gravity is the ratio of the density of a fluid compared to the density of water. The specific gravity of water is defined as 1. When spraying fluids other than water, specific gravity must be considered in the flow calculations.

$$Q_2 = Q_1(\text{water}) \times \frac{1}{\sqrt{SG}}$$

**Using the previous example:**

- Fluid sprayed is heavier than water and has a specific gravity of 1.4
- Flow of water at 150 psi = 3.5 gpm
- Heavy fluid (Q<sub>2</sub>) = Q<sub>1</sub>(water)\*1/√1.4

$$Q_2 = \frac{3.5 \text{ gpm} * 1}{\sqrt{1.4}} = 2.95 \text{ gpm}$$

- Fluid sprayed is heavier than water and has a specific gravity of 1.4
- Flow of water at 10 bar = 13 lpm
- Heavy fluid (Q<sub>2</sub>) = Q<sub>1</sub>(water)\*1/√1.4

$$Q_2 = \frac{13 \text{ lpm} * 1}{\sqrt{1.4}} = 11 \text{ lpm}$$

**SPECIFIC GRAVITY VERSUS CONVERSION FACTOR**

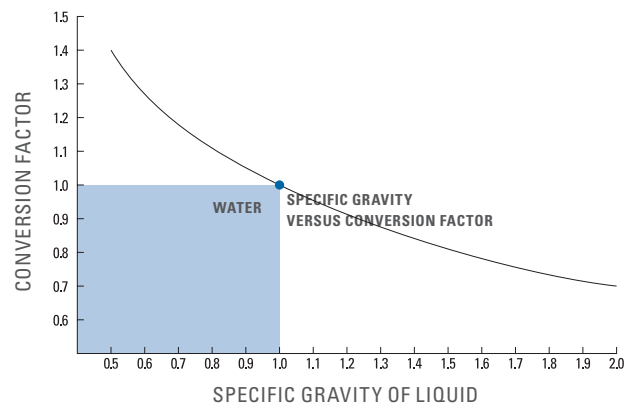

KEY: Conversion factor multiplied by the capacity of the nozzle when spraying water gives the capacity of the nozzle when spraying a liquid with a specific gravity corresponding to the conversion factor. This conversion factor accounts only for the effect of specific gravity on capacity and does not account for other factors affecting capacity.

SPRAY ANGLE AND COVERAGE

Tabulated spray angles indicate approximate spray coverage based on spray or distribution of water. In actual spraying, the effective spray angle varies with spray distance. Liquids more viscous than water form relatively smaller spray angles (or even a solid stream), depending upon viscosity, nozzle capacity and spraying pressure. Liquids with surface tensions lower than water will produce relatively wider spray angles than those listed for water. This table lists the theoretical coverage of spray patterns as calculated from the included spray angle of the spray and the distance from the nozzle orifice. Values are based on the assumption that the spray angle remains the same throughout the entire spray distance. In actual practice, the tabulated spray angle does not hold for long spray distances. If the spray coverage requirement is critical, request data sheets for specific spray coverage data.

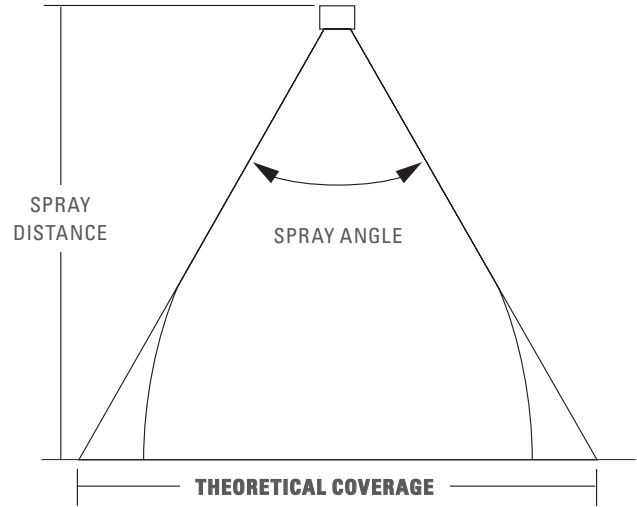

**Example:** A spray nozzle with an angle of 65° spraying 15" (39 cm) from the target provides 19.2" (48.8 cm) of coverage

THEORETICAL SPRAY COVERAGE AT VARIOUS DISTANCES IN INCHES (CM) FROM NOZZLE ORIFICE

Spray Angle	2 in.	5 cm	4 in.	10 cm	6 in.	15 cm	8 in.	20 cm	10 in.	25 cm	12 in.	30 cm	15 in.	40 cm	18 in.	50 cm	24 in.	60 cm
5°	.2	.4	.4	.9	.5	1.3	.7	1.8	.9	2.2	1.1	2.6	1.3	3.5	1.6	4.4	2.1	5.2
10°	.4	.9	.7	1.8	1.1	2.6	1.4	3.5	1.8	4.4	2.1	5.3	2.6	7.0	3.1	8.8	4.2	10.5
15°	.5	1.3	1.1	2.6	1.6	4.0	2.1	5.3	2.6	6.6	3.2	7.9	3.9	10.5	4.7	13.2	6.3	15.8
20°	.7	1.8	1.4	3.5	2.1	5.3	2.8	7.1	3.5	8.8	4.2	10.6	5.3	14.1	6.4	17.6	8.5	21.2
25°	.9	2.2	1.8	4.4	2.7	6.7	3.5	8.9	4.4	11.1	5.3	13.3	6.6	17.7	8.0	22.2	10.6	26.6
30°	1.1	2.7	2.1	5.4	3.2	8.0	4.3	10.7	5.4	13.4	6.4	16.1	8.1	21.4	9.7	26.8	12.8	32.2
35°	1.3	3.2	2.5	6.3	3.8	9.5	5.0	12.6	6.3	15.8	7.6	18.9	9.5	25.2	11.3	31.5	15.5	37.8
40°	1.5	3.6	2.9	7.3	4.4	10.9	5.8	14.6	7.3	18.2	8.7	21.8	10.9	29.1	13.1	36.4	17.5	43.7
45°	1.7	4.1	3.3	8.3	5.0	12.4	6.6	16.6	8.3	20.7	9.9	24.9	12.4	33.1	14.9	41.4	19.9	49.7
50°	1.9	4.7	3.7	9.3	5.6	14.0	7.5	18.7	9.3	23.3	11.2	28.0	14.0	37.3	16.8	46.6	22.4	56.0
55°	2.1	5.2	4.2	10.4	6.3	15.6	8.3	20.8	10.3	26.0	12.5	31.2	15.6	41.7	18.7	52.1	25.0	62.5
60°	2.3	5.8	4.6	11.6	6.9	17.3	9.2	23.1	11.5	28.9	13.8	34.6	17.3	46.2	20.6	57.7	27.7	69.3
65°	2.5	6.4	5.1	12.7	7.6	19.1	10.2	25.5	12.7	31.9	15.3	38.2	19.2	51.0	22.9	63.7	30.5	76.5
70°	2.8	7.0	5.6	14.0	8.4	21.0	11.2	28.0	14.0	35.0	16.8	42.0	21.0	56.0	25.2	70.0	33.6	84.0
75°	3.1	7.7	6.1	15.4	9.2	23.0	12.3	30.7	15.3	38.4	18.4	46.0	23.0	61.4	27.6	76.7	36.8	92.1
80°	3.4	8.4	6.7	16.8	10.1	25.2	13.4	33.6	16.8	42.0	20.2	50.4	25.2	67.1	30.3	83.9	40.3	101
85°	3.7	9.2	7.3	18.3	11.0	27.5	14.7	36.7	18.3	45.8	22.0	55.0	27.5	73.3	33.0	91.6	44.0	110
90°	4.0	10.0	8.0	20.0	12.0	30.0	16.0	40.0	20.0	50.0	24.0	60.0	30.0	80.0	36.0	100	48.0	120
95°	4.4	10.9	8.7	21.8	13.1	32.7	17.5	43.7	21.8	54.6	26.2	65.5	32.8	87.3	39.3	109	52.4	131
100°	4.8	11.9	9.5	23.8	14.3	35.8	19.1	47.7	23.8	59.6	28.6	71.5	35.8	95.3	43.0	119	57.2	143
110°	5.7	14.3	11.4	28.6	17.1	42.9	22.8	57.1	28.5	71.4	34.3	85.7	42.8	114	51.4	143	68.5	171
120°	6.9	17.3	13.9	34.6	20.8	52.0	27.7	69.3	34.6	86.6	41.6	104	52.0	139	62.4	173	83.2	208
130°	8.6	21.5	17.2	42.9	25.7	64.3	34.3	85.8	42.9	107	51.5	129	64.4	172	77.3	215	103	257
140°	10.9	27.5	21.9	55.0	32.9	82.4	43.8	110	54.8	137	65.7	165	82.2	220	98.6	275	-	-
150°	14.9	37.3	29.8	74.6	44.7	112	59.6	149	74.5	187	89.5	224	112	299	-	-	-	-

Visit [spray.com/sprayware](http://spray.com/sprayware) for online flow rate and spray coverage calculators.





**PUMPS**

Every operation using spray nozzles requires a method to provide fluid flow. Fluid flow can be provided by gravity, air pressure or mechanical pumps. It is important to understand that pumping systems provide flow, not pressure. Pressure is the result of restricting flow. The output of an unrestricted pump is 0 psi (bar). When a restriction is placed in the flow, line pressure will result.

The main types of pumps are positive displacement and centrifugal. There are others, but the operational principles are the same as for positive displacement and centrifugal pumps.

**Positive displacement pumps**

A fixed volume of fluid is delivered for every stroke of a piston, or plunger or rotation of a shaft. Examples include piston pumps, plunger pumps, peristaltic pumps and gear pumps. Positive displacement pumps provide high pressure, and regardless of the system characteristics, will deliver a fixed flow every rotation. These pumps must have an unrestricted bypass valve and a pressure relief valve.

**Centrifugal pumps (velocity pumps)**

These pumps typically consist of a large vane (impeller) which is turned by a shaft inside a cavity (casing). The geometry of the impeller and casing moves the fluid in a tangential motion. The fluid gets restricted to a smaller volume and is then discharged into the system piping. These types of pumps typically operate at low pressure and high volume. They may also consist of several stages to increase the number of pressures available. These pumps have the unique feature of being able to run while the outlet is blocked. Since the pumps are velocity based, the impeller will spin in the casing fluid without “dead heading” the system itself. It will produce heat and may cavitate the fluid, but it will not build pressure like positive displacement pumps. However, a system bypass and pressure safety valve is still installed in the system to protect components.

**HOW PUMP TYPE AFFECTS NOZZLE SELECTION**

The flow rates and pressures required by the system will determine the pump choice. There are many styles, sizes and types of pumps available but these general guidelines should prove helpful.

- High flows usually require a centrifugal style pump
- High pressures usually require a positive displacement pump
- Variable Frequency Drive (VFD) pumps may be an option. These pumps allow variable control of speed and flow rates
- Consider the fluid. Specific gravity will affect pump flow rates just as it affects nozzle flow rates
- Pump efficiencies, heat, available power, maintenance and plant conditions should also be considered

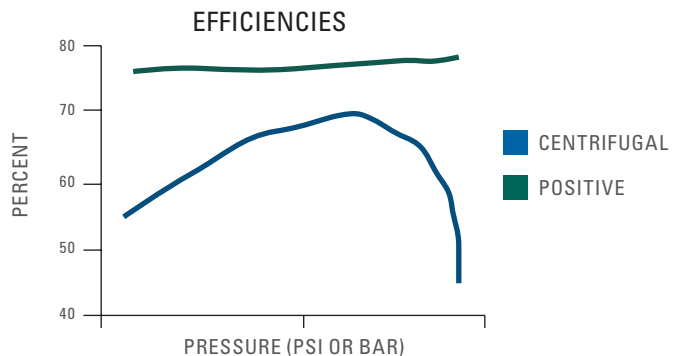
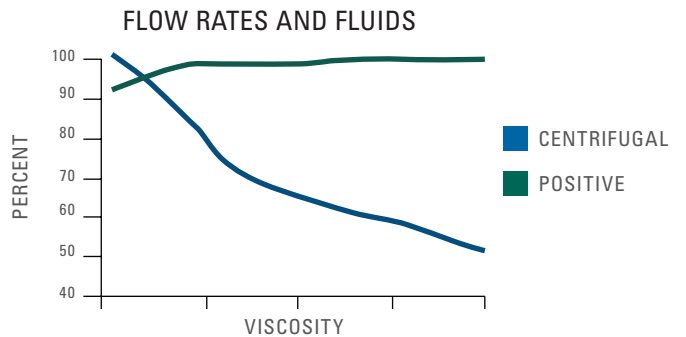
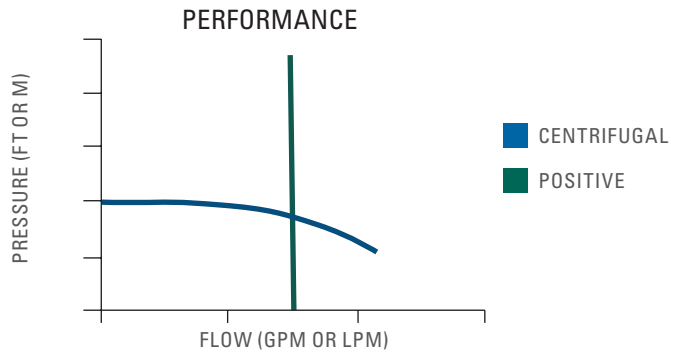

### SPRAY DROP SIZE (ATOMIZATION)

Accurate drop size information is an important factor in optimizing spray nozzle performance, particularly in industrial applications such as gas cooling, gas conditioning, fire suppression and spray drying.

Drop size refers to the size of the individual spray drops that comprise a nozzle’s spray pattern. Each spray provides a range of drop sizes; this range is referred to as drop size distribution. Drop size distribution is dependent on the spray pattern type and varies significantly from one type to another. The smallest drop sizes are achieved by air atomizing nozzles while the largest drops are produced by full cone hydraulic spray nozzles.

**ACTUAL DROP SIZES**

- 500 μm
- 1200 μm
- 5500 μm

One inch = 25,400 μm  
One millimeter = 1,000 μm  
μm = micrometers

Liquid properties, nozzle capacity, spraying pressure and spray angle also affect drop size. Lower spraying pressures provide larger drop sizes. Conversely, higher spraying pressures yield smaller drop sizes. Within each type of spray pattern the smallest capacities produce the smallest spray drops, and the largest capacities produce the largest spray drops.

### DROP SIZE BY SPRAY PATTERN TYPE AT VARIOUS PRESSURES AND CAPACITIES

Spray Pattern Type	10 psi (0.7 bar)			40 psi (2.8 bar)			100 psi (7 bar)		
	Capacity		VMD	Capacity		VMD	Capacity		VMD
	gpm	lpm	microns	gpm	lpm	microns	gpm	lpm	microns
Air Atomizing	.005	.02	20	.008	.03	15	12	45	400
	.02	.08	100	8	30	200			
Fine Spray	.22	.83	375	.03	.1	110	.05	.2	110
				.43	1.6	330	.69	2.6	290
Hollow Cone	.05	.19	360	.10	.38	300	.16	.61	200
	12	45	3400	24	91	1900	38	144	1260
Flat Fan	.05	.19	260	.10	.38	220	.16	.61	190
	5	18.9	4300	10	38	2500	15.8	60	1400
Full Cone	.10	.38	1140	.19	.72	850	.30	1.1	500
	12	45	4300	23	87	2800	35	132	1720

Based on a sampling of nozzles selected to show the wide range of possible drop sizes available.

### DROP SIZE TERMINOLOGY

Terminology is often a major source of discrepancy and confusion in understanding drop size. To accurately compare drop sizes from one nozzle to another, the same diameters have to be used. Drop size is usually expressed in microns (micrometers). Following are the most popular characteristic diameters and their definitions.

#### D<sub>v0.5</sub> : VOLUME MEDIAN DIAMETER (VMD)

A means of expressing drop size in terms of the volume of liquid sprayed. The Volume Median Diameter drop size when measured in terms of volume is a value where 50% of the total volume of liquid sprayed is made up of drops with diameters larger than the median value and 50% with smaller diameters.

#### D<sub>v0.9</sub>

A value where 90% of the total volume of liquid sprayed is made up of drops with diameters smaller or equal to this value. This measurement is best suited when complete evaporation of the spray is required.

#### D<sub>32</sub> : SAUTER MEAN DIAMETER (SMD)

A means of expressing the fineness of a spray in terms of the surface area produced by the spray. The Sauter Mean Diameter, is the diameter of a drop having the same volume-to-surface area ratio as the total volume of all the drops to the total surface area of all the drops.

**More drop size data is available on all types of spray nozzles. For more information contact your local Spraying Systems Co. sales engineer.**

### OPERATING PRESSURE

The values given in the tabulation sections of this catalog indicate the most commonly used pressure ranges for the associated spray nozzle or accessory.

**Contact your local Spraying Systems Co. sales engineer if your application requires pressure ranges beyond those stated in this catalog.**

### NOZZLE MATERIALS

For each nozzle there is a selection of “standard” materials that have been determined to meet the usual requirements of the applications most commonly associated with that type of nozzle. Standard materials include brass, steel, various stainless steels, hardened stainless steels, many plastics and various carbides. Spray nozzles can also be supplied in other materials upon special request.



 **NOZZLE WEAR**

Nozzle wear is typically characterized by an increase in nozzle capacity, followed by a general deterioration of the spray pattern. Flat fan spray nozzles with elliptical orifices experience a narrowing of the spray pattern. In other spray pattern types, the distribution within the spray pattern deteriorates without substantially changing the coverage area. The increase in nozzle capacity can sometimes be recognized by a decrease in system operating pressure, particularly when using positive displacement pumps.

Materials having harder surfaces generally provide longer wear life. The chart below provides standard abrasion resistance ratios for different materials to help you determine if you should consider a different material for your nozzles, orifice inserts and/or spray tips.

Materials that offer better corrosion resistance are also available. However, the rate of chemical corrosion on specific nozzle materials is dependent on the solution being sprayed. The corrosive properties of the liquid being sprayed, its percent concentration and temperature, as well as the corrosion resistance of the nozzle material to the chemical must all be considered.

**APPROXIMATE ABRASION RESISTANCE RATIOS**

Spray Nozzle Material	Resistance Ratio
Brass	1
Polypropylene	1–2
Stainless Steel	4–6
HASTELLOY	4–6
Hardened Stainless Steel	10–15
Stellite	10–15
Ceramics	90–200
Carbides	180–250

See Trademark Registration and Ownership, page i-1.

**VISCOSITY**

Absolute (dynamic) viscosity is the property of a liquid which resists change in the shape or arrangement of its elements during flow. Liquid viscosity is a primary factor affecting spray pattern formation and, to a lesser degree, capacity. High viscosity liquids – 100 cp or higher – require a higher minimum pressure to begin formation of a spray pattern and provide narrower spray angles as compared to those of water.

**TEMPERATURE**

The values given in this catalog are based on spraying water at 70°F (21°C). Although liquid temperature changes do not affect the spray performance of a nozzle, they often affect viscosity, surface tension and specific gravity which do influence spray nozzle performance.

**SURFACE TENSION**

The surface of a liquid tends to assume the smallest possible size; acting, in this respect, like a membrane under tension. Any portion of the liquid surface exerts a tension upon adjacent portions or upon other objects with which it is in contact. This force is in the plane of the surface and its amount per unit of length is surface tension. Its value for water is about 73 dynes per cm at 70°F (21°C). The main effects of surface tension are on minimum operating pressure, spray angle and drop size.

The property of surface tension is more apparent at low operating pressures. A higher surface tension reduces the spray angle, particularly on hollow cone and flat fan spray nozzles. Low surface tensions can allow a nozzle to be operated at a lower pressure.

**SUMMARY OF SPRAY PERFORMANCE CONSIDERATIONS**

The factors below can affect a spray nozzle’s performance, and the effects can vary based on nozzle type and size. In some applications, there are interrelated factors which may counteract certain effects. For instance, in the case of a hollow cone spray nozzle, increasing the temperature of the liquid decreases the specific gravity, thereby producing a greater flow rate while at the same time decreasing the viscosity which reduces the flow.

Nozzle Characteristics	Increase in Operating Pressure	Increase in Specific Gravity	Increase in Viscosity	Increase in Fluid Temperature	Increase in Surface Tension
Pattern Quality	Improves	Negligible	Deteriorates	Improves	Negligible
Drop Size	Decreases	Negligible	Increases	Decreases	Increases
Spray Angle	Increases then decreases	Negligible	Decreases	Increases	Decreases
Capacity	Increases	Decreases	Full/hollow cone – increases Flat – decreases	Depends on fluid sprayed and nozzle used	No effect
Impact	Increases	Negligible	Decreases	Increases	Negligible
Velocity	Increases	Decreases	Decreases	Increases	Negligible
Wear	Increases	Negligible	Decreases	Depends on fluid sprayed and nozzle used	No effect



**ESTIMATING PRESSURE DROPS THROUGH FLUIDLINE ACCESSORIES**

The rated capacities listed in this catalog for valves, strainers and fittings typically correspond to pressure drops of approximately 5% of their maximum operating pressure.

Visit [spray.com/sprayware](http://spray.com/sprayware) for an online pressure drop calculator. Or contact your local sales engineer.

**APPROXIMATE FRICTION LOSS IN PIPE FITTINGS IN EQUIVALENT FEET (METERS) OF STRAIGHT PIPE**

Use the chart below to determine the equivalent length of pipe through fittings to equate the friction loss.

Pipe Size Standard Wt. (in.)	Actual Inside Dia. in. (mm)	Gate Valve FULL OPEN ft. (m)	Globe Valve FULL OPEN ft. (m)	45° Elbow ft. (m)	Run of Standard Tee ft. (m)	Standard Elbow or Run of Tee Reduced 1/2 ft. (m)	Standard Tee Through Side Outlet ft. (m)
1/8	.269 (6.8)	.15 (.05)	8.0 (2.4)	.35 (.11)	.40 (.12)	.75 (.23)	1.4 (.43)
1/4	.364 (9.2)	.20 (.06)	11.0 (3.4)	.50 (.15)	.65 (.20)	1.1 (.34)	2.2 (.67)
1/2	.622 (15.8)	.35 (.11)	18.6 (5.7)	.78 (.24)	1.1 (.34)	1.7 (.52)	3.3 (1.0)
3/4	.824 (21)	.44 (.13)	23.1 (7.0)	.97 (.30)	1.4 (.43)	2.1 (.64)	4.2 (1.3)
1	1.049 (27)	.56 (.17)	29.4 (9.0)	1.2 (.37)	1.8 (.55)	2.6 (.79)	5.3 (1.6)
1-1/4	1.380 (35)	.74 (.23)	38.6 (11.8)	1.6 (.49)	2.3 (.70)	3.5 (1.1)	7.0 (2.1)
1-1/2	1.610 (41)	.86 (.26)	45.2 (13.8)	1.9 (.58)	2.7 (.82)	4.1 (1.2)	8.1 (2.5)
2	2.067 (53)	1.1 (.34)	58 (17.7)	2.4 (.73)	3.5 (1.1)	5.2 (1.6)	10.4 (3.2)
2-1/2	2.469 (63)	1.3 (.40)	69 (21)	2.9 (.88)	4.2 (1.3)	6.2 (1.9)	12.4 (3.8)
3	3.068 (78)	1.6 (.49)	86 (26)	3.6 (1.1)	5.2 (1.6)	7.7 (2.3)	15.5 (4.7)
4	4.026 (102)	2.1 (.64)	113 (34)	4.7 (1.4)	6.8 (2.1)	10.2 (3.1)	20.3 (6.2)
5	5.047 (128)	2.7 (.82)	142 (43)	5.9 (1.8)	8.5 (2.6)	12.7 (3.9)	25.4 (7.7)
6	6.065 (154)	3.2 (.98)	170 (52)	7.1 (2.2)	10.2 (3.1)	15.3 (4.7)	31 (9.4)

**AIR FLOW (SCFM AND NLPM) THROUGH SCHEDULE 40 STEEL PIPE**

Applied Pressure psig	Nominal Standard Pipe Size (scfm)											Applied Pressure bar	Nominal Standard Pipe Size (nlpm)										
	1/8"	1/4"	3/8"	1/2"	3/4"	1"	1-1/4"	1-1/2"	2"	2-1/2"	3"		1/8"	1/4"	3/8"	1/2"	3/4"	1"	1-1/4"	1-1/2"	2"	2-1/2"	3"
5	.5	1.2	2.7	4.9	6.6	13.0	27	40	80	135	240	0.3	14.2	34.0	76.5	139	187	370	765	1130	2265	3820	6796
10	.8	1.7	3.9	7.7	11.0	21	44	64	125	200	370	0.7	22.7	48.1	110	218	310	595	1245	1810	3540	5665	10480
20	1.3	3.0	6.6	13.0	18.5	35	75	110	215	350	600	1.4	36.8	85.0	187	370	525	990	2125	3115	6090	9910	16990
40	2.5	5.5	12.0	23	34	62	135	200	385	640	1100	2.8	70.8	155	340	650	960	1755	3820	5665	10900	18120	31150
60	3.5	8.0	18.0	34	50	93	195	290	560	900	1600	4.1	99.1	227	510	965	1415	2630	5520	8210	15860	25485	45305
80	4.7	10.5	23	44	65	120	255	380	720	1200	2100	5.5	133	297	650	1245	1840	3400	7220	10760	20390	33980	59465
100	5.8	13.0	29	54	80	150	315	470	900	1450	2600	6.9	164	370	820	1530	2265	4250	8920	13310	25485	41060	73625



FLOW OF WATER THROUGH SCHEDULE 40 STEEL PIPE – PRESSURE DROP

Flow gpm	Pressure Drop in psi for Various Pipe Diameters 10 ft. Length Pipe																Flow lpm	Pressure Drop in bar for Various Pipe Diameters 10 m Length Pipe																
	1/8"	1/4"	3/8"	1/2"	3/4"	1"	1 1/4"	1 1/2"	2"	2 1/2"	3"	3 1/2"	4"	5"	6"	8"		1/8"	1/4"	3/8"	1/2"	3/4"	1"	1 1/4"	1 1/2"	2"	2 1/2"	3"	3 1/2"	4"	5"	6"	8"	
.3	.42																1	.07																
.4	.70	.16															1.5	.16	.04															
.5	1.1	.24															2	.26	.06															
.6	1.5	.33															2.5	.40	.08															
.8	2.5	.54	.13														3	.56	.12	.03														
1.0	3.7	.83	.19	.06													4	.96	.21	.05	.02													
1.5	8.0	1.8	.40	.12													6	2.0	.45	.10	.03													
2.0	13.4	3.0	.66	.21	.05												8	3.5	.74	.17	.05	.01												
2.5		4.5	1.0	.32	.08												10		1.2	.25	.08	.02												
3.0		6.4	1.4	.43	.11												12		1.7	.35	.11	.03												
4.0		11.1	2.4	.74	.18	.06											15		2.6	.54	.17	.04	.01											
5.0			3.7	1.1	.28	.08											20			.92	.28	.07	.02											
6.0			5.2	1.6	.38	.12											25			1.2	.45	.11	.03											
8.0			9.1	2.8	.66	.20	.05										30			2.1	.62	.15	.04	.01										
10				4.2	1.0	.30	.08										40				1.1	.25	.08	.02										
15					2.2	.64	.16	.08									60				.54	.16	.04	.02	.006									
20					3.8	1.1	.28	.13	.04								80				.93	.28	.07	.03	.009									
25						1.7	.42	.19	.06								100					.43	.12	.05	.01									
30						2.4	.59	.27	.08								115					.58	.14	.06	.015									
35						3.2	.79	.36	.11	.04							130					.72	.18	.08	.02	.01								
40							1.0	.47	.14	.06							150						.23	.10	.03	.012								
45							1.3	.59	.17	.07							170						.29	.13	.04	.016								
50							1.6	.72	.20	.08							190						.36	.16	.05	.02								
60							2.2	1.0	.29	.12	.04						230						.50	.23	.07	.03	.009							
70								1.4	.38	.16	.05						260							.32	.09	.04	.01							
80								1.8	.50	.20	.07						300							.38	.11	.04	.02	.007						
90								2.2	.62	.25	.09	.04					340							.50	.14	.06	.02	.009						
100								2.7	.76	.31	.11	.05					380							.61	.18	.07	.03	.01						
125									1.2	.47	.16	.08	.04				470								.28	.11	.04	.02	.009					
150									1.7	.67	.22	.11	.06				570								.39	.15	.05	.03	.01					
200									2.9	1.2	.39	.19	.10				750								.64	.26	.09	.04	.02	.007				
250										.59	.28	.15	.05				950									.14	.06	.03	.01					
300											.84	.40	.21	.07			1150									.19	.09	.05	.02					
400												.70	.37	.12	.05		1500										.16	.08	.03	.01				
500													.57	.18	.07		1900											.13	.04	.02				
750														.39	.16	.04	2800												.09	.03	.009			
1000															.68	.27	.07	3800											.16	.06	.02			
2000																1.0	.26	7500												.23	.06			

Recommended capacity range for each size is shown in shaded areas.  
 For pipe lengths greater than 10 ft. (3 m), the pressure loss is proportional to the length. For 50 ft. (15 m) of pipe, the pressure drop is approximately 5 times the value in the table.

## MAINTAINING SPRAY NOZZLES

Like any precision component, spray nozzles wear over time. Spray nozzle wear can be hard to detect. Small changes in performance can result in quality problems and wasted water, chemicals and electricity. The cost of using worn nozzles can be very significant – tens of thousands of dollars or more per year. Detecting nozzle wear in the early stages can prevent a significant profit drain.

### USING NOZZLES THAT ARE SPRAYING JUST 15% OVER THE RATED CAPACITY\*

	WASTE	COST OF EXCESS
WATER	1,701,835 gallons (6,442,146 liters)	US \$4,680
CHEMICALS	170,165 gallons (644,145 liters)	US \$170,164
WASTEWATER DISPOSAL	1,872,000 gallons (7,086,291 liters)	US \$7,956
<b>TOTAL COST OF USING WORN NOZZLES:</b>		<b>US \$182,800</b>

\*Based on total system flow of 100 gpm (379 lpm). Water cost of US \$2.75/1000 gallons (3,785 liters). Chemical cost of US \$1.00 per gallon (liter) and a dilution ratio of 10:1. System operates 2080 hours per year. Increased electricity cost, scrap and downtime due to quality problems are not included.

## DETECTING WORN SPRAY NOZZLES

Visually inspecting nozzles is a start but unless wear is significant, it may not be detectable.

The graphic below illustrates this problem. The spray tip on the left is new and sprays properly. The spray tip on the right is worn and sprays 30% over capacity. The difference is undetectable by inspecting the nozzle, but spray collection data reveals the difference between the two tips.

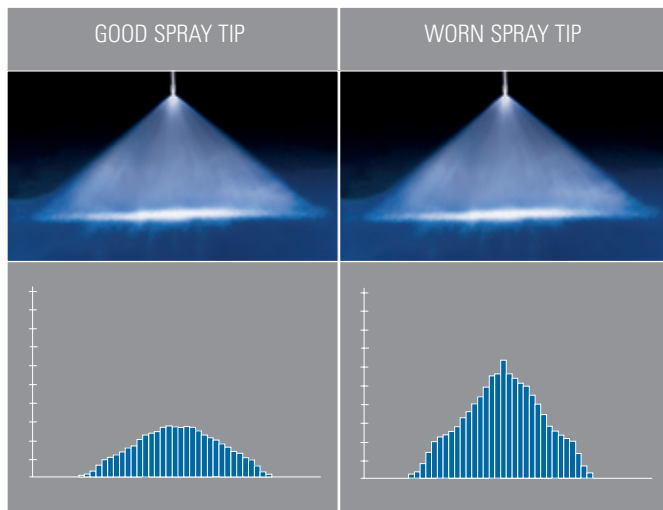

### WATCH FOR THESE SIGNS OF NOZZLE WEAR:

- **Quality control issues and increased scrap.** Check for uneven coating, cooling, drying or cleaning and changes in temperature, dust content and humidity
- **Flow rate change:**
  - For centrifugal pumps: monitor flow meter readings to detect increases or collect and measure the flow from the spray nozzle for a given period of time at a specific pressure and compare them to flow rate readings from new, unused spray nozzles
  - For positive displacement pumps: monitor the liquid line pressure for decreases; the flow rate will remain constant
- **Spray pressure in the nozzle manifold:**
  - For centrifugal pumps: monitor for increases in liquid volume sprayed. The spraying pressure is likely to remain the same
  - For positive displacement pumps: monitor pressure gauge for decreases in pressure and reduction in impact on sprayed surfaces. The liquid volume sprayed is likely to remain the same. Also, monitor for increases in pressure due to clogged spray nozzles
- **Deterioration of spray pattern quality.** Visually inspect the spray pattern for changes. Check the spray angle with a protractor. Measure the width of the spray pattern on the sprayed surface

## REPLACING WORN NOZZLES

Inspecting and maintaining your nozzles on a regular basis will help identify wear and extend service life. However, wear will occur over time and the only solution is to replace your nozzles.

Here are a few guidelines to help you determine the optimal replacement interval:

- Are worn nozzles affecting product or process quality? If so, replace nozzles as soon as any wear is evident
- Is water conservation a priority? If so, replace nozzles as soon as wear is evident
- How much are you spending by continuing to use worn nozzles? How do the additional costs for water, chemicals, electricity and wastewater disposal compare with the cost of replacement nozzles?
- Is precise spray performance important to your overall process? If so, you may want to set pre-determined dates for nozzle replacement such as annual or semi-annual maintenance shutdowns

**For more information on nozzle maintenance and replacement, visit [spray.com](http://spray.com). Or, contact your local sales engineer for assistance developing a nozzle maintenance program.**

TABLE OF EQUIVALENTS

VOLUMETRIC UNIT

	Cubic Centimeter	Fluid Ounce	Pound of Water	Liter	US Gallon	Cubic Foot	Cubic Meter
Cubic Centimeter	•	.034	$2.2 \times 10^{-3}$	.001	$2.64 \times 10^{-4}$	$3.53 \times 10^{-5}$	$1.0 \times 10^{-6}$
Fluid Ounce	29.4	•	.065	.030	$7.81 \times 10^{-3}$	$1.04 \times 10^{-3}$	$2.96 \times 10^{-5}$
Pound of Water	454	15.4	•	.454	.12	.016	$4.54 \times 10^{-4}$
Liter	1000	33.8	2.2	•	.264	.035	.001
US Gallon	3785	128	8.34	3.785	•	.134	$3.78 \times 10^{-3}$
Cubic Foot	28314	958	62.4	28.3	7.48	•	.028
Cubic Meter	$1.0 \times 10^6$	$3.38 \times 10^4$	2205	1000	264	35.3	•

LIQUID PRESSURE

	lb/in <sup>2</sup> (psi)	Ft Water	Kg/Cm <sup>2</sup>	Atmosphere	Bar	Inch Mercury	kPa (kilopascal)
lb/in <sup>2</sup> (psi)	•	2.31	.070	.068	.069	2.04	6.895
Ft Water	.433	•	.030	.029	.030	.882	2.99
Kg/Cm <sup>2</sup>	14.2	32.8	•	.968	.981	29.0	98
Atmosphere	14.7	33.9	1.03	•	1.01	29.9	101
Bar	14.5	33.5	1.02	.987	•	29.5	100
Inch Mercury	.491	1.13	.035	.033	.034	•	3.4
kPa (kilopascal)	.145	.335	.01	.009	.01	.296	•

LINEAR UNIT

	Micron	Mil	Millimeter	Centimeter	Inch	Foot	Meter
Micron	•	.039	.001	$1.0 \times 10^{-4}$	$3.94 \times 10^{-5}$	–	–
Mil	25.4	•	$2.54 \times 10^{-2}$	$2.54 \times 10^{-3}$	.001	$8.33 \times 10^{-5}$	–
Millimeter	1000	39.4	•	.10	.0394	$3.28 \times 10^{-3}$	.001
Centimeter	10000	394	10	•	.394	.033	.01
Inch	$2.54 \times 10^4$	1000	25.4	2.54	•	.083	.0254
Foot	$3.05 \times 10^5$	$1.2 \times 10^4$	305	30.5	12	•	.305
Meter	$1.0 \times 10^6$	$3.94 \times 10^4$	1000	100	39.4	3.28	•

MISCELLANEOUS EQUIVALENTS

Unit	Equivalent
Ounce	28.35 g
Pound	.4536 kg
Horsepower	.746 kW
British Thermal Unit	.252 kcal
Square Inch	6.452 cm <sup>2</sup>
Square Foot	.09290 m <sup>2</sup>

MISCELLANEOUS FORMULAS

Unit	Formula
Fahrenheit (°F)	= $9/5 (°C) + 32$
Celsius (°C)	= $5/9 (°F - 32)$
Circumference of a Circle	= $3.1416 \times \text{Dia.}$
Area of a Circle	= $.7854 \times (\text{Dia.})^2$
Volume of a Sphere	= $.5236 \times (\text{Dia.})^3$
Area of a Sphere	= $3.1416 \times (\text{Dia.})^2$

DIMENSIONS

The catalog tabulations show orifice dimensions as “Nom.” (nominal).



READ THE FOLLOWING INSTRUCTIONS:



**WARNING:**

All safety related and operating instructions should be read before the nozzle is operated. Follow all operating instructions. Failure to do so could result in serious or fatal injury.



**WARNING:**

Spraying Systems Co. strongly recommends the use of appropriate safety equipment when working with potentially hazardous chemicals.

**This equipment includes but is not limited to:**

- Protective hat
- Safety glasses or face shield
- Chemical-resistant gloves and apron
- Long sleeve shirt and long pants



**WARNING:**

It is important to recognize proper safety precautions when using a pressurized spray system. Fluids under pressure can penetrate skin and cause severe injury. Seek medical attention immediately.



**WARNING:**

Before use, be sure appropriate connections are secure and made to withstand weight and reaction forces of the operating unit.

NOTE: Always remember to carefully read the chemical manufacturer's label and follow all directions.



**WARNING:**

When dealing with pressure applications, the system pressure should never exceed the lowest rated component. Always know your system and all component capabilities, maximum pressures and flow rates.



**WARNING:**

It is important to operate equipment within the temperature range of all components. Also, insure appropriate time lapse or proper safety equipment is used when handling components after they're exposed to high temperatures.



**WARNING:**

Before performing any maintenance, make sure all liquid supply lines to the machine are shut off and/or disconnected and chemicals/fluids are drained and not pressurized.



**WARNING:**

Do not use any equipment outside the intended purposes of the product. Misuse can result in personal injury or product damage.



**WARNING:**

The use of any chemicals requires careful control of all worker hygiene. Follow all MSDS or safety precautions provided by the manufacturer.



**WARNING:**

Spraying Systems Co. does not manufacture or supply any of the chemicals used with our nozzles and is not responsible for their effects. Because of the large number of chemicals that could be used and their different chemical reactions, the buyer and user of this equipment should determine compatibility of the materials used and any of the potential hazards involved.





## AIR ATOMIZING SPRAY NOZZLES

CHEMICAL INJECTION • PASSIVATING  
COATING • STERILIZING • FOGGING  
HUMIDIFYING • MISTING • COATING  
MOISTURIZING • GAS COOLING  
LUBRICATING

# AIR ATOMIZING NOZZLES INTRODUCTION

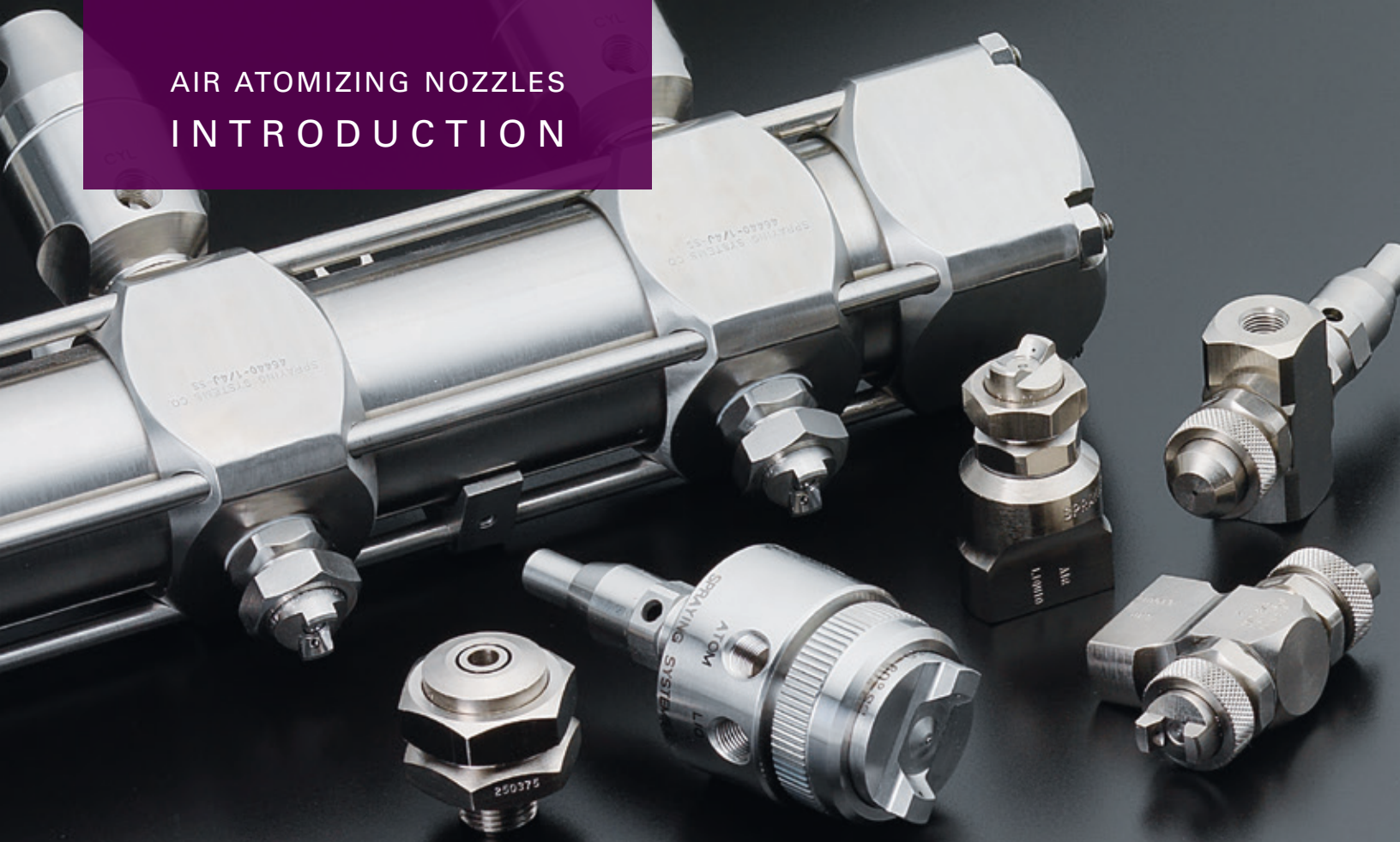

## LARGEST SELECTION OF NOZZLES IN THE INDUSTRY

### INTRODUCTION

If your application requires air atomizing – or “two-fluid” – nozzles, you’ll find information on the largest selection available in the industry in this section. Choose from a wide variety of nozzle assemblies and spray set-ups to get the precise performance you require.

Fluid lines for air atomizing nozzles can be pressurized or supplied using a siphon- or gravity-fed configuration. Nozzles equipped with clean-out and/or shut-off needles may require an additional air line. All air and fluid lines should be equipped with the proper filters, regulators and valves.

Air atomizing nozzles require spray set-ups, which consist of an air cap and fluid cap. Hundreds of spray set-ups are available to provide the precise performance you require.

### PRODUCT RANGE

#### **J Series Nozzles**

Available in many configurations with flow rates up to 29 gpm (110 lpm).

#### **JJ Compact Series Nozzles**

Available with clean-out needles and shut-off needles; flow rates range up to 33 gph (126 lph).

#### **QMJ Series Nozzles**

Quick-connect convenience for spray set-up installation and flow rates up to 26 gph (98 lph).

#### **Variable Spray Nozzles**

Independent control of liquid, atomizing air and fan air pressures enables fine tuning of spray performance.

#### **High Efficiency, High Flow Spray Nozzles**

Very small droplet size with low air consumption and flow rates up to 45 gpm (170 lpm).



# AIR ATOMIZING NOZZLES TABLE OF CONTENTS



## J AND JJ NOZZLE SERIES

	PAGE
Quick Reference Guide	B5
1/4J Series	B6
1/8JJ Series	B8
1/2J Series	B9
1J Series	B10

## QUICKMIST® NOZZLE SERIES

	PAGE
Quick Reference Guide	B11
QMJ Series	B11

## VARIABLE SPRAY NOZZLE SERIES

	PAGE
Quick Reference Guide	B12
VAA Series	B13

## HIGH EFFICIENCY, HIGH FLOW SPRAY NOZZLE SERIES

	PAGE
Quick Reference Guide	B14
FloMax® Series	B14

### OPTIMIZE PERFORMANCE WITH:



Use air atomizing nozzles with clean-out needles to eliminate clogging and ensure optimum performance.  
**See page B7**



Use liquid strainers and air filters to reduce maintenance and extend nozzle life.  
**See page G4**



Pressure tanks provide a convenient liquid supply source for low volume spraying.  
**See page G23**

**OVERVIEW: AIR ATOMIZING NOZZLE SET-UPS**

Liquid can be supplied to the nozzle under pressure or it can be supplied through a liquid siphon or gravity-feed.

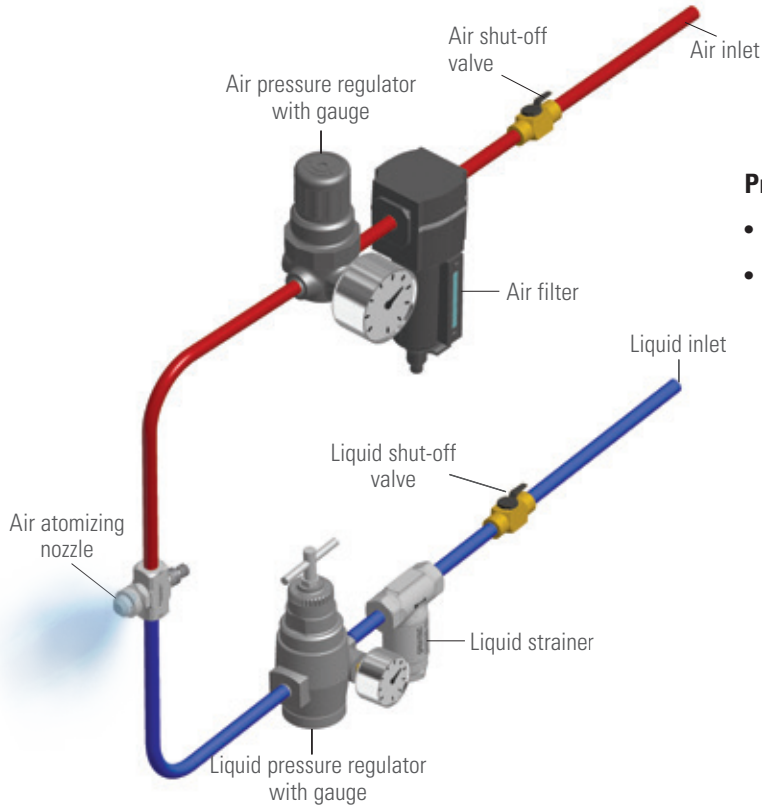

**Pressure Spray Set-Ups**

- Liquid is supplied to the nozzle under pressure
- Air and liquid can be externally or internally mixed to produce a completely atomized spray

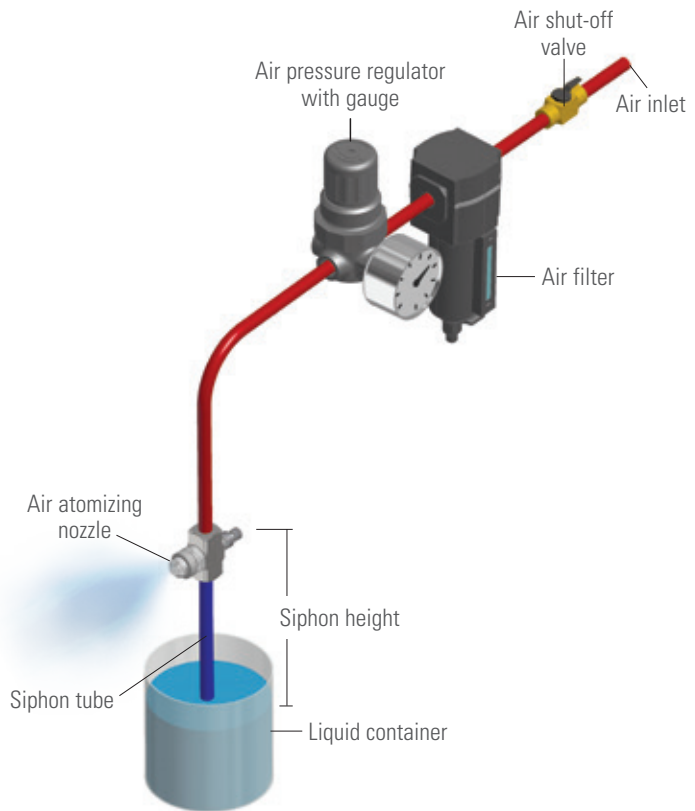

**Siphon/Gravity-Fed Spray Set-Ups**

- Liquid is supplied via liquid siphon or is gravity-fed
- These set-ups are designed to draw liquid through the feed line into the air flow where it is atomized

**PLACING YOUR ORDER**

Call **1.800.95.SPRAY** for application assistance or to place an order.

FOR DETAILED SPRAY SET-UP PERFORMANCE DATA  
**SEE SECTION D**

**OVERVIEW: J AND JJ SERIES NOZZLES**

- Liquid and compressed air enter the nozzle body and are mixed by the spray set-up to produce a finely atomized spray pattern
- Spray set-ups, consisting of an air cap and a fluid cap, can mix the fluids either internally or externally
- Hundreds of spray set-ups are available to produce cone and flat spray patterns
- A wide variety of nozzle bodies are available for convenient mounting and positioning
- JJ compact nozzle bodies are available for applications where space is limited
- Models available with clean-out needles, shut-off needles, swivels and strainers to optimize performance

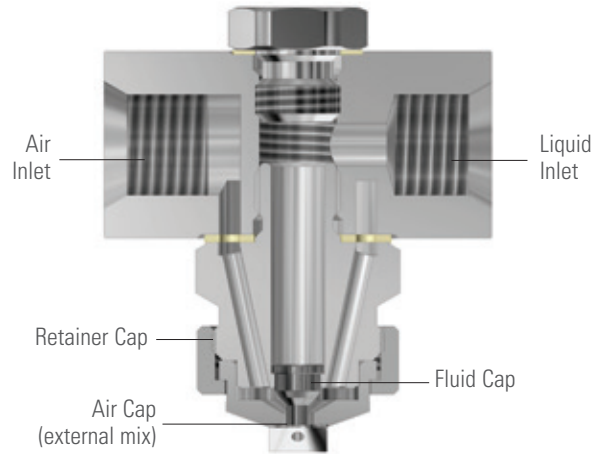

**1/4J Nozzle**

Air and liquid enter the air atomizing nozzle body and are combined by the spray set-up to generate finely atomized droplets.

**QUICK REFERENCE GUIDE**

Product Number	Inlet Connection Size (in.)	Max Flow	Max Temp (liquid)	Spray Set-Ups
<b>1/4J Series</b>	1/4 (F) NPT or BSPT	72 gph (273 lph)	160°F (71°C)	1/4J set-ups (page D32)
<b>1/8JJ Series</b>	1/8 (F) NPT or BSPT	33.2 gph (126 lph)	160°F (71°C)	1/8JJ set-ups (page D35)
<b>1/2J Series</b>	1/2 (F) NPT or BSPT	306 gph (1158 lph)	160°F (71°C)	1/2J set-ups (page D43)
<b>1J Series</b>	1 (F) NPT or BSPT	29 gpm (110 lpm)	160°F (71°C)	1J set-ups (page D49)

**1/4J SERIES NOZZLES**

- J Series nozzles consist of a nozzle body and a spray set-up
- A wide variety of spray set-ups are available with flow rates up to 72 gph (273 lph) in various spray patterns.
- Basic 1/4J bodies have liquid and air inlets on opposing sides of the nozzle bodies. Nozzle bodies include a removable plug so needle assemblies can be added in the future
- Nickel-plated brass or stainless steel construction



**1/4J  
Nozzles**

**1/4J NOZZLE OPTIONS**

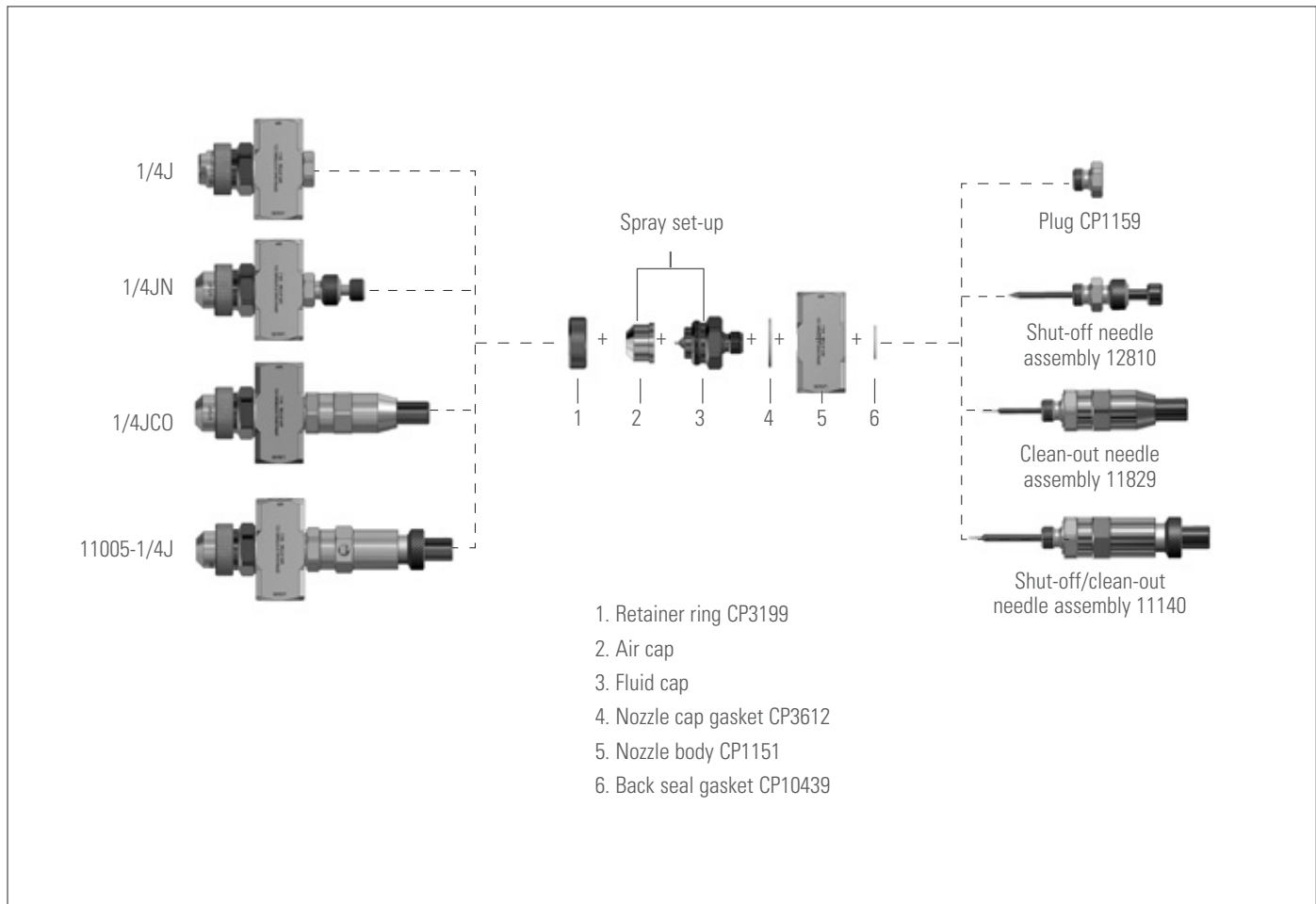

1/4J NOZZLE OPTIONS



**1/4JN** – Manual shut-off needle to stop liquid flow



**1/4JCO** – Manual clean-out needle to clear obstructions from the fluid orifice



**11005-1/4J** – Combination shut-off/clean-out needle



**1/4JBC** – Air and liquid inlets at the back of the nozzle body, in line with the spray direction



**8650** – Cluster type assembly includes four or five spray set-ups



**6552-1/8JAC** – Miniature design is only 1/2" thick with a 1-5/32" by 1-1/4" rectangular face. The air and liquid inlets on the same side of the nozzle body – 90° to the spray direction



**1/4JBCJ** – Steam jacket around the nozzle body for spraying liquids too viscous to spray at room temperatures



**1/4JAC** – Air and liquid inlets on the same side of the nozzle body – 90° to the spray direction



**1/4JACN** – Air and liquid inlets on the same side of the nozzle body – 90° to spray direction – with manual shut-off needle

WALL MOUNT ADAPTER OPTIONS

**Thick wall adapters** for 1/4J with 3/4" NPT or BSPT (M) adapter connections use CP3376 wall mount adapter. Replace retainer rings on nozzle assemblies and fit into threaded wall openings. *See page G22 for more details*

**Thin wall adapters** for 1/4J assemblies. For thin walls add adapter CP6378 locknut and CP2804-3 gasket to CP3376 wall mount adapter to provide secure mounting. *See page G22 for more details*

PLACING YOUR ORDER

Call 1.800.95.SPRAY for application assistance or to place an order.

FOR DETAILED SPRAY SET-UP PERFORMANCE DATA  
SEE SECTION D



**1/8JJ SERIES NOZZLES**

- Compact JJ Series nozzles consist of a nozzle body and a spray set-up
- A wide variety of spray set-ups are available with flow rates up to 33 gph (126 lph) in various spray patterns
- 1/8JJ bodies have liquid and air inlets on opposing sides of the nozzle bodies. Nozzle bodies include a removable plug so needle assemblies can be added in the future
- Nickel-plated brass or stainless steel construction



**1/8JJ  
Nozzle**

**JJ SERIES SPRAY NOZZLE OPTIONS**

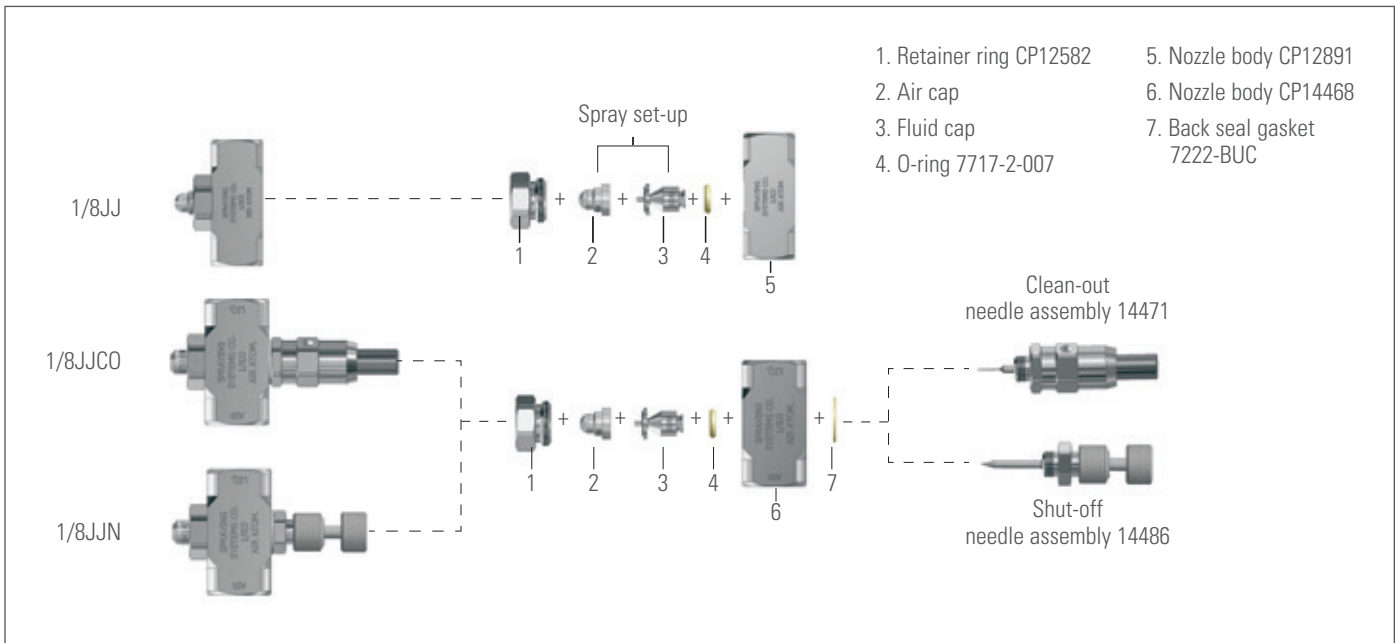

**1/8JJN** – Manual shut-off needle to stop liquid flow



**1/8JJCO** – Manual clean-out needle to clear obstructions from the fluid orifice

**PLACING YOUR ORDER**

**Call 1.800.95.SPRAY for application assistance or to place an order.**

**FOR DETAILED SPRAY SET-UP PERFORMANCE DATA  
SEE SECTION D**



**1/2J SERIES NOZZLES**

- J Series nozzles consist of a nozzle body and a spray set-up
- A wide variety of spray set-ups are available with flow rates up to 306 gph (1158 lph) in various spray patterns
- Basic 1/2J bodies have liquid and air inlets on opposing sides of the nozzle bodies. Nozzle bodies include a removable plug so needle assemblies can be added in the future
- Nickel-plated brass or stainless steel construction



**1/2J NOZZLE OPTIONS**

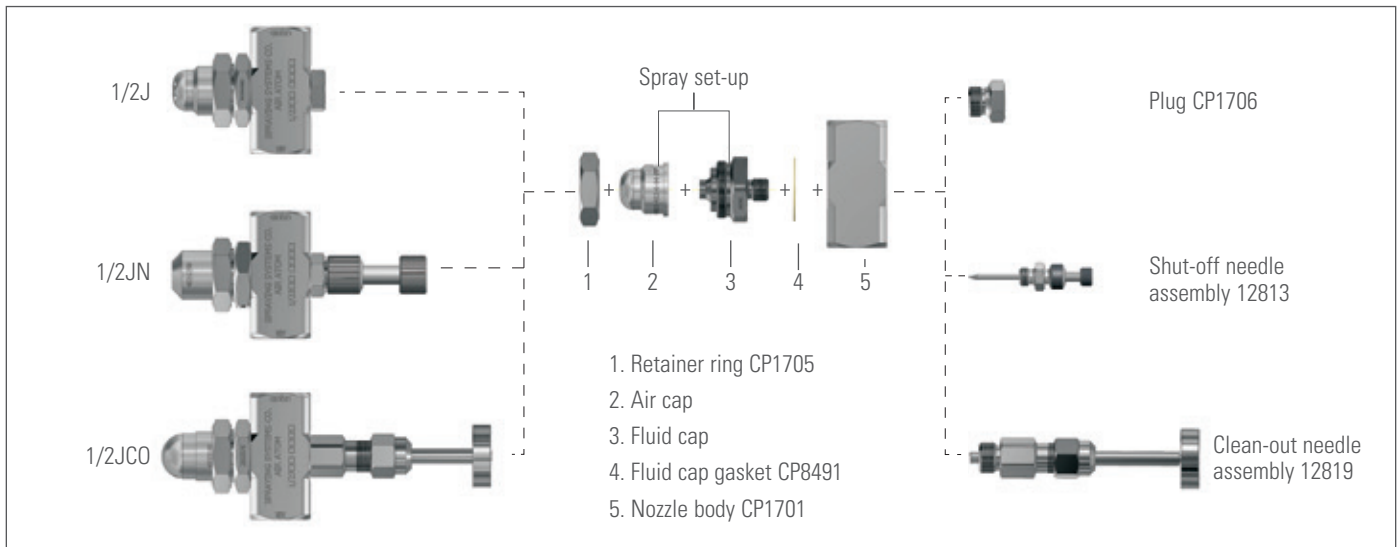

**1/2JN** – Manual shut-off needle to stop liquid flow



**1/2JCO** – Manual clean-out needle to clear obstructions from the fluid orifice



**1/2JBC** – Air and liquid inlets at the back of the nozzle body, in line with the spray direction



**1/2JBCJ** – Steam jacket around the nozzle body for spraying liquids too viscous to spray at room temperatures



**1/2-2J** – 1/2" air and liquid inlet connections on opposing sides of the nozzle body with two opposing spray set-ups

**WALL MOUNT ADAPTER OPTIONS**

**Thick wall adapters** for 1/4J with 3/4" NPT or BSPT (M) adapter connections use CP4886 wall mount adapters. Replace retainer rings on nozzle assemblies and fit into threaded wall openings. *See page G22 for more details*

**1J SERIES NOZZLES**

- J Series nozzles consist of a nozzle body and a spray set-up
- A wide variety of spray set-ups are available with flow rates up to 29 gpm (110 lpm) in various spray patterns
- Basic 1J bodies have liquid and air inlets on opposing sides of the nozzle bodies. Nozzle bodies include a removable plug so needle assemblies can be added in the future
- Nickel-plated brass or stainless steel construction



**1J Nozzle**

**1J NOZZLE OPTIONS**

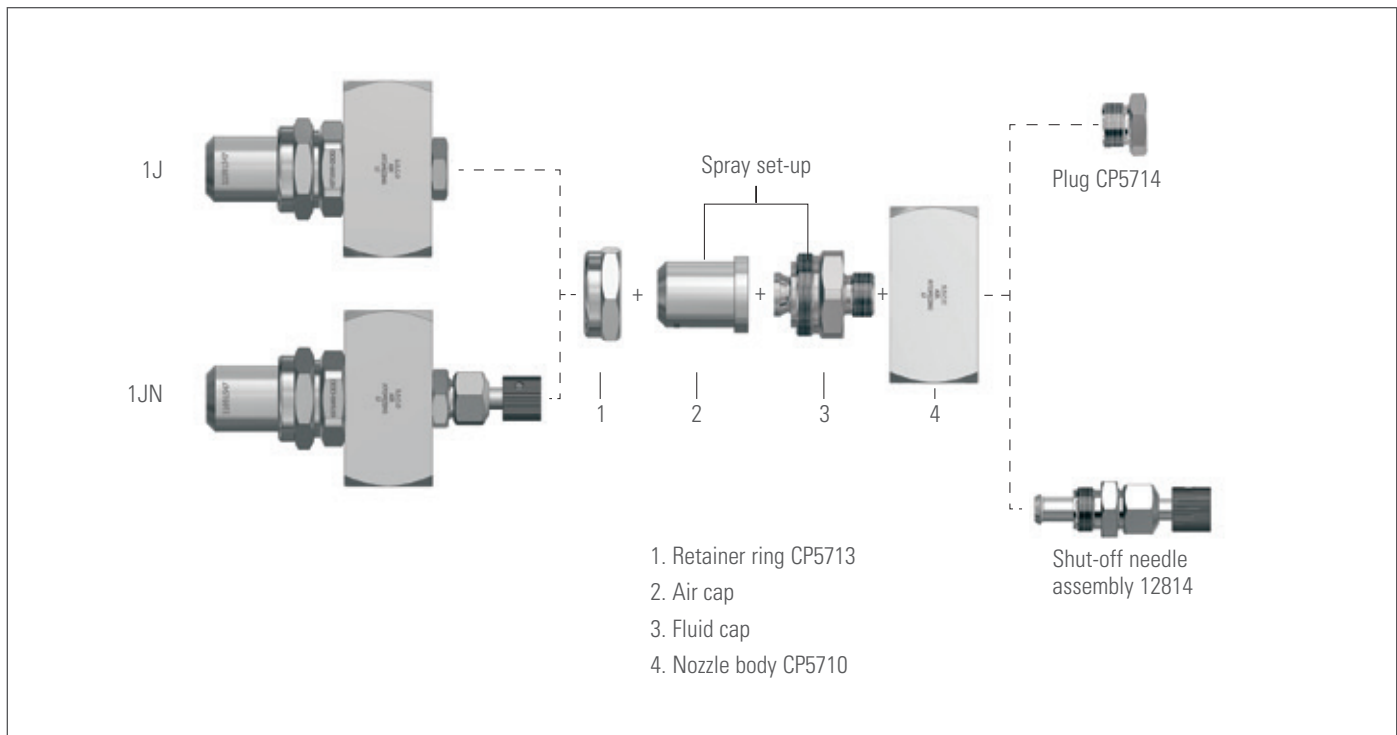

**1JN** – Manual shut-off needle to stop liquid flow

**PLACING YOUR ORDER**

**Call 1.800.95.SPRAY for application assistance or to place an order.**

**FOR DETAILED SPRAY SET-UP PERFORMANCE DATA  
SEE SECTION D**

**OVERVIEW: QUICKMIST® SERIES NOZZLES**

- Liquid and compressed air enter the nozzle body and are mixed by the spray set-up to produce a very finely atomized spray pattern
- The efficient design of QuickMist nozzles uses less air than typical air atomizing nozzles
- No tools are required for cleaning or replacement of spray set-ups
- Lightweight fluoropolymer material provides excellent chemical resistance
- Wide variety of spray set-ups available

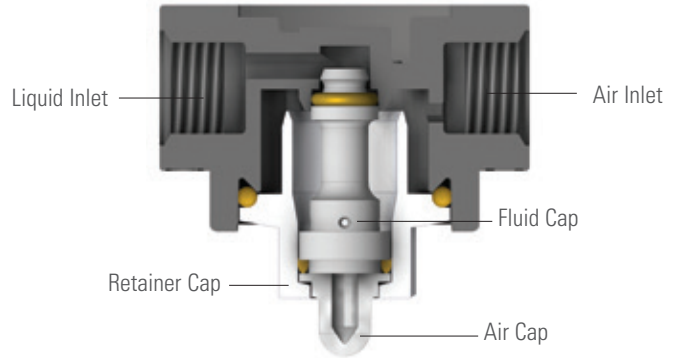

**1/4QMJ Nozzle**

Air and liquid enter the air atomizing nozzle body and are combined by the spray set-up to generate finely atomized droplets.

**QUICK REFERENCE GUIDE**

Product Number	Inlet Connection Size (in.)	Max Flow	Max Temp (liquid)	Spray Set-Ups
<b>QMJ Series</b>	1/4 (F) NPT or BSPT	26 gph (98 lph)	200°F (93°C)	SUQ set-ups (page D54) 

**QUICKMIST® SERIES NOZZLES – 1/4QMJ AND 1/4QMJML**

- QuickMist Series nozzles consist of a nozzle body and a spray set-up
- A wide variety of spray set-ups are available with flow rates up to 26 gph (98 lph) and various spray patterns
- Nozzle bodies have liquid and air inlets on opposing sides
- Flat spray set-ups can be easily aligned in 45° increments
- QMJML nozzle bodies include mounting lugs for easy installation
- Kynar® construction with Viton® O-rings



**OVERVIEW: VARIABLE SPRAY NOZZLE SERIES**

- Variable spray nozzles provide uniform spray distribution, even when spraying viscous liquids
- Independent control of liquid, atomizing air and fan air pressures make it possible to fine-tune flow rate, drop size, spray distribution and coverage
- The air atomizing line can be adjusted to vary spray drop size without affecting liquid flow rates
- Additional liquid inlet/outlet port allows for recirculation that effectively maintains the flow of viscous liquids

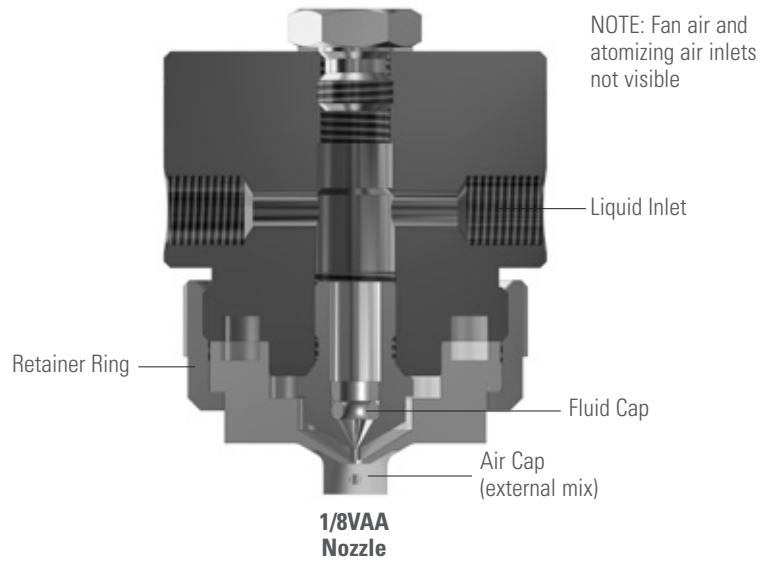

Independent control of liquid, fan air and atomizing air provides maximum control of spray performance.

**QUICK REFERENCE GUIDE**

Product Number	Inlet Connection Size (in.)	Max Flow	Max Temp (liquid)	Spray Set-Ups
<b>VAA Series</b>	1/8 (F) NPT or BSPT atomizing air, fan air and liquid	49.8 gph (189 lph)	200°F (93°C)	SUV set-ups (pages D62) 

**PLACING YOUR ORDER**

Call **1.800.95.SPRAY** for application assistance or to place an order.

**FOR DETAILED SPRAY SET-UP PERFORMANCE DATA  
SEE SECTION D**

VARIABLE SPRAY NOZZLE OPTIONS

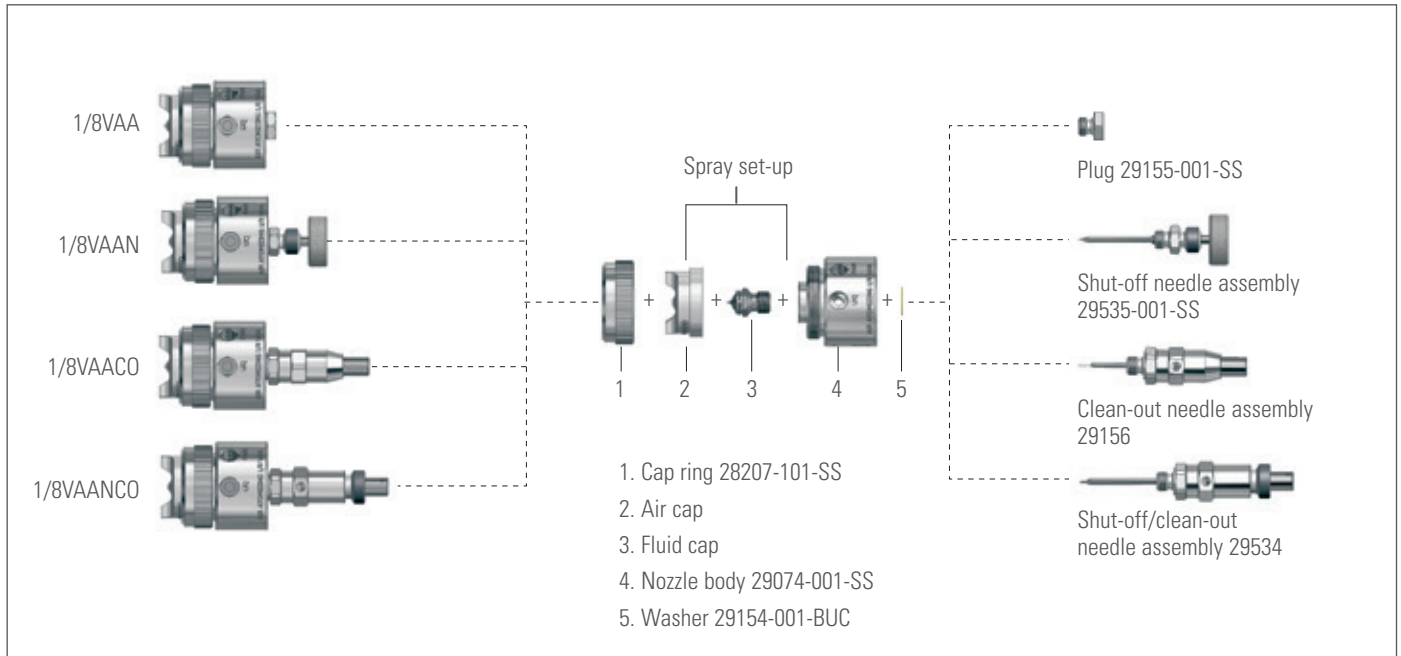

**1/8VAA SERIES NOZZLES**

- Flow rates up to 49.8 gph (189 lph)
- Stainless steel construction
- With fan air in operation, a flat spray pattern is produced; a round spray pattern is produced when fan air is off
- Atomizing air line can be adjusted to vary spray drop size without affecting flow rate
- Dual liquid inlets allow recirculating of sprayed fluid
- Anti-bearding spray set-ups are available



1/8VAA Nozzle

**1/8VAA NOZZLE OPTIONS**

 <p><b>1/8VAAN</b> – Manual shut-off needle to stop liquid flow</p>	 <p><b>1/8VAACO</b> – Manual clean-out needle to clear obstructions from the fluid orifice</p>	 <p><b>1/8VAANCO</b> – Combination shut-off/clean-out needle direction</p>
--	---	--

**OVERVIEW: HIGH EFFICIENCY SPRAY NOZZLE SERIES**

- A patented three-stage atomization process produces relatively high liquid flows with very small drops using low air consumption
- Tight droplet size control for critical spray applications
- Significantly higher turndown ratios than standard air atomizing nozzles for maximum operating flexibility
- Large free passages reduce the risk of clogging
- Available with threaded inlet connections or mounted on standard or made-to-order spray injectors
- Ideal for gas cooling and conditioning applications
- Use with lance and injector spray systems

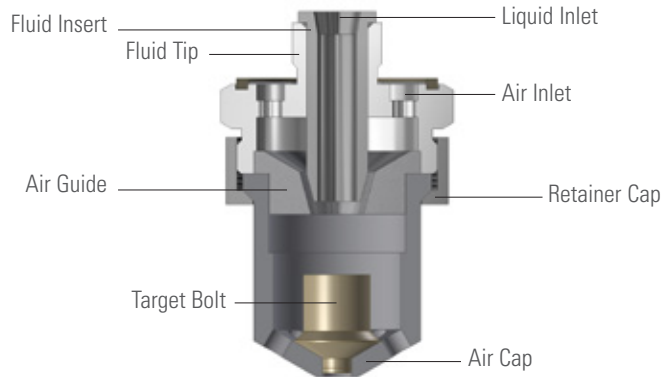

**FMA FloMax® Nozzle**

Air and liquid converge, allowing high velocity air to shear the liquid. The liquid/air mixture then impacts the target bolt forcing additional mechanical breakup. As the mixture exits the orifices of the air cap, the additional pressure drop further atomizes the liquid.

**QUICK REFERENCE GUIDE**

Product Number	Max Flow	Materials
<b>FloMax X Series</b>	1.5 gpm (5.67 lpm)	310 and 316 stainless steel, Hastelloy® Other materials available upon request
<b>FloMax A Series</b>	45 gpm (170 lpm)	Nozzle materials include 310 and 316 stainless and Hastelloy Air cap materials include reaction-bonded silicon carbide, Stellite®, ceramic and tungsten carbide

**HIGH EFFICIENCY SPRAY NOZZLE SERIES OPTIONS**

**FloMax X Series**

- Flow rates up to 1.5 gpm (5.67 lpm)
- Spray angles of 20°, 55° and 90°
- Stainless steel or Hastelloy construction. Other materials available upon request



**FloMax A Series**

- Flow rates up to 45 gpm (171.3 lpm)
- Spray angles of 20° and 55°
- Stainless steel or Hastelloy construction. Other materials available upon request
- Anti-bearding design available to reduce maintenance in high-particulate spraying applications



**PLACING YOUR ORDER**

**Call 1.800.95.SPRAY for application assistance or to place an order.**



## AUTOMATIC SPRAY NOZZLES

COATING • DISPENSING • GLAZING  
LAMINATING • ROBOTIC APPLICATIONS  
MARKING • FLAVORING • HUMIDIFYING  
LUBRICATING • MOISTURIZING

# AUTOMATIC NOZZLES INTRODUCTION



## PRECISE CONTROL & EFFICIENT SPRAY APPLICATION

### INTRODUCTION

If your application requires precise control of intermittent spraying, you'll find dozens of product options in this section. Both electrically-actuated and air-actuated nozzles are available. Models which atomize flow using liquid pressure only or using compressed air are both offered. More information about the spray performance of the hydraulic spray tips and air atomizing set-ups used in these nozzles is found in Section D. To optimize the performance of automatic spray nozzles, consider adding an AutoJet® Spray Controller.

### THE BENEFITS OF SPRAY CONTROL

Automated spray control can help increase production, improve accuracy, reduce waste and overspray and allow workers to be deployed to other tasks.

More specifically, with AutoJet Spray Control you can:

- Adjust flow rate for line speed variations
- Fine-tune timing to accurately spray moving targets and prevent dripping on nozzle actuation or shut-off
- Precisely control liquid pressure, atomizing air pressure and fan air pressure to optimize spray performance
- Notify operators or shut down on specified faults
- Integrate control of your spray application with existing plant control

**AutoJet**<sup>®</sup>  
TECHNOLOGIES  
From *Spraying Systems Co.*

FOR MORE INFORMATION ON AUTOJET SPRAY  
CONTROLLERS SEE PAGES C4 & C5









# AUTOMATIC NOZZLES TABLE OF CONTENTS





## PRECISION SPRAY CONTROL

 Overview	PAGE C4
---	------------





## ELECTRICALLY-ACTUATED SPRAY NOZZLES: HYDRAULIC

 Quick Reference Guide	PAGE C7
 PulsaJet® Series	C7
 Quick Reference Guide	C9
 AA250AUH Nozzles and AA26AUH Nozzles	C9







## ELECTRICALLY-ACTUATED SPRAY NOZZLES: AIR ATOMIZING

 Quick Reference Guide	PAGE C10
 PulsaJet Series	C11
 AA28JJAU Nozzles	C11
 AA29JAUCO Nozzles	C11

## AIR-ACTUATED SPRAY NOZZLES: HYDRAULIC

 Quick Reference Guide	PAGE C12
 JUAUH and JJAUH Series	C13
 D55500-JAUH Series	C13
 AA22AUH Series	C13
 AA24AUA Series	C14

## AIR-ACTUATED SPRAY NOZZLES: AIR ATOMIZING

 Quick Reference Guide	PAGE C15
 JUAU Series	C16
 JJAU Series	C17
 VX Variable Spray Series	C18
 VAU/VMAU Variable Spray Series	C18
 10530 Series	C18
 72100 Nozzles	C18
 D55500-JAU/JAUCO Series	C18

## OPTIMIZE PERFORMANCE WITH:



AutoJet® Spray Controllers provide control ranging from simple on/off to sophisticated closed-loop to optimize the performance of automatic nozzles. See page C4



A variety of spray manifolds are available to save installation time and ensure proper nozzle positioning. See page F1



Premium UniJet® tips are available for select automatic nozzles and provide even coverage and better spray distribution. See page D5

# PRECISION SPRAY CONTROL O V E R V I E W

## EXPERIENCE BETTER PRECISION & INCREASED AUTOMATION



### AUTOJET® SPRAY CONTROLLERS

All of our automatic spray nozzles are compatible with our spray controllers. For operations like coating, lubricating, moisturizing and adding costly ingredients, spray control can dramatically improve product or process quality and help save tens of thousands of dollars annually.

If your operation requires any of the following, the spray control should be considered.

- Consistent, uniform coverage of the target
- Precise spray placement on the target
- Intermittent spraying
- The use of costly coatings or chemicals
- The ability to adjust spray performance based on line speed
- Monitoring and supervision to ensure proper spray performance

Our AutoJet Spray Controllers range from basic to advanced.

- AutoJet Model 1750+ Modular Spray System with basic on/off spray control for up to 10 automatic nozzles
- AutoJet Model 2150+ Spray Control Panel provides timing and sensor control for up to 16 nozzles
- AutoJet Model 2850+ Spray Control Panel with sophisticated real-time monitoring and closed-loop control for up to 32 nozzles

Many systems include a spray manifold to ensure proper delivery of the fluid to the nozzle, maintain optimal nozzle positioning and organize tubing to simplify maintenance. We have a wide variety of styles available.

Consult with your local sales engineer to determine which manifold is compatible with the nozzles in your spray system.

FOR A FULL LIST OF SPRAY MANIFOLDS  
SEE PAGE F4





## PRECISION SPRAY CONTROL (PSC)

PulsaJet® automatic spray nozzles paired with an AutoJet® spray controller provide Precision Spray Control (PSC) to ensure coatings are applied uniformly and with minimal waste.

The benefits of PSC are many:

- Automatically maintains consistent coating weight even when line speed changes
- Reduces product scrap caused by over- or under-application of the sprayed solution
- Reduces the use of costly coatings by applying the proper coating volume directly on the target
- Eliminates maintenance time to clean overspray from equipment and/or floor due to over-application
- Improves worker safety by minimizing misting
- Eliminates the need for compressed air in some applications

## HOW PRECISION SPRAY CONTROL WORKS

Electrically-actuated spray nozzles are turned on and off very quickly to control flow rate. This cycling is so fast that the flow often appears to be constant.

With traditional nozzles, flow rate adjustments require a change in pressure. Changing pressure also changes the nozzle's spray angle/coverage and drop size. With PSC, pressure remains constant enabling flow rate changes without changes in spray performance.

### NOZZLES SPRAYING 90% OF THE TIME



### NOZZLES SPRAYING 50% OF THE TIME



### NOZZLES SPRAYING 25% OF THE TIME



## TYPICAL APPLICATIONS:

- Adhesives/glue
- Anti-foaming agents
- Ascorbic acid
- De-ionized water
- Detergents
- Dyes and inks
- Emulsions
- Enzymes
- Fire retardants
- Fragrances/aromas
- Gels
- Lotions
- Lubricants/release agents/silicone
- Oils
- Wax

LEARN MORE & SEE HOW PSC WORKS:  
[spray.com/psc](http://spray.com/psc)

## OVERVIEW: ELECTRICALLY-ACTUATED HYDRAULIC NOZZLES

- Hydraulic atomizing nozzles use only liquid pressure as the force for atomization
- Electrically-actuated nozzles provide the fastest cycling of any automatic nozzles – up to 25,000 cycles per minute
- When using a PulsaJet® series nozzle and an AutoJet® spray controller, Precision Spray Control (PSC) can provide:
  - Consistent application rates at varying line speeds
  - Low flow rates comparable to air atomizing nozzles eliminating the use of compressed air in some applications
- Options for the PulsaJet 10000 series nozzles include food-grade materials of construction, sanitary connections, liquid recirculation and temperature control for spraying viscous liquids
- Dozens of UniJet® spray tips are available for PulsaJet nozzles in a wide variety of flow rates. Spray tip alignment is offered on some models
- Other electrically-actuated hydraulic nozzles include versions with a removable fluid module for easy maintenance and compact versions with stainless steel and Ryton® construction for maximum chemical resistance

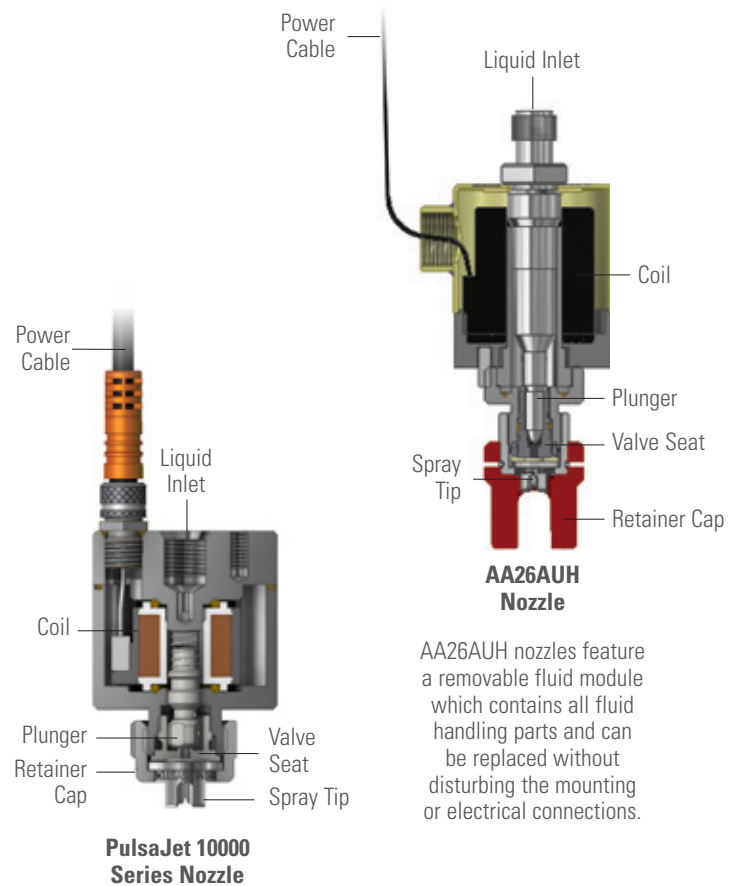

The compact design and simple mounting options for PulsaJet nozzles enable them to be easily integrated into most production areas. Wear parts for all PulsaJet nozzles are easily accessible to minimize routine maintenance time.

AA26AUH nozzles feature a removable fluid module which contains all fluid handling parts and can be replaced without disturbing the mounting or electrical connections.

### PLACING YOUR ORDER

Call 1.800.95.SPRAY for application assistance or to place an order.

FOR DETAILED SPRAY TIP PERFORMANCE DATA  
SEE SECTION D

## QUICK REFERENCE GUIDE – ELECTRICALLY-ACTUATED HYDRAULIC PULSAJET® SERIES

PulsaJet Series	Connection Size (in.)	Max Liquid Pressure	Power	Max Flow	Max Temp (liquid)	Max Speed	Spray Tips
<b>AA10000AUH-03</b>	1/8 NPT or BSPT	100 psi (7 bar)* 250 psi (17 bar) (250 w/ advanced AutoJet® spray controller)	24 VDC, (0.36 Amp)	0.47 gpm (1.8 lpm)	200°F (93°C)	10,000 cpm (15,000 cpm with advanced AutoJet controller)	TPU (page D6)
<b>AA10000AUH-03-Z1</b>	1/8 (F) NPT or BSPT	100 psi (7 bar)	24 VDC, (0.36 Amp)	0.47 gpm (1.8 lpm)	104°F (40°C)	10,000 cpm	TPU (page D6)
<b>AA10000AUH-10</b>	1/4 (F) NPT or BSPT	100 psi (7 bar)	24 VDC, (1.05 Amp)	1.6 gpm (6.1 lpm)	150°F (66°C)	5,000 cpm	TPU (page D6)
<b>AA10000AUH-104210</b>	1/8 (F) NPT or BSPT	100 psi (7 bar) 250 psi (17 bar) (250 w/ advanced AutoJet spray controller)	24 VDC, (0.36 Amp)	0.47 gpm (1.8 lpm)	200CF (93°C)	10,000 cpm (15,000 cpm with advanced AutoJet controller)	PWMD w/ auto spray pattern alignment (page D12)
<b>AA10000-10-PWMD</b>	1/4 (F) NPT or BSPT	100 psi (7 bar)	24 VDC, (1.05 Amp)	1.6 gpm (6.1 lpm)	150°F (66°C)	5,000 cpm	PWMD w/ auto spray pattern alignment (page D12)
<b>AA10000AUH-104215</b>	1/8 (F) NPT or BSPT	100 psi (7 bar)	24 VDC, (0.36 Amp)	0.47 gpm (1.8 lpm)	200°F (93°C)	10,000 cpm (15,000 cpm with advanced AutoJet controller)	PWMD w/ auto spray pattern alignment (page D12)
<b>AA10000AUH-72440-1/4</b>	1/4 (F) NPT or BSPT	100 psi (7 bar)* 250 psi (17 bar) (250 w/ advanced AutoJet spray controller)	48 VDC, (0.36 Amp)	0.47 gpm (1.8 lpm)	150°F (66°C)	10,000 cpm (15,000 cpm with advanced AutoJet controller)	TPU (page D6)
<b>AA10000AUH-0050</b>	5/32 (4mm) tube fittings	200 psi (14 bar)	48 VDC, (1.0 Amp)	0.08 gpm (0.30 lpm)	150°F (66°C)	25,000 cpm	PWMM w/ auto spray alignment pattern (page D13)

\*Higher pressure possible with AutoJet® advanced spray controllers

## ELECTRICALLY-ACTUATED HYDRAULIC PULSAJET® NOZZLE OPTIONS

**AA10000AUH-03**

- Typical flow range: 0.0017 - 0.47 gpm (0.006 - 1.8 lpm)
- Construction: Stainless steel, Viton® or EPDM seals, PPS and zirconia ceramic

**AA10000AUH-03-Z1**

- For use in Zone 1 hazardous areas
- Typical flow range: 0.0017 - 0.47 gpm (0.006 - 1.8 lpm)
- Construction: Stainless steel, FFKM seals, PPS and PEEK



## ELECTRICALLY-ACTUATED HYDRAULIC PULSAJET® NOZZLE OPTIONS

**AA10000AUH-10**

- Typical flow range: 0.02 - 1.6 gpm (0.075 - 6.1 lpm)
- Construction: Stainless steel, Viton® or EPDM seals, PPS and PEEK

**AA10000AUH-104210**

- Uses UniJet® PWMD self-aligning spray tips which reduce installation/replacement time
- Typical flow range: 0.0017 - 0.47 gpm (0.006 - 1.8 lpm)
- Construction: Stainless steel, Viton or EPDM seals, PPS and zirconia ceramic

**AA10000-10-PWMD**

- Uses UniJet PWMD self-aligning spray tips which reduce installation/replacement time
- Typical flow range: 0.0017 - 1.6 gpm (0.006 - 6.1 lpm)
- Construction: Stainless steel, Viton or EPDM seals, PPS and zirconia ceramic

**AA10000AUH-104215**

- Front port for liquid recirculation
- Typical flow range: 0.0017 - 0.47 gpm (0.006 - 1.8 lpm)
- Construction: Stainless steel, Viton or EPDM seals, PPS and zirconia ceramic

**AA10000AUH-72440-1/4**

- Jacketed design keeps nozzle and sprayed liquid at a consistent temperature
- Typical flow range: 0.0017 - 0.47 gpm (0.006 - 1.8 lpm)
- Construction: Electropolished or chromium nitride coated magnetic stainless steel, stainless steel, Viton or EPDM seals, PPS and zirconia ceramic

**AA10000AUH-0050**

- Miniature design for applications with limited space
- Typical flow range: 0.0009 - 0.08 gpm (0.003 - 0.30 lpm)
- Construction: Stainless steel, Viton or EPDM seals, PPS and PEEK
- Available only as a part of the PulsaJet® Mini Low Flow Spray System (with AutoJet® spray controller)



## QUICK REFERENCE GUIDE – OTHER ELECTRICALLY-ACTUATED HYDRAULIC NOZZLES

Other Electrically-Actuated Hydraulic Nozzles	Connection Size (in.)	Max Liquid Pressure	Power	Max Flow	Max Temp (liquid)	Max Speed	Spray Tips
<b>AA250AUH</b>	1/8 (F) NPT or BSPT	100 psi (7 bar)	24 VDC, (.375 Amp)	0.47 gpm (1.8 lpm)	150°F (66°C)	5000 cpm	TPU (page D6)
<b>AA26AUH, AA26AUH-24200-2-1/2</b>	1/4 (M) NPT or BSPT	2000 psi (138 bar)	24 VDC, (1.65 Amp)	1.1 gpm (4.2 lpm)	200°F (93°C)	1500 cpm	TPU (page D6)

## OTHER ELECTRICALLY-ACTUATED HYDRAULIC NOZZLE OPTIONS

**AA250AUH**

- Flow rates up to 0.47 gpm (1.8 lpm)
- Accurate spray placement in high-speed or low-capacity operations
- Compact, lightweight design
- CE-certified
- Built-in mounting bracket accepts #8-32 UNC or M4 threaded screws
- Construction: Ryton® and stainless steel with Viton® seals for maximum corrosion resistance

**AA26AUH**

- Flow rates up to 1.1 gpm (4.2 lpm)
- High-speed, high-pressure operation
- Fluid module with all fluid handling parts can be replaced without disturbing the mounting or electrical connections
- 24200 version provides 2-1/2" (63.5 mm) extension for coating interiors of products like cans
- Corrosion-resistant – wetted parts are stainless steel or tungsten carbide

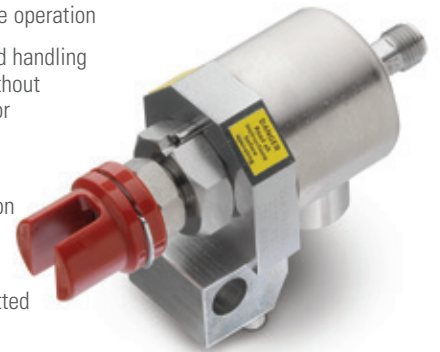
**PLACING YOUR ORDER**

Call 1.800.95.SPRAY for application assistance or to place an order.

FOR DETAILED SPRAY TIP PERFORMANCE DATA  
SEE SECTION D

**OVERVIEW: ELECTRICALLY-ACTUATED AIR ATOMIZING NOZZLES**

- Electrically-actuated nozzles provide the fastest cycling of any automatic nozzles – up to 10,000 cycles per minute
- Compressed air is used as the force for atomization, producing the smallest drop sizes and lowest possible flow rates
- Hundreds of air atomizing set-ups are available for a wide variety of spray patterns and flow rates
- Precision Spray Control using an AutoJet® Spray Controller ensures consistent flow rates at varying line speeds
- Many options are available for convenient mounting, clean-out needles, food grade materials of construction and more

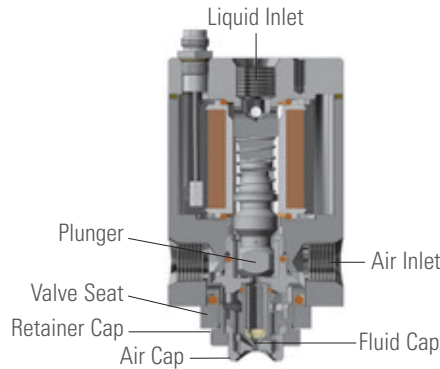

**AA10000JAU Nozzle**

The compact design and simple mounting options for PulsaJet® nozzles enable them to be easily integrated into most production areas. Wear parts for all PulsaJet nozzles are easily accessible to minimize routine maintenance time.

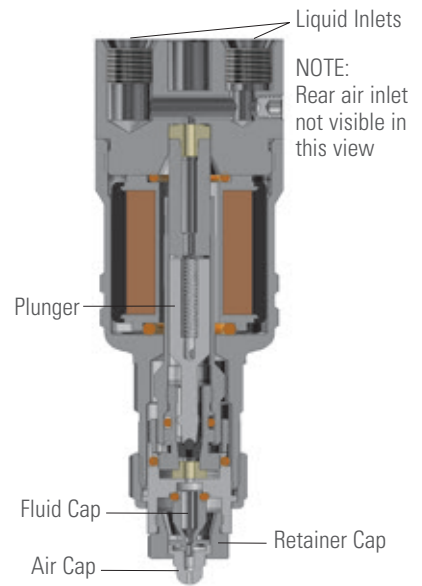

**AA28JJAU Nozzle**

AA28JJAU nozzles feature a removable fluid module which contains all fluid handling parts and can be replaced without disturbing the mounting or electrical connections.

**QUICK REFERENCE GUIDE**

Product Number	Connection Size (in.)	Max Liquid Pressure	Power	Max Air Pressure	Max Flow	Max Temp (liquid)	Max Speed	Spray Set-Ups
<b>AA10000JJAU</b>	1/8 NPT or BSPT (air and liquid)	100 psi (7 bar) 250 psi (17 bar) (w/ advanced AutoJet spray controller)	24 VDC, (0.36 Amp)	100 psi (7 bar)	0.16 gpm (0.61 lpm)	200°F (93°C)	10,000 cpm	JJ set-ups (page D35)
<b>AA10000JAU-10</b>	1/4 NPT or BSPT (air and liquid)	100 psi (7 bar)	24 VDC (1.05 Amp)	100 psi (7 bar)	0.75 gpm (2.84 lpm)	200°F (93°C)	5000 cpm	Threadless 1/4J set-ups (page D24)
<b>AA28JJAU-49815</b>	1/8 NPT (air and liquid)	125 psi (8.6 bar)	24 VDC (0.50 Amp)	100 psi (7 bar)	0.42 gpm (1.62 lpm)	150°F (66°C)	2000 cpm	JJ set-ups (page D35)
<b>AA29JAUCO</b>	1/4 NPT or BSPT (air and liquid)	60 psi (4.0 bar)	24 VDC (0.75 Amp)	100 psi (7 bar)	0.75 gpm (2.84 lpm)	150°F (66°C)	1000 cpm	Threadless 1/4J set-ups (page D24)





## ELECTRICALLY-ACTUATED AIR ATOMIZING PULSAJET® NOZZLE OPTIONS

**AA10000JJAU**

- Rear liquid inlet; side air inlet
- Flow rates up to 0.16 gpm (0.61 lpm)
- Stainless steel, PPS and zirconia ceramic construction with Viton® or EPDM seals
- All wear parts accessible from the front of the nozzle without disturbing mounting and air/liquid/electrical connections
- For use with standard 1/8JJ air caps and 1/8JJ fluid caps (maximum size 2850)

**AA10000JAU-10**

- Rear liquid inlet; side air inlet
- Flow rates up to 0.75 gpm (2.84 lpm)
- Stainless steel, PPS and PEEK construction with Viton or EPDM seals
- All wear parts accessible from the front of the nozzle without disturbing mounting and air/liquid/electrical connections
- For use with standard 1/4J air caps and threadless 1/4J fluid caps (maximum size 80100)



## OTHER ELECTRICALLY-ACTUATED AIR ATOMIZING NOZZLE OPTIONS

**AA28JJAU-49815**

- Flow rates up to 0.42 gpm (1.62 lpm)
- Compact design features rear air and liquid inlets to minimize nozzle profile
- Fluid modules available for in-line, 45° or 75° spray direction
- Stainless steel, carbide and nylon construction with Viton or EPDM seals
- Fluid re-circulation possible
- For use with standard 1/8JJ air caps and 1/8JJ fluid caps (maximum size 2850)

**AA29JAUCO**

- Flow rates up to 0.75 gpm (2.84 lpm)
- Rear air and liquid inlets to minimize nozzle profile
- Additional side liquid inlet available for liquid recirculation
- Stainless steel, PTFE and PPS construction with Viton seals
- Clean-out needle standard for all fluid cap sizes
- For use with standard 1/4J air caps and threadless 1/4J fluid caps (maximum size 80100)

**PLACING YOUR ORDER**

Call 1.800.95.SPRAY for application assistance or to place an order.

FOR DETAILED SPRAY TIP PERFORMANCE DATA  
**SEE SECTION D**

**OVERVIEW: AIR-ACTUATED HYDRAULIC NOZZLES**

- A compressed air inlet on the nozzle body is used to control air cylinder operation for accurate intermittent spraying up to 180 cycles per minute
- Lightweight nozzles use only liquid pressure as the force for atomization
- A variety of nozzle bodies are available for convenient mounting and positioning
- Models are available with extensions and with a recirculating option to optimize performance
- UniJet® spray tips provide a wide variety of spray patterns and flow rates at liquid pressures up to 4000 psi (275 bar)

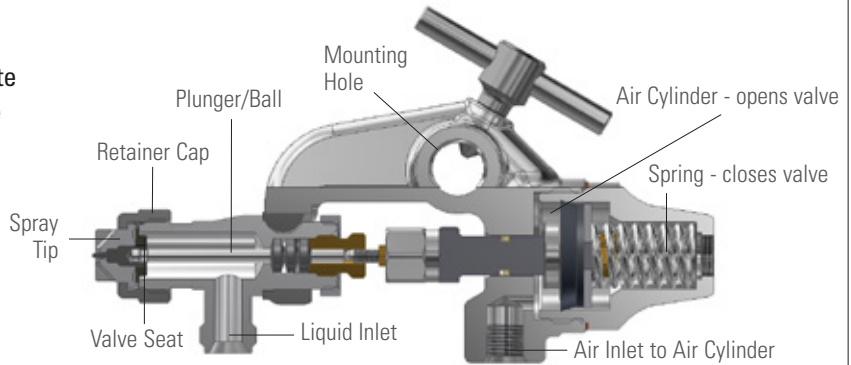

AA22AUH Nozzle

AA22AUH nozzles provide controlled intermittent liquid spray using only hydraulic pressure as the force for atomization. An internal air cylinder automatically interrupts the liquid flow at any desired frequency up to 180 cycles per minute.

**QUICK REFERENCE GUIDE**

Product Number	Inlet Connection Size (in.)	Max Liquid Pressure	Min Air Cylinder Pressure	Max Flow	Max Temp (liquid)	Max Speed	Spray Tips
<b>JAUAH</b>	1/4 NPT or BSPT (air and liquid)	125 psi (8.6 bar)	30 psi (2.1 bar)	0.8 gpm (3 lpm)	160°F (71°C)	180 cpm	TPU (page D6)
<b>1/8JJAUH</b>	1/8 NPT or BSPT (air and liquid)	125 psi (8.6 bar)	30 psi (2.1 bar)	0.3 gpm (1.1 lpm)	160°F (71°C)	180 cpm	TPU (page D6)
<b>D55500-JAUH0</b>	1/8 NPT or BSPT (air and liquid)	43 psi (3 bar)	72 psi (5 bar)	0.42 gpm (1.6 lpm)	158°F (70°C)	600 cpm	TPU or PWMD (page D6 & D13)
<b>D55500-JAUH1</b>	1/8 NPT or BSPT (air and liquid)	145 psi (10 bar)	72 psi (5 bar)	1.5 gpm (5.5 lpm)	158°F (70°C)	300 cpm	TPU or PWMD (page D6 & D13)
<b>AA22AUH</b>	1/8 NPT or BSPT (air) 1/4 NPS or BSPP (liquid)	600 psi (40 bar)	45 psi (3.1 bar)	5 gpm (18.9 lpm)	160°F (71°C)	180 cpm	TPU (page D6)
<b>AA22AUH-7676</b>	1/8 NPT or BSPT (air) 1/4 NPS or BSPP (liquid)	250 psi (17 bar)	45 psi (3.1 bar)	2 gpm (7.6 lpm)	160°F (71°C)	180 cpm	TPU (page D6)
<b>AA22AUH-SS-11024</b>	1/8 NPT or BSPT (air) 1/4 NPS or BSPP (liquid)	600 psi (40 bar)	45 psi (3.1 bar)	5 gpm (18.9 lpm)	160°F (71°C)	180 cpm	TPU (page D6)
<b>AA24AUA</b>	1/8 NPT or BPST (air) 1/4 NPS or BSPP (liquid)	4000 psi (275 bar)	75 psi (5.2 bar)	0.6 gpm (2.3 lpm)	160°F (71°C)	180 cpm	TP-TC (page D14)
<b>AA24AUA-20190</b>	1/8 NPT or BPST (air) 1/4 NPS or BSPP (liquid)	3000 psi (206 bar)	42 psi (2.9 bar)	0.6 gpm (2.3 lpm)	160°F (71°C)	180 cpm	TP-TC (page D14)
<b>AA24AUA-8395</b>	1/8 NPT or BPST (air) 1/4 NPS or BSPP (liquid)	4000 psi (275 bar)	75 psi (5.2 bar)	0.6 gpm (2.3 lpm)	160°F (71°C)	180 cpm	TP-TC (page D14)
<b>AA24AUA-8980</b>	1/8 NPT or BPST (air) 1/4 NPS or BSPP (liquid)	4000 psi (275 bar)	75 psi (5.2 bar)	0.6 gpm (2.3 lpm)	160°F (71°C)	180 cpm	TP-TC (page D14)



AIR-ACTUATED HYDRAULIC NOZZLE OPTIONS

**JUAUH**

- Compact design – 4.5" (114 mm) total length, 1.25 lbs. (0.57 kg) weight (approx.)
- Flow rates up to 0.8 gpm (3.0 lpm)
- Stainless steel or nickel-plated brass construction



**1/8JUAUH**

- Extra compact design – 2.75" (70 mm) total length, 6.5 oz. (184 g) weight (approx.)
- Flow rates up to 0.3 gpm (1.1 lpm)
- Construction: Stainless steel or nickel-plated brass



**D55500-JAUHO**

- Block design 30% smaller than standard 1/4JUAUH
- Flow rates up to 0.42 gpm (1.6 lpm)
- Stainless steel construction with Viton® or EPDM seals
- Available with automatic spray tip alignment (15° or 30° offset angle)
- Available with plate mount and wall mount options



**D55500-JAUH1**

- Block design 30% smaller than standard 1/4JUAUH
- Flow rates up to 1.5 gpm (5.5 lpm)
- Stainless steel construction with Viton or EPDM seals
- Available with automatic spray tip alignment (15° or 30° offset angle)
- Available with plate mount and wall mount options



**AA22AUH**

- Flow rates up to 5 gpm (18.9 lpm)
- Nickel-plated brass or stainless steel construction with PTFE packing material
- Mounting hole with locking screw for easy rod mounting



**MORE OPTIONS**

**AA22AUH-7676** – Same as AA22AUH with flow rates up to 2 gpm (7.6 lpm) and available with extensions up to 36" (914 mm)

**PLACING YOUR ORDER**

Call 1.800.95.SPRAY for application assistance or to place an order.

FOR DETAILED SPRAY TIP PERFORMANCE DATA  
**SEE SECTION D**

## AIR-ACTUATED HYDRAULIC NOZZLE OPTIONS

**AA22AUH-SS-11024**

- Flow rates up to 5 gpm (18.9 lpm)
- Nickel-plated brass or stainless steel construction with PTFE packing material
- Mounting hole with locking screw for easy rod mounting
- Dual liquid inlets allow continuous liquid recirculation

**AA22AUH-SS-14799**

- Flow rates up to 2 gpm (7.6 lpm)
- Nickel-plated brass or stainless steel construction with PTFE packing material
- Mounting hole with locking screw for easy rod mounting
- Adjusting screw limits stroke length of shut-off needle for greater control of response time
- Specially designed for glue and other viscous spray applications

**AA24AUA**

- Flow rates up to 0.6 gpm (2.3 lpm)
- Nickel-plated brass or stainless steel construction with PTFE packing material
- Mounting hole with locking screw for easy rod mounting
- Rear knob locks the shut-off needle in place to prevent accidental discharge while changing spray tips
- Liquid inlet available in the standard "down" position or one of seven other positions in 45° increments

**AA24AUA-20190**

- Flow rates up to 0.6 gpm (2.3 lpm)
- Nickel-plated brass or stainless steel construction with PTFE packing material
- Mounting hole with locking screw for easy rod mounting
- Rear knob locks the shut-off needle in place to prevent accidental discharge while changing spray tips
- Aluminum body reduces total weight to just 1.25 lbs. (0.57 kg)

**AA24AUA-8395**

- Flow rates up to 0.6 gpm (2.3 lpm)
- Nickel-plated brass or stainless steel construction with PTFE packing material
- Mounting hole with locking screw for easy rod mounting
- Rear knob locks the shut-off needle in place to prevent accidental discharge while changing spray tips
- Dual liquid inlets allow continuous liquid recirculation

**AA24AUA-8980**

- Flow rates up to 0.6 gpm (2.3 lpm)
- Nickel-plated brass or stainless steel construction with PTFE packing material
- Mounting hole with locking screw for easy rod mounting
- Rear knob locks the shut-off needle in place to prevent accidental discharge while changing spray tips
- Available with extensions up to 36" (914 mm) long

**PLACING YOUR ORDER**

Call 1.800.95.SPRAY for application assistance or to place an order.

FOR DETAILED SPRAY TIP PERFORMANCE DATA  
**SEE SECTION D**

**OVERVIEW: AIR-ACTUATED AIR ATOMIZING NOZZLES**

- Compressed air is used to control air cylinder operation for accurate intermittent spraying (up to 180 cycles per minute) and also for liquid atomization
- Wide variety of nozzle bodies is available for convenient mounting and positioning
- Models available with clean-out needles, shut-off needles, swivels and strainers to optimize performance
- Liquid lines can be pressure-fed, siphon-fed or gravity-fed
- Spray set-ups, consisting of an air cap and a fluid cap can mix the fluids either internally or externally to produce a fine spray pattern
- Dozens of Drip Free™ air atomizing spray set-ups available for a wide range of flow capacity and spray patterns

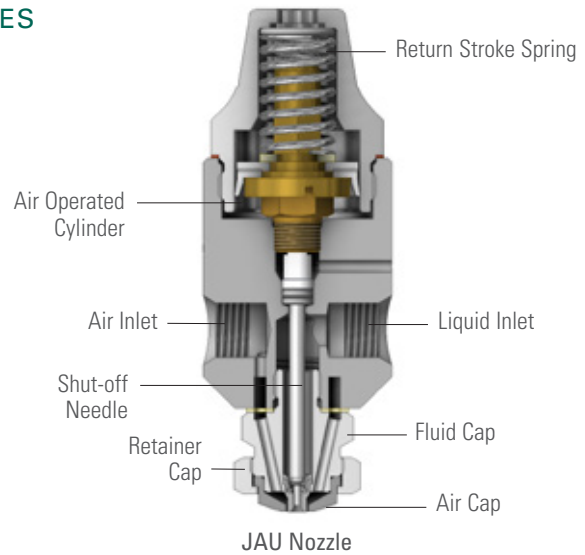

JAU Nozzle  
JAU air atomizing nozzles mix compressed air and liquid to form a finely atomized spray. An air-actuated internal cylinder with a return stroke spring cycles the nozzle up to 180 times per minute.

**QUICK REFERENCE GUIDE**

Product Number	Inlet Connection Size (in.)	Max Liquid Pressure	Min Air Cylinder Pressure	Max Flow	Max Temp (liquid)	Max Speed	Spray Set-Ups
<b>JAU</b>	1/4 NPT or BSPT (air and liquid)	125 psi (8.6 bar)	30 psi (2.1 bar)	1.2 gpm (4.5 lpm)	160°F (71°C)	180 cpm	1/4J set-ups (page D24)
<b>1/8JAU</b>	1/8 NPT or BSPT (air and liquid)	125 psi (8.6 bar)	30 psi (2.1 bar)	0.55 gpm (2.1 lpm)	160°F (71°C)	180 cpm	1/8JJ set-ups (page D35)
<b>VX-70</b>	1/4 NPT or BSPT (air, fan air and liquid)	100 psi (7 bar)	45 psi (3 bar)	1.3 gpm (4.9 lpm)	180° F (82° C)	250 cpm	VX set-ups (pages D66)
<b>VX-72</b>	1/4 NPT or BSPT (air, fan air and liquid)	100 psi (7 bar)	45 psi (3 bar)	1.3 gpm (4.9 lpm)	180° F (82° C)	250 cpm	VX set-ups (pages D66)
<b>VX-80</b>	1/4 NPT or BSPT (air, fan air and liquid)	100 psi (7 bar)	45 psi (3 bar)	1.3 gpm (4.9 lpm)	180° F (82° C)	250 cpm	VX set-ups (pages D66)
<b>VX-82</b>	1/4 NPT or BSPT (air, fan air and liquid)	100 psi (7 bar)	45 psi (3 bar)	1.3 gpm (4.9 lpm)	180° F (82° C)	250 cpm	VX set-ups (pages D66)
<b>1/8VAU</b>	1/8 NPT or BSPT (atom. air, fan air and liquid)	90 psi (6.2 bar)	35 psi (2.4 bar)	0.83 gpm (3.15 lpm)	200°F (93°C)	180 cpm	SUV set-ups (page D62)
<b>1/4VMAU</b>	1/4 NPT or BSPT, or sanitary flange (atom. air, fan air and liquid)	90 psi (6.2 bar)	35 psi (2.4 bar)	1.22 gpm (4.62 lpm)	200°F (93°C)	180 cpm	SUVM set-ups (page D59)
<b>10535-1/4J</b>	1/4 NPT or BSPT (air and liquid)	125 psi (8.6 bar)	30 psi (2.1 bar)	1.2 gpm (4.5 lpm)	400°F (204°C) liquid 150°F (66°C) air	180 cpm	1/4J set-ups (page D24)
<b>10536-1/2J</b>	1/2 NPT or BSPT (air and liquid)	125 psi (8.6 bar)	30 psi (2.1 bar)	5.1 gpm (19.3 lpm)	400°F (204°C) liquid 150°F (66°C) air	180 cpm	1/2J set-ups (page D43)
<b>D55500-JAU</b>	1/8 NPT or BSPT (air and liquid)	43 psi (3 bar)	72 psi (5 bar)	0.42 gpm (1.6 lpm)	158°F (70°C)	600 cpm	1/4J or DSU set-ups (page D24 & D34)
<b>D55500-JAUCO</b>	1/8 NPT or BSPT (air and liquid)	58 psi (4 bar)	72 psi (5 bar)	0.42 gpm (1.6 lpm)	158°F (70°C)	300 cpm	1/4J or DSU set-ups (page D24 & D34)

### JAUA SERIES NOZZLES

- Flow rates up to 1.2 gpm (4.5 lpm)
- Drip Free™ set-ups provide complete shut-off
- Nickel-plated brass or stainless steel construction



JAUA  
Nozzle

### JAUA NOZZLE OPTIONS



**JAUACO** – Clean-out needle operates with every spray cycle to reduce clogging



**JAUAN** – Knurled head screw control permits manual nozzle shut-off without disturbing operation of other nozzles on a manifold



**JAUAD** – Single air inlet for cylinder and atomizing air



**JAUADN** – Single air inlet for cylinder and atomizing air. Includes manual shut-off assembly to temporarily block liquid flow



**JAUAPM** – Plate-mounted nozzle with all inlet connections at the rear of the mounting plate



**JAUAMCO** – Metering knob provides precise adjustment of liquid flow in 5% increments from zero to 100%

### MORE OPTIONS

**JAUAPMCO** – Combines clean-out needle for reduced clogging with convenience of plate-mounting

**1/8JJAU SERIES NOZZLES**

- Compact design ideal where space is limited
- Flow rates up to 0.55 gpm (2.1 lpm)
- Drip Free™ set-ups provide complete shut-off
- Nickel-plated brass or stainless steel construction



**1/8JJAU  
Nozzle**

**1/8JJAU NOZZLE OPTIONS**



**14700-1/8JJAU** – Knurled head screw control permits manual nozzle shut-off without disturbing operation of other nozzles on a manifold



**14675-1/8JJAU** – Single air inlet for cylinder and atomizing air



**16860-1/8JJAU** – Sprays at a 45° angle from nozzle inlet axis



**38499-1/8JJAU** – Uses 1/4J spray set-ups.



**17690-1/8JJAU** – Available with extensions up to 18" (457 mm)



**49660-1/8JJAU** – Available with extensions and either 45° or 90° spray direction from nozzle body

**MORE OPTIONS**

**1/8JJAUMCO** – Metering knob provides precise adjustment of liquid flow in 5% increments from zero to 100%

**16883-1/8JJAU** – Single air inlet for cylinder and atomizing air. Sprays at a 45° angle from nozzle inlet axis

**PLACING YOUR ORDER**

Call 1.800.95.SPRAY for application assistance or to place an order.

FOR DETAILED SPRAY SET-UP PERFORMANCE DATA  
**SEE SECTION D**



## AIR-ACTUATED AIR ATOMIZING NOZZLE OPTIONS

**VX Variable Spray Series**

- Flow rates from 0.013 gpm (.05 lpm) to 1.3 gpm (4.9 lpm)
- Independent control of liquid, atomizing air and fan air
- Pre-set air cap indexing increments ensure repeatability
- Optional metering knobs to simplify manual adjustments to air and liquid volumes
- Integrated anti-bearding technology to resist buildup on the air cap
- Quick release mounting block for fast and easy nozzle change out
- Liquid recirculation reduces clogging
- VX-70 and VX-72 feature stainless steel and anodized aluminum construction
- VX-80 and VX-82 feature 316 stainless steel sanitary nozzles bodies and components in compliance with FDA and EU regulations

**VAU/VMAU Variable Spray Series**

- Flow rates up to 1.22 gpm (4.62 lpm)
- Independent control of liquid, fan air and atomizing air provides maximum control of spray coverage
- Dual liquid inlets allow recirculating of sprayed fluid
- VMAU offers modular construction for reduced maintenance time
- Stainless steel construction

**10535-1/4J**

- Flow rates up to 1.2 gpm (4.5 lpm)
- Self-contained air cylinder provides controlled intermittent spraying
- Drip Free spray set-ups provide complete shut-off
- Nickel-plated brass or stainless steel construction

**10536-1/2J**

- Flow rates up to 5.1 gpm (19.3 lpm)
- Self-contained air cylinder provides controlled intermittent spraying
- Drip Free spray set-ups provide complete shut-off
- Nickel-plated brass or stainless steel construction

**72100-1/8JJAU**

- Smallest automatic air atomizing nozzle available
- Flow rates up to 0.22 gpm (0.83 lpm)
- Less than 1.5" (38 mm) in length; 1.2 oz. (34 g) net weight
- Optional clean-out needle reduces clogging
- Nickel-plated brass or stainless steel construction

**D55500-JAU/JAUCO**

- Block design 30% smaller than standard 1/4JAU
- Flow rates up to 0.42 gpm (1.6 lpm)
- Available with plate mount and wall mount options
- Drip Free™ spray set-ups provide complete shut-off
- Stainless steel construction
- D55500-JAUCO includes clean-out needle to reduce clogging





# SPRAY PERFORMANCE DATA

# SPRAY PERFORMANCE DATA INTRODUCTION



## SPRAY PERFORMANCE TO MEET YOUR APPLICATION NEEDS

The precise application of sprayed liquids is critical to many manufacturing and processing operations. Spray tips and spray set-ups that accurately control the flow rate, spray angle and spray pattern of automatic and air atomizing nozzles are found in this section. UniJet® spray tips are used with hydraulic automatic spray nozzles. An extensive range of air atomizing spray set-ups are also available, for use with both automatic and non-automatic spray nozzles. Spray tips and set-ups are available in a variety of materials. Each part is precision machined or molded for consistent performance.

### OPTIMIZE PERFORMANCE WITH:



Liquid strainers and air filters reduce maintenance and extend nozzle life.  
**See page G4**



Use pressure regulators to maintain consistent air and liquid pressures for consistent results.  
**See page G12**



Drip Free™ spray set-ups ensure positive shut-off for selected air atomizing nozzles with shut-off needles.  
**See page D24-D42**







# SPRAY PERFORMANCE DATA TABLE OF CONTENTS





## UNIJET® HYDRAULIC SPRAY TIPS

	PAGE
 <b>Quick Reference Guide</b>	<b>D4</b>
 <b>For PulsaJet® Series, JUAUH, JJAUH, AA22AUH, AA24AUA, AA26AUH, D55500-JAUH Series</b> (except for 104210, 104214, 104215 and 0050)	
UniJet® TPU Flat Spray Tips	D6
 <b>For PulsaJet 104210, 104214, 104215</b>	
UniJet PWMD Premium Flat Spray Tips	D13
 <b>For PulsaJet 0050</b>	
UniJet PWMM Premium Flat Spray Tips	D13
<b>For JUAUH, JJAUH, AA22AUH, AA24AUA, AA26AUH, D55500-JAUH Series</b>	
 UniJet TP-TC Flat Spray Tips	D14
 UniJet TG, TG-W Full Cone Tips	D18
 UniJet TX Hollow Cone Tips	D19
 UniJet TN Hollow Cone Tips	D20
 UniJet TN-SSTC Hollow Cone Tips	D21



## AIR ATOMIZING SPRAY SET-UPS

	PAGE
 <b>Quick Reference Guide</b>	<b>D22</b>
<b>For Automatic Nozzles: 1/4JAUA, PulsaJet (JAU), AA29JAUCO, 10535 &amp; D55500-JAU Series Nozzles</b> <b>Non-Automatic Nozzles: 1/4J Series</b>	
 Pressure Spray Set-Ups, Internal Mix	D24
 Pressure Spray Set-Ups, External Mix	D30
 Siphon/Gravity Spray Set-Ups, Internal Mix	D32
 Siphon/Gravity Spray Set-Ups, External Mix	D33



### For Automatic Nozzles: 1/8JJAU Series, PulsaJet (JJAU), AA28JJAU Non-Automatic Nozzles: 1/8JJ Series

 Pressure Spray Set-Ups, Internal Mix	D35
 Pressure Spray Set-Ups, External Mix	D39
 Siphon/Gravity Spray Set-Ups, Internal Mix	D41
 Siphon/Gravity Spray Set-Ups, External Mix	D42



### For Automatic Nozzles: 10536 Series Non-Automatic Nozzles: 1/2J Series

 Pressure Spray Set-Ups, Internal Mix	D43
 Pressure Spray Set-Ups, External Mix	D47

### For Non-Automatic Nozzles: 1J Series

 Pressure Spray Set-Ups, Internal Mix	D49
 Pressure Spray Set-Ups, External Mix	D52
 Siphon/Gravity Spray Set-Ups, External Mix	D53

### For Non-Automatic Nozzles: QuickMist® Series

 Pressure Spray Set-Ups, Internal Mix	D54
 Siphon/Gravity Spray Set-Ups, Internal Mix	D57

### For Automatic Nozzles: VMAU, VAU Variable Spray Series Non-Automatic Nozzles: VAA Series Variable Spray Series

 Pressure Spray Set-Ups, External Mix	D59
--	-----

### For Automatic Nozzles: VX Variable Spray Series

 Pressure Spray Set-Ups, External Mix	D64
--	-----

### Numbering System

 Air Caps Set-Ups and Fluid Caps	D70
---	-----

### Air Atomizing Set-Up Compatibility

 Compatibility Charts	D72
--	-----

**OVERVIEW: UNIJET® HYDRAULIC SPRAY TIPS**

- These tips provide hydraulic liquid atomizing for automatic nozzles
- Standard UniJet TPU Series tips available for flat spray patterns
- Tungsten carbide TP UniJet Series tips are used for high pressure spraying
- Premium UniJet PWMD Series and PWMM Series tips provide auto-alignment of flat spray patterns for selected PulsaJet® nozzles
- UniJet TG and TG-W Series tips provide full cone and wide angle spray patterns
- TX and TN Series tips provide hollow cone spray patterns
- TN-SSTC Series tips provide hollow cone spray patterns with fine spray atomization

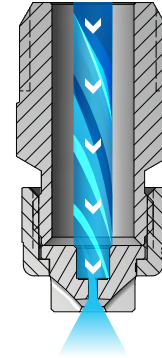

**UniJet Flat Spray Tips**

As the liquid exits through the sharp V shape cut of the orifice, it forms into a flat spray pattern. The distribution is tapered from the center of the spray.

**QUICK REFERENCE GUIDE**

UniJet Tips	Nozzles	Spray Pattern	Spray Angle	Max Pressure (liquid)	Max Flow	Page Number
<b>TPU tips</b>	PulsaJet Series (except for 104210, 104214, 104215 and 0050) JAUH, JJAUH, AA22AUH, AA24AUA, AA26AUH, D55500-JAUH Series	Flat Spray	0° to 110°	500 psi (35 bar)	25 gpm (94 lpm)	D6
<b>PWMD tips</b>	PulsaJet 104210, 104214, 104215	Flat Spray	65° to 110°	100 psi (7 bar)	.47 gpm (1.78 lpm)	D12
<b>PWMM tips</b>	PulsaJet 0050	Flat Spray	0° to 110°	200 psi (14 bar)	.050 gpm (.189 lpm)	D13
<b>TP-TC tips</b>	JAUH, JJAUH, AA22AUH, AA24AUA, AA26AUH, D55500-JAUH Series	Flat Spray	5° to 110°	3000 psi (207 bar)	17.4 gpm (66 lpm)	D14
<b>TG tips</b>	JAUH, JJAUH, AA22AUH, AA24AUA, AA26AUH, D55500-JAUH Series	Full Cone	50° to 67°	150 psi (10 bar)	3.5 gpm (13 lpm)	D18
<b>TG-W tips</b>	JAUH, JJAUH, AA22AUH, AA24AUA, AA26AUH, D55500-JAUH Series	Full Cone Wide Angle	102° to 120°	80 psi (6 bar)	9.1 gpm (34 lpm)	D18
<b>TX tips</b>	JAUH, JJAUH, AA22AUH, AA24AUA, AA26AUH, D55500-JAUH Series	Hollow Cone	40° to 78°	400 psi (28 bar)	82 gpm (310 lpm)	D19
<b>TN tips</b>	JAUH, JJAUH, AA22AUH, AA24AUA, AA26AUH, D55500-JAUH Series	Hollow Cone	35° to 91°	1000 psi (70 bar)	130 gpm (492 lpm)	D20
<b>TN-SSTC tips</b>	JAUH, JJAUH, AA22AUH, AA24AUA, AA26AUH, D55500-JAUH Series	Hollow Cone	–	2000 psi (140 bar)	184 gpm (697 lpm)	D21



## UNIJET® HYDRAULIC SPRAY TIPS OPTIONS

**UniJet® Flat Spray Series**

- Flat spray pattern with tapered edges provides uniform coverage when sprays overlap
- TPU Series for use with a variety of automatic spray nozzles
- TP-TC Series
  - High pressure capability provides higher impact
  - Erosion-resistant tungsten carbide orifice insert provides extended wear life
  - Excellent corrosion resistance
  - Tip orifice insert is recessed in a solid stainless steel tip body to protect against damage
  - For use with high pressure automatic spray nozzles

**Premium UniJet Flat Spray Series**

- Flat spray pattern with tapered edges provides uniform coverage when sprays overlap
- Automatic spray pattern alignment with 5° pattern offset when used with PulsaJet® nozzles
- PWM Series for use with selected PulsaJet® automatic spray nozzles
- PWMM Series for use with PulsaJet® 0050 automatic spray nozzles

**UniJet Full Cone Series**

- TG Series tips provide a full cone spray pattern
- TG-W Series tips provide wide angle full cone spray pattern
- For use with a variety of automatic spray nozzles

**UniJet Hollow Cone Series**

- TX Series and TN Series tips provide a hollow cone spray pattern
- For use with a variety of automatic spray nozzles
- TN-SSTC Series
  - High pressure capability for fine spray atomization
  - Erosion-resistant tungsten carbide orifice insert provides extended wear life
  - Excellent corrosion resistance
  - For use with high pressure automatic spray nozzles

**PLACING YOUR ORDER**

Call **1.800.95.SPRAY** for application assistance  
or to place an order.

**UNIJET® TPU HYDRAULIC FLAT SPRAY TIPS**

FOR PULSAJET® SERIES\*, JUAUH, JJAUH, AA22AUH, AA24AUA, AA26AUH, D55500-JAUH SERIES



**PERFORMANCE DATA:  
UNIJET® TPU HYDRAULIC FLAT SPRAY TIPS**

Spray Angle at 40 psi	Capacity Size	Equiv. Orifice Dia. (in.)	Flow Rate Capacity (gallons per minute)									Spray Angle (°)			
			5 psi	10 psi	20 psi	40 psi	80 psi	100 psi	200 psi	300 psi	500 psi	20 psi	40 psi	80 psi	200 psi
110°	0033	.015	—	—	.023	.033	.047	.052	.07	.09	.12	91	110	116	121
	0050	.018	—	—	.035	.050	.07	.08	.11	.14	.18	91	110	118	124
	0067	.021	—	—	.05	.067	.09	.11	.15	.18	.24	92	110	118	124
	01	.026	.035	.05	.07	.10	.14	.16	.22	.27	.35	94	110	121	124
	015	.032	.05	.08	.11	.15	.21	.24	.34	.41	.53	97	110	121	124
	02	.035	.07	.10	.14	.20	.28	.32	.45	.55	.71	98	110	120	123
	03	.043	.11	.15	.21	.30	.42	.47	.67	.82	1.1	99	110	120	123
	04	.050	.14	.20	.28	.40	.57	.63	.89	1.1	1.4	100	110	119	122
	05	.056	.18	.25	.35	.50	.71	.79	1.1	1.4	1.8	100	110	118	122
	06	.061	.21	.30	.42	.60	.85	.95	1.3	1.6	2.1	101	110	117	122
	07	.066	.25	.35	.49	.70	.99	1.1	1.6	1.9	2.5	102	110	117	121
	08	.071	.28	.40	.57	.80	1.1	1.3	1.8	2.2	2.8	102	110	117	121
	10	.079	.35	.50	.71	1.0	1.4	1.6	2.2	2.7	3.5	103	110	117	119
	12	.087	.42	.60	.85	1.2	1.7	1.9	2.7	3.3	4.2	103	110	117	119
	15	.097	.53	.75	1.1	1.5	2.1	2.4	3.4	4.1	5.3	104	110	117	118
	20	.112	.71	1.0	1.4	2.0	2.8	3.2	4.5	5.5	7.1	105	110	117	118
30	.133	1.1	1.5	2.1	3.0	4.2	4.7	6.7	8.2	10.6	105	110	117	118	
95°	01	.026	.035	.05	.07	.10	.14	.16	.22	.27	.35	81	95	105	113
	015	.032	.05	.08	.11	.15	.21	.24	.34	.41	.53	82	95	105	113
	02	.035	.07	.10	.14	.20	.28	.32	.45	.55	.71	82	95	105	113
	03	.043	.11	.15	.21	.30	.42	.47	.67	.82	1.1	83	95	104	111
	04	.050	.14	.20	.28	.40	.57	.63	.89	1.1	1.4	84	95	103	108
	05	.056	.18	.25	.35	.50	.71	.79	1.1	1.4	1.8	84	95	102	107
	06	.061	.21	.30	.42	.60	.85	.95	1.3	1.6	2.1	86	95	101	106
	07	.066	.25	.35	.49	.70	.99	1.1	1.6	1.9	2.5	86	95	101	106
	08	.071	.28	.40	.57	.80	1.1	1.3	1.8	2.2	2.8	87	95	100	105
	09	.075	.32	.45	.64	.90	1.3	1.4	2.0	2.5	3.2	89	95	100	105
	10	.079	.35	.50	.71	1.0	1.4	1.6	2.2	2.7	3.5	89	95	100	105
	11	.083	.39	.55	.78	1.1	1.6	1.7	2.5	3.0	3.9	89	95	100	105
	12	.087	.42	.60	.85	1.2	1.7	1.9	2.7	3.3	4.2	89	95	100	105
	13	.090	.46	.65	.92	1.3	1.8	2.1	2.9	3.6	4.6	89	95	100	105
	14	.093	.49	.70	.99	1.4	2.0	2.2	3.1	3.8	4.9	89	95	100	105
	15	.097	.53	.75	1.1	1.5	2.1	2.4	3.4	4.1	5.3	90	95	100	105
	16	.100	.57	.80	1.1	1.6	2.3	2.5	3.6	4.4	5.7	90	95	100	105
	18	.106	.64	.90	1.3	1.8	2.5	2.8	4.0	4.9	6.4	90	95	100	105
	20	.112	.71	1.0	1.4	2.0	2.8	3.2	4.5	5.5	7.1	90	95	100	105
	30	.133	1.1	1.5	2.1	3.0	4.2	4.7	6.7	8.2	10.6	91	95	101	105
	40	.153	1.4	2.0	2.8	4.0	5.7	6.3	8.9	11.0	14.1	92	95	100	105
50	.172	1.8	2.5	3.5	5.0	7.1	7.9	11.2	13.7	17.7	93	95	99	103	
60	.188	2.1	3.0	4.2	6.0	8.5	9.5	13.4	16.4	21	93	95	99	103	
70	.203	2.5	3.5	4.9	7.0	9.9	11.1	15.7	19.2	25	93	95	99	103	

Other body types may be available. Contact your sales engineer for further information. **Highlighted column shows the rated pressure of the nozzles.**

\*PulsaJet® Series (except for 104210, 104214, 104215 and 0050)



**PERFORMANCE DATA:  
 UNIJET® TPU HYDRAULIC FLAT SPRAY TIPS**

Spray Angle at 40 psi	Capacity Size	Equiv. Orifice Dia. (in.)	Flow Rate Capacity (gallons per minute)									Spray Angle (°)			
			5 psi	10 psi	20 psi	40 psi	80 psi	100 psi	200 psi	300 psi	500 psi	20 psi	40 psi	80 psi	200 psi
80°	0050	.018	–	–	.035	.050	.07	.08	.11	.14	.18	61	80	95	101
	0067	.021	–	.033	.05	.067	.09	.11	.15	.18	.24	67	80	94	99
	01	.026	–	.05	.07	.10	.14	.16	.22	.27	.35	68	80	89	92
	015	.032	–	.08	.11	.15	.21	.24	.34	.41	.53	68	80	89	92
	02	.035	.07	.10	.14	.20	.28	.32	.45	.55	.71	69	80	88	91
	03	.043	.11	.15	.21	.30	.42	.47	.67	.82	1.1	70	80	87	90
	04	.050	.14	.20	.28	.40	.57	.63	.89	1.1	1.4	71	80	86	89
	045	.053	.16	.23	.32	.45	.64	.71	1.0	1.2	1.6	71	80	86	89
	05	.056	.18	.25	.35	.50	.71	.79	1.1	1.4	1.8	71	80	86	89
	06	.061	.21	.30	.42	.60	.85	.95	1.3	1.6	2.1	72	80	85	88
	07	.066	.25	.35	.49	.70	.99	1.1	1.6	1.9	2.5	72	80	85	88
	08	.071	.28	.40	.57	.80	1.1	1.3	1.8	2.2	2.8	72	80	84	87
	09	.075	.32	.45	.64	.90	1.3	1.4	2.0	2.5	3.2	73	80	84	87
	10	.079	.35	.50	.71	1.0	1.4	1.6	2.2	2.7	3.5	73	80	84	87
	11	.083	.39	.55	.78	1.1	1.6	1.7	2.5	3.0	3.9	73	80	83	86
	12	.087	.42	.60	.85	1.2	1.7	1.9	2.7	3.3	4.2	73	80	83	86
	13	.090	.46	.65	.92	1.3	1.8	2.1	2.9	3.6	4.6	73	80	83	86
	14	.093	.49	.70	.99	1.4	2.0	2.2	3.1	3.8	4.9	73	80	83	86
	15	.097	.53	.75	1.1	1.5	2.1	2.4	3.4	4.1	5.3	74	80	83	86
	16	.100	.57	.80	1.1	1.6	2.3	2.5	3.6	4.4	5.7	74	80	83	86
17	.103	.60	.85	1.2	1.7	2.4	2.7	3.8	4.7	6.0	74	80	83	86	
20	.112	.71	1.0	1.4	2.0	2.8	3.2	4.5	5.5	7.1	74	80	83	86	
25	.121	.88	1.3	1.8	2.5	3.5	4.0	5.6	6.8	8.8	74	80	83	86	
30	.133	1.1	1.5	2.1	3.0	4.2	4.7	6.7	8.2	10.6	74	80	83	86	
40	.153	1.4	2.0	2.8	4.0	5.7	6.3	8.9	11.0	14.1	74	80	83	86	
50	.172	1.8	2.5	3.5	5.0	7.1	7.9	11.2	13.7	17.7	74	80	83	85	
60	.188	2.1	3.0	4.2	6.0	8.5	9.5	13.4	16.4	21	75	80	83	85	
70	.203	2.5	3.5	4.9	7.0	9.9	11.1	15.7	19.2	25	75	80	83	86	
73°	0023	.012	–	–	.016	.023	.032	.036	.051	.063	.081	50	73	89	97
	0039	.016	–	.020	.028	.039	.055	.062	.087	.11	.14	53	73	87	93
	0077	.023	–	.039	.055	.077	.11	.12	.17	.21	.27	53	73	86	92
	0116	.028	.041	.058	.082	.12	.16	.18	.26	.32	.41	54	73	85	90
	0154	.032	.054	.077	.11	.15	.22	.24	.34	.42	.54	55	73	84	88
	0231	.038	.082	.12	.16	.23	.33	.37	.52	.63	.82	56	73	83	87
	0308	.044	.11	.15	.22	.31	.44	.49	.69	.84	1.1	58	73	82	86
	0385	.049	.14	.19	.27	.39	.54	.61	.86	1.1	1.4	59	73	81	85
	0462	.054	.16	.23	.33	.46	.65	.73	1.0	1.3	1.6	60	73	80	84
	0616	.062	.22	.31	.44	.62	.87	.97	1.4	1.7	2.2	63	73	79	83
	0770	.069	.27	.39	.54	.77	1.1	1.2	1.7	2.1	2.7	64	73	77	82
	0924	.076	.33	.46	.65	.92	1.3	1.5	2.1	2.5	3.3	65	73	77	80

Other body types may be available. Contact your sales engineer for further information. **Highlighted column shows the rated pressure of the nozzles.**

\*PulsaJet® Series (except for 104210, 104214, 104215 and 0050)



**UNIJET® TPU HYDRAULIC FLAT SPRAY TIPS**

FOR PULSAJET® SERIES\*, JAUAH, JJAUH, AA22AUH, AA24AUA, AA26AUH, D55500-JAUH SERIES

**PERFORMANCE DATA:  
UNIJET® TPU HYDRAULIC FLAT SPRAY TIPS**

Spray Angle at 40 psi	Capacity Size	Equiv. Orifice Dia. (in.)	Flow Rate Capacity (gallons per minute)									Spray Angle (°)			
			5 psi	10 psi	20 psi	40 psi	80 psi	100 psi	200 psi	300 psi	500 psi	20 psi	40 psi	80 psi	200 psi
65°	0017	.011	–	–	.012	.017	.024	.027	.038	.047	.06	44	65	77	86
	0025	.013	–	–	.018	.025	.035	.040	.06	.07	.09	45	65	77	84
	0033	.015	–	–	.023	.033	.047	.052	.07	.09	.12	47	65	76	83
	0050	.018	–	–	.035	.050	.07	.08	.11	.14	.18	48	65	75	82
	0067	.021	–	.033	.05	.067	.09	.11	.15	.18	.24	50	65	75	81
	01	.026	–	.05	.07	.10	.14	.16	.22	.27	.35	51	65	74	80
	015	.032	–	.08	.11	.15	.21	.24	.34	.41	.53	51	65	74	80
	02	.035	.07	.10	.14	.20	.28	.32	.45	.55	.71	52	65	73	79
	025	.039	.09	.13	.18	.25	.35	.40	.56	.68	.88	52	65	73	79
	03	.043	.11	.15	.21	.30	.42	.47	.67	.82	1.1	53	65	72	78
	035	.047	.12	.18	.25	.35	.49	.55	.78	.96	1.2	53	65	72	78
	04	.050	.14	.20	.28	.40	.57	.63	.89	1.1	1.4	53	65	72	76
	05	.056	.18	.25	.35	.50	.71	.79	1.1	1.4	1.8	53	65	72	76
	055	.059	.19	.28	.39	.55	.78	.87	1.2	1.5	1.9	53	65	72	76
	06	.061	.21	.30	.42	.60	.85	.95	1.3	1.6	2.1	54	65	72	75
	07	.066	.25	.35	.49	.70	.99	1.1	1.6	1.9	2.5	54	65	72	75
	08	.071	.28	.40	.57	.80	1.1	1.3	1.8	2.2	2.8	55	65	71	74
	09	.075	.32	.45	.64	.90	1.3	1.4	2.0	2.5	3.2	55	65	71	74
	10	.079	.35	.50	.71	1.0	1.4	1.6	2.2	2.7	3.5	56	65	71	74
	11	.083	.39	.55	.78	1.1	1.6	1.7	2.5	3.0	3.9	56	65	71	74
12	.087	.42	.60	.85	1.2	1.7	1.9	2.7	3.3	4.2	56	65	71	74	
13	.090	.46	.65	.92	1.3	1.8	2.1	2.9	3.6	4.6	56	65	71	74	
14	.093	.49	.70	.99	1.4	2.0	2.2	3.1	3.8	4.9	56	65	71	74	
15	.097	.53	.75	1.1	1.5	2.1	2.4	3.4	4.1	5.3	56	65	70	73	
20	.112	.71	1.0	1.4	2.0	2.8	3.2	4.5	5.5	7.1	57	65	70	73	
30	.133	1.1	1.5	2.1	3.0	4.2	4.7	6.7	8.2	10.6	58	65	69	72	
40	.153	1.4	2.0	2.8	4.0	5.7	6.3	8.9	11.0	14.1	59	65	68	72	
50	.172	1.8	2.5	3.5	5.0	7.1	7.9	11.2	13.7	17.7	60	65	68	71	
60	.188	2.1	3.0	4.2	6.0	8.5	9.5	13.4	16.4	21	60	65	68	71	
70	.203	2.5	3.5	4.9	7.0	9.9	11.1	15.7	19.2	25	60	65	68	71	
50°	0017	.011	–	–	.012	.017	.024	.027	.038	.047	.06	27	50	65	74
	0025	.013	–	–	.018	.025	.035	.040	.06	.07	.09	29	50	64	71
	0033	.015	–	–	.023	.033	.047	.052	.07	.09	.12	30	50	62	68
	0050	.018	–	–	.035	.050	.07	.08	.11	.14	.18	32	50	60	66
	0067	.021	–	–	.05	.067	.09	.11	.15	.18	.24	35	50	60	66
	01	.026	–	.05	.07	.10	.14	.16	.22	.27	.35	37	50	59	65
	015	.032	–	.08	.11	.15	.21	.24	.34	.41	.53	38	50	58	64
	02	.035	–	.10	.14	.20	.28	.32	.45	.55	.71	39	50	57	63
	025	.039	.09	.13	.18	.25	.35	.40	.56	.68	.88	40	50	57	63
	03	.043	.11	.15	.21	.30	.42	.47	.67	.82	1.1	40	50	56	62
	035	.047	.12	.18	.25	.35	.49	.55	.78	.96	1.2	40	50	56	61

Other body types may be available. Contact your sales engineer for further information. **Highlighted column shows the rated pressure of the nozzles.**

\*PulsaJet® Series (except for 104210, 104214, 104215 and 0050)





PERFORMANCE DATA:  
UNIJET® TPU HYDRAULIC FLAT SPRAY TIPS

Spray Angle at 40 psi	Capacity Size	Equiv. Orifice Dia. (in.)	Flow Rate Capacity (gallons per minute)									Spray Angle (°)			
			5 psi	10 psi	20 psi	40 psi	80 psi	100 psi	200 psi	300 psi	500 psi	20 psi	40 psi	80 psi	200 psi
50°	04	.050	.14	.20	.28	.40	.57	.63	.89	1.1	1.4	42	50	56	61
	05	.056	.18	.25	.35	.50	.71	.79	1.1	1.4	1.8	44	50	56	61
	06	.061	.21	.30	.42	.60	.85	.95	1.3	1.6	2.1	45	50	56	60
	07	.066	.25	.35	.49	.70	.99	1.1	1.6	1.9	2.5	45	50	56	60
	075	.068	.27	.38	.53	.75	1.1	1.2	1.7	2.1	2.7	45	50	55	60
	08	.071	.28	.40	.57	.80	1.1	1.3	1.8	2.2	2.8	45	50	55	60
	09	.075	.32	.45	.64	.90	1.3	1.4	2.0	2.5	3.2	45	50	55	59
	10	.079	.35	.50	.71	1.0	1.4	1.6	2.2	2.7	3.5	45	50	55	59
	13	.090	.46	.65	.92	1.3	1.8	2.1	2.9	3.6	4.6	45	50	55	59
	15	.097	.53	.75	1.1	1.5	2.1	2.4	3.4	4.1	5.3	45	50	55	59
	20	.112	.71	1.0	1.4	2.0	2.8	3.2	4.5	5.5	7.1	45	50	55	59
	30	.133	1.1	1.5	2.1	3.0	4.2	4.7	6.7	8.2	10.6	45	50	55	59
	40	.153	1.4	2.0	2.8	4.0	5.7	6.3	8.9	11.0	14.1	46	50	54	59
	50	.172	1.8	2.5	3.5	5.0	7.1	7.9	11.2	13.7	17.7	46	50	54	59
	60	.188	2.1	3.0	4.2	6.0	8.5	9.5	13.4	16.4	21	46	50	54	59
70	.203	2.5	3.5	4.9	7.0	9.9	11.1	15.7	19.2	25	46	50	54	59	
40°	0017	.011	-	-	.012	.017	.024	.027	.038	.047	.06	21	40	54	61
	0025	.013	-	-	.018	.025	.035	.040	.06	.07	.09	22	40	53	60
	0033	.015	-	-	.023	.033	.047	.052	.07	.09	.12	22	40	53	60
	0050	.018	-	-	.035	.050	.07	.08	.11	.14	.18	22	40	53	60
	0067	.021	-	-	.05	.067	.09	.11	.15	.18	.24	24	40	53	60
	01	.026	-	-	.07	.10	.14	.16	.22	.27	.35	26	40	52	59
	015	.032	-	-	.11	.15	.21	.24	.34	.41	.53	27	40	52	59
	02	.035	-	.10	.14	.20	.28	.32	.45	.55	.71	29	40	51	58
	025	.039	-	.13	.18	.25	.35	.40	.56	.68	.88	29	40	51	58
	03	.043	-	.15	.21	.30	.42	.47	.67	.82	1.1	30	40	50	57
	04	.050	-	.20	.28	.40	.57	.63	.89	1.1	1.4	30	40	50	56
	05	.056	-	.25	.35	.50	.71	.79	1.1	1.4	1.8	31	40	49	55
	055	.059	-	.28	.39	.55	.78	.87	1.2	1.5	1.9	31	40	49	55
	06	.061	-	.30	.42	.60	.85	.95	1.3	1.6	2.1	31	40	49	55
	07	.066	.25	.35	.49	.70	.99	1.1	1.6	1.9	2.5	31	40	49	55
	08	.071	.28	.40	.57	.80	1.1	1.3	1.8	2.2	2.8	31	40	47	53
	09	.075	.32	.45	.64	.90	1.3	1.4	2.0	2.5	3.2	32	40	45	48
	10	.079	.35	.50	.71	1.0	1.4	1.6	2.2	2.7	3.5	32	40	45	48
	11	.083	.39	.55	.78	1.1	1.6	1.7	2.5	3.0	3.9	32	40	45	48
	12	.087	.42	.60	.85	1.2	1.7	1.9	2.7	3.3	4.2	32	40	45	48
13	.090	.46	.65	.92	1.3	1.8	2.1	2.9	3.6	4.6	32	40	45	48	
15	.097	.53	.75	1.1	1.5	2.1	2.4	3.4	4.1	5.3	32	40	45	48	
20	.112	.71	1.0	1.4	2.0	2.8	3.2	4.5	5.5	7.1	32	40	45	48	
25	.121	.88	1.3	1.8	2.5	3.5	4.0	5.6	6.8	8.8	32	40	45	48	
30	.133	1.1	1.5	2.1	3.0	4.2	4.7	6.7	8.2	10.6	33	40	45	48	

Other body types may be available. Contact your sales engineer for further information. **Highlighted column shows the rated pressure of the nozzles.**

\*PulsaJet® Series (except for 104210, 104214, 104215 and 0050)



**UNIJET® TPU HYDRAULIC FLAT SPRAY TIPS**

FOR PULSAJET® SERIES\*, JAUAH, JJAUH, AA22AUH, AA24AUA, AA26AUH, D55500-JAUH SERIES

**PERFORMANCE DATA:  
UNIJET® TPU HYDRAULIC FLAT SPRAY TIPS**

Spray Angle at 40 psi	Capacity Size	Equiv. Orifice Dia. (in.)	Flow Rate Capacity (gallons per minute)									Spray Angle (°)			
			5 psi	10 psi	20 psi	40 psi	80 psi	100 psi	200 psi	300 psi	500 psi	20 psi	40 psi	80 psi	200 psi
40°	40	.153	1.4	2.0	2.8	4.0	5.7	6.3	8.9	11.0	14.1	34	40	45	48
	50	.172	1.8	2.5	3.5	5.0	7.1	7.9	11.2	13.7	17.7	35	40	45	48
	60	.188	2.1	3.0	4.2	6.0	8.5	9.5	13.4	16.4	21	35	40	45	48
	70	.203	2.5	3.5	4.9	7.0	9.9	11.1	15.7	19.2	25	35	40	45	48
25°	0017	.011	-	-	-	.017	.024	.027	.038	.047	.06	-	25	35	47
	0025	.013	-	-	-	.025	.035	.040	.06	.07	.09	-	25	35	45
	0033	.015	-	-	-	.033	.047	.052	.07	.09	.12	-	25	34	44
	0050	.018	-	-	-	.050	.07	.08	.11	.14	.18	-	25	34	43
	0067	.021	-	-	-	.067	.09	.11	.15	.18	.24	-	25	34	42
	01	.026	-	-	.07	.10	.14	.16	.22	.27	.35	14	25	34	42
	015	.032	-	-	.11	.15	.21	.24	.34	.41	.53	15	25	34	41
	02	.035	-	-	.14	.20	.28	.32	.45	.55	.71	15	25	33	40
	03	.043	-	-	.21	.30	.42	.47	.67	.82	1.1	15	25	33	40
	04	.050	-	.20	.28	.40	.57	.63	.89	1.1	1.4	16	25	32	39
	05	.056	-	.25	.35	.50	.71	.79	1.1	1.4	1.8	16	25	32	39
	055	.059	-	.28	.39	.55	.78	.87	1.2	1.5	1.9	16	25	32	39
	06	.061	-	.30	.42	.60	.85	.95	1.3	1.6	2.1	17	25	31	38
	07	.066	-	.35	.49	.70	.99	1.1	1.6	1.9	2.5	17	25	31	38
	08	.071	-	.40	.57	.80	1.1	1.3	1.8	2.2	2.8	17	25	31	38
	09	.075	-	.45	.64	.90	1.3	1.4	2.0	2.5	3.2	17	25	31	38
	10	.079	-	.50	.71	1.0	1.4	1.6	2.2	2.7	3.5	18	25	31	37
	13	.090	-	.65	.92	1.3	1.8	2.1	2.9	3.6	4.6	18	25	31	37
	15	.097	-	.75	1.1	1.5	2.1	2.4	3.4	4.1	5.3	18	25	31	37
	20	.112	-	1.0	1.4	2.0	2.8	3.2	4.5	5.5	7.1	19	25	31	37
30	.133	1.1	1.5	2.1	3.0	4.2	4.7	6.7	8.2	10.6	20	25	30	36	
40	.153	1.4	2.0	2.8	4.0	5.7	6.3	8.9	11.0	14.1	21	25	29	35	
50	.172	1.8	2.5	3.5	5.0	7.1	7.9	11.2	13.7	17.7	21	25	29	35	
60	.188	2.1	3.0	4.2	6.0	8.5	9.5	13.4	16.4	21	22	25	29	35	
70	.203	2.5	3.5	4.9	7.0	9.9	11.1	15.7	19.2	25	22	25	29	35	
15°	0017	.011	-	-	-	.017	.024	.027	.038	.047	.06	-	15	30	37
	0025	.013	-	-	-	.025	.035	.040	.06	.07	.09	-	15	28	34
	0033	.015	-	-	-	.033	.047	.052	.07	.09	.12	-	15	27	32
	0050	.018	-	-	-	.050	.07	.08	.11	.14	.18	-	15	26	30
	0067	.021	-	-	-	.067	.09	.11	.15	.18	.24	-	15	25	29
	01	.026	-	-	-	.10	.14	.16	.22	.27	.35	-	15	24	28
	015	.032	-	-	-	.15	.21	.24	.34	.41	.53	-	15	23	27
	02	.035	-	-	.14	.20	.28	.32	.45	.55	.71	6	15	22	27
	03	.043	-	-	.21	.30	.42	.47	.67	.82	1.1	6	15	22	27
	04	.050	-	-	.28	.40	.57	.63	.89	1.1	1.4	7	15	21	26
	05	.056	-	-	.35	.50	.71	.79	1.1	1.4	1.8	7	15	21	26
	055	.059	-	-	.39	.55	.78	.87	1.2	1.5	1.9	7	15	21	26

Other body types may be available. Contact your sales engineer for further information. **Highlighted column shows the rated pressure of the nozzles.**

\*PulsaJet® Series (except for 104210, 104214, 104215 and 0050)



PERFORMANCE DATA:  
UNIJET® TPU HYDRAULIC FLAT SPRAY TIPS

Spray Angle at 40 psi	Capacity Size	Equiv. Orifice Dia. (in.)	Flow Rate Capacity (gallons per minute)									Spray Angle (°)				
			5 psi	10 psi	20 psi	40 psi	80 psi	100 psi	200 psi	300 psi	500 psi	20 psi	40 psi	80 psi	200 psi	
15°	06	.061	–	–	.42	.60	.85	.95	1.3	1.6	2.1	8	15	21	26	
	07	.066	–	–	.49	.70	.99	1.1	1.6	1.9	2.5	8	15	21	26	
	08	.071	–	–	.57	.80	1.1	1.3	1.8	2.2	2.8	9	15	20	25	
	09	.075	–	–	.64	.90	1.3	1.4	2.0	2.5	3.2	9	15	20	25	
	10	.079	–	–	.71	1.0	1.4	1.6	2.2	2.7	3.5	10	15	19	24	
	11	.083	–	.55	.78	1.1	1.6	1.7	2.5	3.0	3.9	10	15	19	24	
	12	.087	.42	.60	.85	1.2	1.7	1.9	2.7	3.3	4.2	10	15	19	24	
	15	.097	.53	.75	1.1	1.5	2.1	2.4	3.4	4.1	5.3	10	15	19	24	
	20	.112	.71	1.0	1.4	2.0	2.8	3.2	4.5	5.5	7.1	10	15	19	23	
	30	.133	1.1	1.5	2.1	3.0	4.2	4.7	6.7	8.2	10.6	10	15	19	21	
	40	.153	1.4	2.0	2.8	4.0	5.7	6.3	8.9	11.0	14.1	10	15	18	21	
	50	.172	1.8	2.5	3.5	5.0	7.1	7.9	11.2	13.7	17.7	11	15	18	21	
	60	.188	2.1	3.0	4.2	6.0	8.5	9.5	13.4	16.4	21	11	15	18	21	
70	.203	2.5	3.5	4.9	7.0	9.9	11.1	15.7	19.2	25	11	15	18	21		
0°	0009	.008	.003	.003	.005	.009	.013	.014	.020	.025	.032	0° Solid Stream				
	0012	.010	.004	.006	.008	.012	.017	.019	.027	.033	.042					
	0019	.012	.007	.009	.013	.019	.027	.030	.043	.052	.067					
	0021	.013	.007	.010	.011	.023	.033	.040	.047	.052	.074					
	0033	.016	.01	.02	.023	.033	.047	.052	.07	.09	.12					
	0050	.019	.018	.025	.035	.050	.07	.08	.11	.14	.18					
	0067	.023	.024	.033	.05	.067	.09	.11	.15	.18	.24					
	01	.028	.035	.05	.07	.10	.14	.16	.22	.27	.35					
	015	.034	.05	.08	.11	.15	.21	.24	.34	.41	.53					
	02	.039	.07	.10	.14	.20	.28	.32	.45	.55	.71					
	03	.041	.11	.15	.21	.30	.42	.47	.67	.82	1.1					
	04	.047	.14	.20	.28	.40	.57	.63	.89	1.1	1.4					
	045	.052	.16	.23	.32	.45	.64	.71	1.0	1.2	1.6					
	05	.053	.18	.25	.35	.50	.71	.79	1.1	1.4	1.8					
	055	.055	.19	.28	.39	.55	.78	.87	1.2	1.5	1.9					
	06	.058	.21	.30	.42	.60	.85	.95	1.3	1.6	2.1					
	065	.060	.23	.33	.46	.65	.92	1.0	1.5	1.8	2.3					
	07	.062	.25	.35	.49	.70	.99	1.1	1.6	1.9	2.5					
	08	.067	.28	.40	.57	.80	1.1	1.3	1.8	2.2	2.8					
	09	.071	.32	.45	.64	.90	1.3	1.4	2.0	2.5	3.2					
	10	.075	.35	.50	.71	1.0	1.4	1.6	2.2	2.7	3.5					
	11	.079	.39	.55	.78	1.1	1.6	1.7	2.5	3.0	3.9					
	12	.082	.42	.60	.85	1.2	1.7	1.9	2.7	3.3	4.2					
	15	.091	.53	.75	1.1	1.5	2.1	2.4	3.4	4.1	5.3					
20	.106	.71	1.0	1.4	2.0	2.8	3.2	4.5	5.5	7.1						
30	.129	1.1	1.5	2.1	3.0	4.2	4.7	6.7	8.2	10.6						
40	.149	1.4	2.0	2.8	4.0	5.7	6.3	8.9	11.0	14.1						

Other body types may be available. Contact your sales engineer for further information. **Highlighted column shows the rated pressure of the nozzles.**

\*PulsaJet® Series (except for 104210, 104214, 104215 and 0050)





**PERFORMANCE DATA:  
UNIJET PWMD PREMIUM HYDRAULIC FLAT SPRAY TIPS\***

Tip No. TPU PWMD	Equiv. Orifice Dia. (in.)	Marking	Flow Rate Capacity (gallons per minute)					Spray Angle (°)		
			20 psi	40 psi	60 psi	80 psi	100 psi	20 psi	40 psi	80 psi
1100033	.015	WH	.023	.033	.04	.047	.052	91	110	116
1100050	.018	WJ	.035	.050	.06	.07	.08	91	110	118
1100067	.021	WK	.05	.067	.08	.09	.11	92	110	118
11001	.026	WL	.07	.10	.12	.14	.16	94	110	121
110015	.031	WM	.11	.15	.18	.21	.24	97	110	121
11002	.035	WN	.14	.20	.24	.28	.32	98	110	120
11003	.043	WO	.21	.30	.37	.42	.47	99	110	120
950033	.015	9H	.023	.033	.04	.047	.052	81	95	105
950050	.018	9J	.035	.050	.06	.07	.08	81	95	105
950067	.021	9K	.05	.067	.08	.09	.11	81	95	105
9501	.026	9L	.07	.10	.12	.14	.16	81	95	105
95015	.031	9M	.11	.15	.18	.21	.24	81	95	105
9502	.035	9N	.14	.20	.24	.28	.32	82	95	105
9503	.043	9O	.21	.30	.37	.42	.47	83	95	104
800025	.013	8G	.018	.025	.031	.035	.040	61	80	95
800033	.015	8H	.020	.033	.040	.050	.052	61	80	95
800050	.018	8J	.035	.050	.06	.07	.08	61	80	95
800067	.021	8K	.05	.067	.08	.09	.11	67	80	94
8001	.026	8L	.07	.10	.12	.14	.16	68	80	89
80015	.031	8M	.11	.15	.18	.21	.24	68	80	89
8002	.035	8N	.14	.20	.24	.28	.32	69	80	88
8003	.043	8O	.21	.30	.37	.42	.47	70	80	87
650025	.013	6G	.018	.025	.031	.035	.040	45	65	77
650033	.015	6H	.023	.033	.040	.047	.052	47	65	76
650050	.018	6J	.035	.050	.06	.07	.08	48	65	75
650067	.021	6K	.018	.025	.031	.035	.040	50	65	75
6501	.026	6L	.07	.10	.12	.14	.16	51	65	74
65015	.031	6M	.11	.15	.18	.21	.24	51	65	74
6502	.035	6N	.14	.20	.24	.28	.32	52	65	73
6503	.043	6O	.21	.30	.37	.42	.47	53	65	72
500025	.013	5G	.018	.025	.031	.035	.040	29	50	64
500033	.015	5H	.023	.033	.040	.047	.052	30	50	62
500050	.018	5J	.035	.050	.061	.07	.08	32	50	60
500067	.021	5K	.05	.067	.08	.09	.11	35	50	60
5001	.026	5L	.07	.10	.12	.14	.16	37	50	59
50015	.031	5M	.11	.15	.18	.21	.24	38	50	58
5002	.035	5N	.14	.20	.24	.28	.32	39	50	57
5003	.043	5O	.21	.30	.37	.42	.47	40	50	56
400025	.013	4G	.018	.025	.031	.035	.040	40	50	56
400033	.015	4H	.023	.033	.040	.047	.052	22	40	53
400050	.018	4J	.035	.050	.061	.07	.08	22	40	53



PERFORMANCE DATA:  
UNIJET PWMD PREMIUM HYDRAULIC FLAT SPRAY TIPS\*

Tip No. TPU PWMD	Equiv. Orifice Dia. (in.)	Marking	Flow Rate Capacity (gallons per minute)					Spray Angle (°)		
			20 psi	40 psi	60 psi	80 psi	100 psi	20 psi	40 psi	80 psi
400067	.021	4K	.05	.067	.08	.09	.11	24	40	53
4001	.026	4L	.07	.10	.12	.14	.16	26	40	52
40015	.031	4M	.11	.15	.18	.21	.24	27	40	52
4002	.035	4N	.14	.20	.24	.28	.32	29	40	51
4003	.043	4O	.21	.30	.37	.42	.47	30	40	50
250025	.013	3G	.018	.025	.031	.035	.040	–	25	35
250033	.015	3H	.023	.033	.040	.047	.052	–	25	34
250050	.018	3J	.035	.050	.06	.07	.08	–	25	34
250067	.021	3K	.05	.067	.08	.09	.11	–	25	34
2501	.026	3L	.07	.10	.12	.14	.16	14	25	34
25015	.031	3M	.11	.15	.18	.21	.24	15	25	34
2502	.035	3N	.14	.20	.24	.28	.32	15	25	33
2503	.043	3O	.21	.30	.37	.42	.47	15	25	33
150025	.013	2G	.018	.025	.031	.035	.040	–	15	28
150033	.015	2H	.023	.033	.040	.047	.052	–	15	27
150050	.018	2J	.035	.050	.06	.07	.08	–	15	26
150067	.021	2K	.05	.067	.08	.09	.11	–	15	25
1501	.026	2L	.07	.10	.12	.14	.16	–	15	24
15015	.031	2M	.11	.15	.18	.21	.24	–	15	23
1502	.035	2N	.14	.20	.24	.28	.32	6	15	22
1503	.043	2O	.21	.30	.37	.42	.47	6	15	22

\*For PulsaJet 104210, 104214, 104215



PERFORMANCE DATA:  
UNIJET PWMM PREMIUM HYDRAULIC FLAT SPRAY TIPS\*

Tip No. TPU_PWMM-SS	Marking	Flow Rate Capacity (gallons per minute)	Spray Angle (°)
		40 psi	40 psi
1100033	WH	.033	110
1100050	WJ	.050	110
950025	9G	.025	95
950033	9H	.033	95
950050	9J	.050	95
800025	8G	.025	80
800033	8H	.033	80
800050	8J	.050	80
650025	6G	.025	65
650033	6H	.033	65
650050	6J	.050	65

\*For PulsaJet 0050 nozzles



**UNIJET® TP-TC HYDRAULIC FLAT SPRAY TIPS**

FOR JUAUH, JJAUH, AA22AUH, AA24AUA, AA26AUH, D55500-JAUH NOZZLES



**PERFORMANCE DATA:  
UNIJET TP-TC HYDRAULIC FLAT SPRAY TIPS**

Spray Angle at 40 psi	Spray Tip Number	Equiv. Orifice Dia.	Flow Rate Capacity (gallons per minute)					Approx.** Spray Pattern Width (in.) (at 1 foot distance)	
			500 psi	1000 psi	1500 psi	2000 psi	3000 psi		
110°	1100017-TC	.011"	.06	.09	.10	.12	.15	15-1/2	
	1100025-TC	.013"	.09	.12	.15	.18	.22	16-1/2	
	1100033-TC	.015"	.12	.16	.20	.23	.29	17	
	1100039-TC	.016"	.14	.20	.24	.28	.34	18	
	1100050-TC	.018"	.18	.25	.30	.36	.44	19	
	1100067-TC	.021"	.24	.33	.41	.47	.59	21	
	1100080-TC	.023"	.28	.40	.49	.57	.69	22	
	11001-TC	.026"	.35	.50	.61	.72	.86	23	
	110015-TC	.031"	.53	.75	.91	1.1	1.3	25	
	11002-TC	.036"	.71	1.0	1.2	1.4	1.7	26	
	11003-TC	.043"	1.1	1.5	1.8	2.1	2.7	27	
	11004-TC	.052"	1.4	2.0	2.5	2.8	3.4	28	
	11005-TC	.057"	1.8	2.5	3.1	3.5	4.4	28	
	110053-TC	.058"	1.9	2.7	3.2	3.7	4.7	28	
	11006-TC	.062"	2.1	3.0	3.7	4.2	5.1	28	
	11007-TC	.067"	2.5	3.5	4.3	5.0	6.1	28	
	11008-TC	.072"	2.8	4.0	4.9	5.7	6.9	28	
	11009-TC	.076"	3.2	4.5	5.5	6.4	7.8	28	
11010-TC	.078"	3.5	5.0	6.1	7.1	8.6	28		
11011-TC	.083"	3.9	5.5	6.7	7.8	9.6	28		
11012-TC	.089"	4.3	6.0	7.4	8.5	10.5	28		
95°	950017-TC	.011"	.06	.08	.10	.12	.15	13	
	950025-TC	.013"	.09	.12	.15	.18	.22	14	
	950033-TC	.015"	.12	.16	.20	.23	.29	15	
	950039-TC	.016"	.14	.20	.24	.28	.34	16	
	950044-TC	.017"	.16	.22	.27	.31	.39	16	
	950050-TC	.018"	.18	.25	.30	.36	.44	17	
	950067-TC	.021"	.24	.33	.41	.47	.59	19	
	950080-TC	.023"	.28	.40	.49	.57	.69	19	
	9501-TC	.026"	.35	.50	.61	.72	.86	21	
	95015-TC	.031"	.53	.75	.91	1.1	1.3	21	
	9502-TC	.036"	.71	1.0	1.2	1.4	1.7	22	
	9503-TC	.043"	1.1	1.5	1.8	2.1	2.7	22	
	9504-TC	.052"	1.4	2.0	2.5	2.8	3.4	23	
	9505-TC	.057"	1.8	2.5	3.1	3.5	4.4	23	
	9506-TC	.062"	2.1	3.0	3.7	4.2	5.1	23	
	90°	900011-TC	.009"	.04	.06	.07	.08	.10	10-1/2
		900017-TC	.011"	.06	.08	.10	.12	.15	11-1/2
		900025-TC	.013"	.09	.12	.15	.18	.22	12-1/2
900033-TC		.015"	.12	.16	.20	.23	.29	13	
900039-TC		.016"	.14	.20	.24	.28	.34	14	
900050-TC		.018"	.18	.25	.30	.36	.44	15	
900067-TC		.021"	.24	.33	.41	.47	.59	17	
900080-TC		.023"	.28	.40	.49	.57	.69	17	
9001-TC		.026"	.35	.50	.61	.72	.86	19	
90015-TC		.031"	.53	.75	.91	1.1	1.3	19	
9002-TC		.036"	.71	1.0	1.2	1.4	1.7	19	
9003-TC		.043"	1.1	1.5	1.8	2.1	2.7	19	
9004-TC		.052"	1.4	2.0	2.5	2.8	3.4	19	
9005-TC		.057"	1.8	2.5	3.1	3.5	4.4	19	
9006-TC		.062"	2.1	3.0	3.7	4.2	5.1	19	
9007-TC		.067"	2.5	3.5	4.3	5.0	6.1	19	
9008-TC		.072"	2.8	4.0	4.9	5.7	6.9	19	
9009-TC		.076"	3.2	4.5	5.5	6.4	7.8	19	
9010-TC	.078"	3.5	5.0	6.1	7.1	8.6	19		
9011-TC	.085"	3.9	5.5	6.7	7.8	9.6	19		
9012-TC	.089"	4.3	6.0	7.4	8.5	10.5	19		
9013-TC	.093"	4.6	6.5	8.0	9.2	11.3	19		
9014-TC	.096"	4.9	7.0	8.6	9.9	12.0	19		
9015-TC	.099"	5.3	7.5	9.2	10.6	13.0	19		

\* Tabulated capacities based on water.

\*\* Spray pattern width is based on liquid with viscosity of 20 seconds, #4 Zahn Cup spraying at 1600 psi (110 bar). Coverage will vary with viscosities and pressures.



**PERFORMANCE DATA:  
 UNIJET TP-TC HYDRAULIC FLAT SPRAY TIPS**

Spray Angle at 40 psi	Spray Tip Number	Equiv. Orifice Dia.	Flow Rate Capacity (gallons per minute)					Approx.** Spray Pattern Width (in.) (at 1 foot distance)
			500 psi	1000 psi	1500 psi	2000 psi	3000 psi	
73°	730023-TC	.012"	.08	.11	.14	.16	.20	11-1/2
	730039-TC	.016"	.14	.20	.24	.28	.34	13
	730044-TC	.017"	.17	.22	.27	.31	.42	13
	730050-TC	.018"	.18	.25	.31	.35	.44	13
	730154-TC	.031"	.54	.77	.94	1.1	1.3	13
65°	650008-TC	.007"	.03	.04	.05	.06	.07	8-1/2
	650011-TC	.009"	.04	.06	.07	.08	.10	9-1/4
	650017-TC	.011"	.06	.08	.10	.12	.15	10
	650025-TC	.013"	.09	.12	.15	.18	.22	10-1/2
	650033-TC	.015"	.12	.16	.20	.23	.29	11
	650039-TC	.016"	.14	.20	.24	.28	.34	12
	650044-TC	.017"	.16	.22	.27	.31	.39	12-1/2
	650050-TC	.018"	.18	.25	.30	.36	.44	13
	650055-TC	.019"	.19	.28	.34	.39	.47	13
	650067-TC	.021"	.24	.33	.41	.47	.59	15
	650080-TC	.023"	.28	.40	.49	.57	.69	15
	6501-TC	.026"	.35	.50	.61	.72	.86	16
	65015-TC	.031"	.53	.75	.91	1.1	1.3	16
	6502-TC	.036"	.71	1.0	1.2	1.4	1.7	16
	6503-TC	.043"	1.1	1.5	1.8	2.1	2.7	16
	6504-TC	.052"	1.4	2.0	2.5	2.8	3.4	16
	6505-TC	.057"	1.8	2.5	3.1	3.5	4.4	16
	6506-TC	.062"	2.1	3.0	3.7	4.2	5.1	16
	6507-TC	.067"	2.5	3.5	4.3	5.0	6.1	16
	6508-TC	.072"	2.8	4.0	4.9	5.7	6.9	16
	6509-TC	.076"	3.2	4.5	5.5	6.4	7.8	16
	6510-TC	.078"	3.5	5.0	6.1	7.1	8.6	16
	6511-TC	.085"	3.9	5.5	6.7	7.8	9.6	16
6512-TC	.089"	4.3	6.0	7.4	8.5	10.5	16	
6513-TC	.093"	4.6	6.5	8.0	9.2	11.3	16	
6514-TC	.096"	4.9	7.0	8.6	9.9	12.0	16	
6515-TC	.099"	5.3	7.5	9.2	10.6	13.0	16	
6517-TC	.102"	6.0	8.5	10.4	12.0	14.7	16	
6520-TC	.109"	7.1	10.0	12.2	14.1	17.4	16	
50°	500004-TC	.005"	.01	.02	.02	.03	.03	6-1/2
	500006-TC	.006"	.02	.03	.04	.04	.05	7
	500008-TC	.007"	.03	.04	.05	.06	.07	7-3/4
	500011-TC	.009"	.04	.06	.07	.08	.10	8
	500017-TC	.011"	.06	.08	.10	.12	.15	8-1/2
	500025-TC	.013"	.09	.12	.15	.18	.22	9
	500033-TC	.015"	.12	.16	.20	.23	.29	10
	500039-TC	.016"	.14	.20	.24	.28	.34	10-1/2
	500044-TC	.017"	.16	.22	.27	.31	.39	10-1/2
	500050-TC	.018"	.18	.25	.30	.36	.44	11
	500055-TC	.019"	.19	.28	.34	.39	.47	11
	500067-TC	.021"	.24	.33	.41	.47	.59	12
	500080-TC	.023"	.28	.40	.49	.57	.69	13
	5001-TC	.026"	.35	.50	.61	.72	.86	14
	50015-TC	.031"	.53	.75	.91	1.1	1.3	14
	5002-TC	.036"	.71	1.0	1.2	1.4	1.7	14
	5003-TC	.043"	1.1	1.5	1.8	2.1	2.7	14
	5004-TC	.052"	1.4	2.0	2.5	2.8	3.4	14
	5005-TC	.057"	1.8	2.5	3.1	3.5	4.4	14
	5006-TC	.062"	2.1	3.0	3.7	4.2	5.1	14
	5007-TC	.067"	2.5	3.5	4.3	5.0	6.1	14
	5008-TC	.072"	2.8	4.0	4.9	5.7	6.9	14
	5010-TC	.078"	3.5	5.0	6.1	7.1	8.6	14
5015-TC	.099"	5.3	7.5	9.2	10.6	13.0	14	
40°	400004-TC	.005"	.01	.02	.03	.03	.03	6-1/2
	400006-TC	.006"	.02	.03	.04	.04	.05	6-1/2
	400008-TC	.007"	.03	.04	.05	.06	.07	6-1/2
	400011-TC	.009"	.04	.06	.07	.08	.10	7
	400017-TC	.011"	.06	.08	.10	.12	.15	7-1/2
	400025-TC	.013"	.09	.12	.15	.18	.22	8
	400033-TC	.015"	.12	.16	.20	.23	.29	8-1/2
	400039-TC	.016"	.14	.20	.24	.28	.34	9
	400044-TC	.017"	.16	.22	.27	.31	.39	9-1/2
	400050-TC	.018"	.18	.25	.30	.36	.44	10

\* Tabulated capacities based on water.

\*\* Spray pattern width is based on liquid with viscosity of 20 seconds, #4 Zahn Cup spraying at 1600 psi (110 bar). Coverage will vary with viscosities and pressures.







**PERFORMANCE DATA:  
 UNIJET TP-TC HYDRAULIC FLAT SPRAY TIPS**

Spray Angle at 40 psi	Spray Tip Number	Equiv. Orifice Dia.	Flow Rate Capacity (gallons per minute)					Approx.** Spray Pattern Width (in.) (at 1 foot distance)
			500 psi	1000 psi	1500 psi	2000 psi	3000 psi	
10°	100039-TC	.016"	.14	.20	.24	.28	.34	5
	100050-TC	.018"	.18	.25	.30	.36	.44	5
	100067-TC	.021"	.24	.33	.41	.47	.59	5-1/2
	100080-TC	.023"	.28	.40	.49	.57	.69	5-1/2
	1001-TC	.026"	.35	.50	.61	.72	.86	6
	10015-TC	.031"	.53	.75	.91	1.1	1.3	6
	1002-TC	.036"	.71	1.0	1.2	1.4	1.7	6
5°	050004-TC	.005"	.01	.02	.03	.03	.03	2-1/2
	050008-TC	.007"	.03	.04	.05	.06	.07	2-1/2
	050011-TC	.009"	.04	.06	.07	.08	.10	2-1/2

Spray Angle at 40 psi	Spray Tip Number	Equiv. Orifice Dia.	Flow Rate Capacity (gallons per minute)					Approx.** Spray Pattern Width (in.) (at 1 foot distance)
			500 psi	1000 psi	1500 psi	2000 psi	3000 psi	
5°	050017-TC	.011"	.06	.08	.10	.12	.15	3
	050025-TC	.013"	.09	.12	.15	.18	.22	3
	050033-TC	.015"	.12	.16	.20	.23	.29	3-1/2
	050039-TC	.016"	.14	.20	.24	.28	.34	4
	050050-TC	.018"	.18	.25	.30	.36	.44	4
	050067-TC	.021"	.24	.33	.41	.47	.59	4
	0501-TC	.026"	.35	.50	.61	.72	.86	4
	05015-TC	.031"	.53	.75	.91	1.1	1.3	4
	0502-TC	.036"	.71	1.0	1.2	1.4	1.7	4
	0503-TC	.043"	1.1	1.5	1.8	2.1	2.7	4

\*Tabulated capacities based on water.

\*\* Spray pattern width is based on liquid with viscosity of 20 seconds, #4 Zahn Cup spraying at 1600 psi (110 bar). Coverage will vary with viscosities and pressures.

**PLACING YOUR ORDER**

**Call 1.800.95.SPRAY for application assistance  
 or to place an order.**





**PERFORMANCE DATA:  
UNIJET TG HYDRAULIC FULL CONE SPRAY TIPS**

Body Inlet Conn. (in.)	Capacity Size	Orifice Dia. Nom. (in.)	Max. Free Passage Dia. (in.)	Flow Rate Capacity (gallons per minute)								Spray Angle (°)		
				5 psi	7 psi	10 psi	20 psi	40 psi	80 psi	100 psi	150 psi	7 psi	20 psi	80 psi
1/4	.3	.020	.016	–	–	–	.041	.057	.078	.087	.10	–	50	61
	.4	.022	.018	–	–	–	.055	.076	.10	.12	.14	–	56	63
	.5	.024	.020	–	–	–	.069	.095	.13	.14	.17	–	56	63
	.6	.027	.020	–	–	–	.083	.11	.16	.17	.21	–	54	62
	.7	.030	.020	–	–	–	.096	.13	.18	.20	.24	–	54	63
	1	.036	.025	–	–	.10	.14	.19	.26	.29	.35	–	58	53
	2	.047	.040	.15	.17	.20	.28	.38	.52	.58	.70	43	50	46
	3	.062	.040	.22	.25	.30	.41	.57	.78	.87	1.0	52	65	59
	3.5	.067	.050	.25	.30	.35	.48	.66	.91	1.0	1.2	43	50	46
	5	.082	.050	.36	.42	.50	.69	.95	1.3	1.4	1.7	52	65	59
	6.5	.094	.063	.47	.55	.65	.89	1.2	1.7	1.9	2.3	45	50	46
10	.109	.063	.73	.85	1.0	1.4	1.9	2.6	2.9	3.5	58	67	61	

Maximum Free Passage Diameter is the maximum diameter as listed of foreign matter that can pass through the nozzle without clogging. Other body sizes may be available. Contact your sales engineer for further information.

**Highlighted column shows the rated pressure of the nozzles.**



**PERFORMANCE DATA:  
UNIJET TG-W HYDRAULIC FULL CONE SPRAY TIPS**

Body Inlet Conn. (in.)	Capacity Size	Orifice Dia. Nom. (in.)	Max. Free Passage Dia. (in.)	Flow Rate Capacity (gallons per minute)							Spray Angle (°)		
				5 psi	7 psi	10 psi	15 psi	20 psi	40 psi	80 psi	5 psi	10 psi	80 psi
1/8, 1/4	2.8W	.063	.040	–	–	.28	.34	.39	.53	.73	–	120	102
	4.3W	.078	.040	–	–	.43	.52	.59	.81	1.1	–	120	102
	5.6W	.094	.040	–	.48	.56	.67	.77	1.1	1.5	–	120	102
	8W	.094	.050	–	.68	.80	.96	1.1	1.5	2.1	–	120	103
1/4	10W	.109	.050	.73	.85	1.0	1.2	1.4	1.9	2.6	112	120	103
	12W	.125	.050	.87	1.0	1.2	1.4	1.7	2.3	3.1	114	120	103
	14W	.141	.063	1.0	1.2	1.4	1.7	1.9	2.6	3.6	114	120	103

Maximum Free Passage Diameter is the maximum diameter as listed of foreign matter that can pass through the nozzle without clogging. Other body sizes may be available. Contact your sales engineer for further information.

**Highlighted column shows the rated pressure of the nozzles.**





PERFORMANCE DATA:  
 UNIJET® TX HYDRAULIC HOLLOW CONE SPRAY TIPS

Body Inlet Conn. (in.)	Capacity Size	Inlet Openings (in.)	Orifice Dia. Nom. (in.)	Flow Rate Capacity (gallons per hour)									Spray Angle (°)	
				20 psi	30 psi	40 psi	60 psi	80 psi	100 psi	150 psi	200 psi	400 psi	20 psi	40 psi
1/4	.60	One .012 x .010	.014	–	–	–	.73	.85	.95	1.2	1.3	1.9	–	–
	1	One .016 x .015	.020	–	.87	1.0	1.2	1.4	1.6	1.9	2.2	3.2	–	54
	1.25	One .020 x .020	.022	–	1.1	1.3	1.5	1.8	2.0	2.4	2.8	4.0	–	59
	1.5	One .024 x .020	.024	–	1.3	1.5	1.8	2.1	2.4	2.9	3.4	4.7	–	63
	2	One .028 x .024	.028	1.4	1.7	2.0	2.4	2.8	3.2	3.9	4.5	6.3	40	68
	2.5	One .030 x .029	.031	1.8	2.2	2.5	3.1	3.5	4.0	4.8	5.6	7.9	48	70
	3	One .036 x .034	.034	2.1	2.6	3.0	3.7	4.2	4.7	5.8	6.7	9.5	57	72
	4	One .040 x .034	.041	2.8	3.5	4.0	4.9	5.7	6.3	7.7	8.9	12.6	61	73
	5	Two .032 x .032	.044	3.5	4.3	5.0	6.1	7.1	7.9	9.7	11.2	15.8	63	73
	6	Two .040 x .032	.047	4.2	5.2	6.0	7.3	8.5	9.5	11.6	13.4	19.0	65	74
	8	Two .040 x .036	.055	5.7	6.9	8.0	9.8	11.3	12.6	15.5	17.9	25	66	74
	10	Two .050 x .030	.060	7.1	8.7	10.0	12.2	14.1	15.8	19.4	22	32	68	75
	12	Two .050 x .034	.067	8.5	10.4	12.0	14.7	17.0	19.0	23	27	38	69	76
	14	Two .055 x .034	.070	9.9	12.1	14.0	17.1	19.8	22	27	31	44	70	76
	18	Two .060 x .031	.079	12.7	15.6	18.0	22	25	28	35	40	57	71	77
22	Two .065 x .030	.086	15.6	19.1	22	27	31	35	43	49	70	71	78	
26	Two .065 x .030	.094	18.4	23	26	32	37	41	50	58	82	72	78	

Spray angle of all above tips is 80° at 100 psi (7 bar). Other body types may be available. Contact your sales engineer for more information.

Highlighted column shows the rated pressure of the nozzles.





**PERFORMANCE DATA:  
UNIJET® TN HYDRAULIC HOLLOW CONE SPRAY TIPS**

Body Inlet Conn. (in.)	Capacity Size	Orifice Dia. Nom. (in.)	Core No.	Flow Rate Capacity (gallons per hour)									Spray Angle (°)		
				30 psi	40 psi	60 psi	100 psi	200 psi	300 psi	500 psi	700 psi	1000 psi	40 psi	80 psi	300 psi
1/4	.30	.016	106	–	–	–	–	–	.82	1.1	1.3	1.5	–	–	51
	.40	.016	108	–	–	–	–	–	1.1	1.4	1.7	2.0	–	–	58
	.60	.016	206	–	–	–	.95	1.3	1.6	2.1	2.5	3.0	–	35	65
	1	.020	210	–	1.0	1.2	1.6	2.2	2.7	3.5	4.2	5.0	45	62	72
	1.5	.020	216	1.3	1.5	1.8	2.4	3.4	4.1	5.3	6.3	7.5	65	70	72
	2	.028	216	1.7	2.0	2.4	3.2	4.5	5.5	7.1	8.4	10.0	70	75	77
	3	.028	220	2.6	3.0	3.7	4.7	6.7	8.2	10.6	12.5	15.0	65	70	73
	4	.042	220	3.5	4.0	4.9	6.3	8.9	11.0	14.1	16.7	20	72	81	84
	6	.042	225	5.2	6.0	7.3	9.5	13.4	16.4	21	25	30	73	79	81
	8	.060	225	6.9	8.0	9.8	12.6	17.9	22	28	33	40	85	89	91
	10	.064	420	8.7	10.0	12.2	15.8	22	27	35	42	50	82	84	86
	12	.076	420	10.4	12.0	14.7	19.0	27	33	42	50	60	78	82	85
	14	.076	421	12.1	14.0	17.1	22	31	38	49	59	70	85	88	90
	18	.076	422	15.6	18.0	22	28	40	49	64	75	90	81	84	86
	22	.076	625	19.1	22	27	35	49	60	78	92	110	70	72	75
26	.086	625	23	26	32	41	58	71	92	109	130	73	74	77	

Other body types may be available. Contact your sales engineer for more information. **Highlighted column shows the rated pressure of the nozzles.**





**PERFORMANCE DATA:  
UNIJET® TN-SSTC HYDRAULIC HOLLOW CONE SPRAY TIPS**

Body Inlet Conn. (in.)	Capacity Size	Orifice Dia. Nom. (in.)	Flow Rate Capacity (gallons per hour)					Approximate Spray Pattern Dia. (at 1 foot distance) (in.)
			400 psi	750 psi	1000 psi	1500 psi	2000 psi	
1/4	.60	.016	1.9	2.6	3.0	3.7	4.2	3
	.80	.014	2.5	3.5	4.0	4.9	5.7	3
	.90	.016	2.8	3.9	4.5	5.5	6.4	3
	1	.020	3.2	4.3	5.0	6.1	7.1	3-1/2
	1.5	.020	4.7	6.5	7.5	9.2	10.6	3-1/2
	1.8	.025	5.7	7.8	9.0	11.0	12.7	4-1/2
	2	.028	6.3	8.7	10.0	12.2	14.1	4-1/2
	3	.028	9.5	13.0	15.0	18.4	21	6
	4	.042	12.6	17.3	20	24	28	8
	6	.042	19.0	26	30	37	42	10
	8	.060	25	35	40	49	57	12
	9	.060	28	39	45	55	64	14
	10	.064	32	43	50	61	71	16
	12	.076	38	52	60	73	85	18
	14	.076	44	61	70	86	99	14
	15	.081	47	65	75	92	106	16
	16	.086	51	69	80	98	113	18
	18	.076	57	78	90	110	127	16
20	.081	63	87	100	122	141	18	
22	.076	70	95	110	135	156	12	
24	.081	76	104	120	147	170	13	
26	.086	82	113	130	159	184	14	

Spray pattern diameter is based on liquid with viscosity of 20 seconds #3 Zahn Cup spraying at 1600 psi (110 bar).

Coverage will vary with viscosities and pressures. Tabulated capacities are based on water.

Other body types may be available. Contact your sales engineer for more information.

Calibration pressure = 40 psi (3 bar).

**PLACING YOUR ORDER**

**Call 1.800.95.SPRAY for application assistance  
or to place an order.**



**OVERVIEW: AIR ATOMIZING SPRAY NOZZLE SET-UPS**

- Each spray set-up – consisting of an air cap and a fluid cap – provides a specific spray pattern, flow rate and spray coverage
- Within each nozzle series, spray set-ups are interchangeable, for versatile performance
- Air and liquid can be externally or internally mixed to produce a completely atomized spray
- Drip Free™ spray set-ups are used for all nozzle assemblies containing shut-off or clean-out needles to ensure positive liquid shut-off

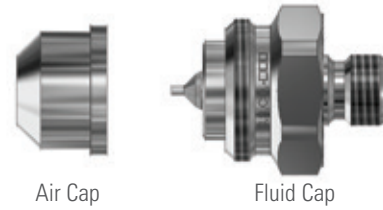

Air Cap

Fluid Cap

**Spray Set-Ups**

Each spray set-up consists of an air cap and a fluid cap.

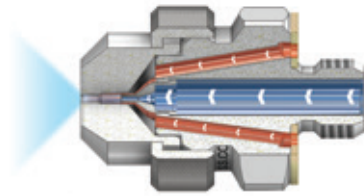

**Internal Mix Set-Ups**

Liquid and air are mixed internally to produce an atomized spray. Liquid and gas streams are not independent – a change in air flow will affect the liquid flow.

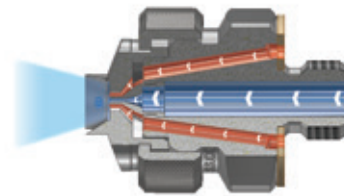

**External Mix Set-Ups**

Liquid and air streams are mixed outside of the nozzle. Air and liquid flow can be controlled independently. Effective for higher viscosity liquids and abrasive suspensions.

**QUICK REFERENCE GUIDE**

Spray Set-Up	Liquid Supply	Internal / External Mix	Spray Patterns	Max Flow	Page Number
<b>1/4J Series</b>	Pressure Feed Siphon/Gravity Feed	Both	<ul style="list-style-type: none"> <li>• Flat Spray</li> <li>• Deflected Flat Spray</li> <li>• Round Spray</li> <li>• Wide Angle Round Spray</li> <li>• 360° Circular Spray</li> </ul>	72 gph (272.5 lph)	D24
<b>1/8JJ Series</b>	Pressure Feed Siphon/Gravity Feed	Both	<ul style="list-style-type: none"> <li>• Flat Spray</li> <li>• Round Spray</li> <li>• Wide Angle Round Spray</li> <li>• 360° Circular Spray</li> </ul>	33.2 gph (126 lph)	D35
<b>1/2J Series</b>	Pressure Feed Siphon/Gravity Feed	Both	<ul style="list-style-type: none"> <li>• Flat Spray</li> <li>• Round Spray</li> <li>• Wide Angle Round Spray</li> </ul>	306 gph (1158 lph)	D43
<b>1J Series</b>	Pressure Feed Siphon/Gravity Feed	Both	<ul style="list-style-type: none"> <li>• Flat Spray</li> <li>• Round Spray</li> <li>• Wide Angle Round Spray</li> </ul>	29 gpm (110 lpm)	D49
<b>QuickMist® Series</b>	Pressure Feed Siphon/Gravity Feed	Internal Mix Only	<ul style="list-style-type: none"> <li>• Flat Spray</li> <li>• Round Spray</li> <li>• Wide Angle Round Spray</li> </ul>	26 gpm (98 lpm)	D54
<b>SUV and SUVM Series</b>	Pressure Feed Only	External Mix Only	<ul style="list-style-type: none"> <li>• Variable</li> </ul>	49.8 gph (188.5 lph)	D59 & D62



**OVERVIEW: AIR ATOMIZING SPRAY FEED SET-UPS**

- Liquid can be supplied to the nozzle under pressure or it can be supplied through a liquid siphon or gravity feed
- Filtration and pressure regulation are recommended on both the liquid and air line

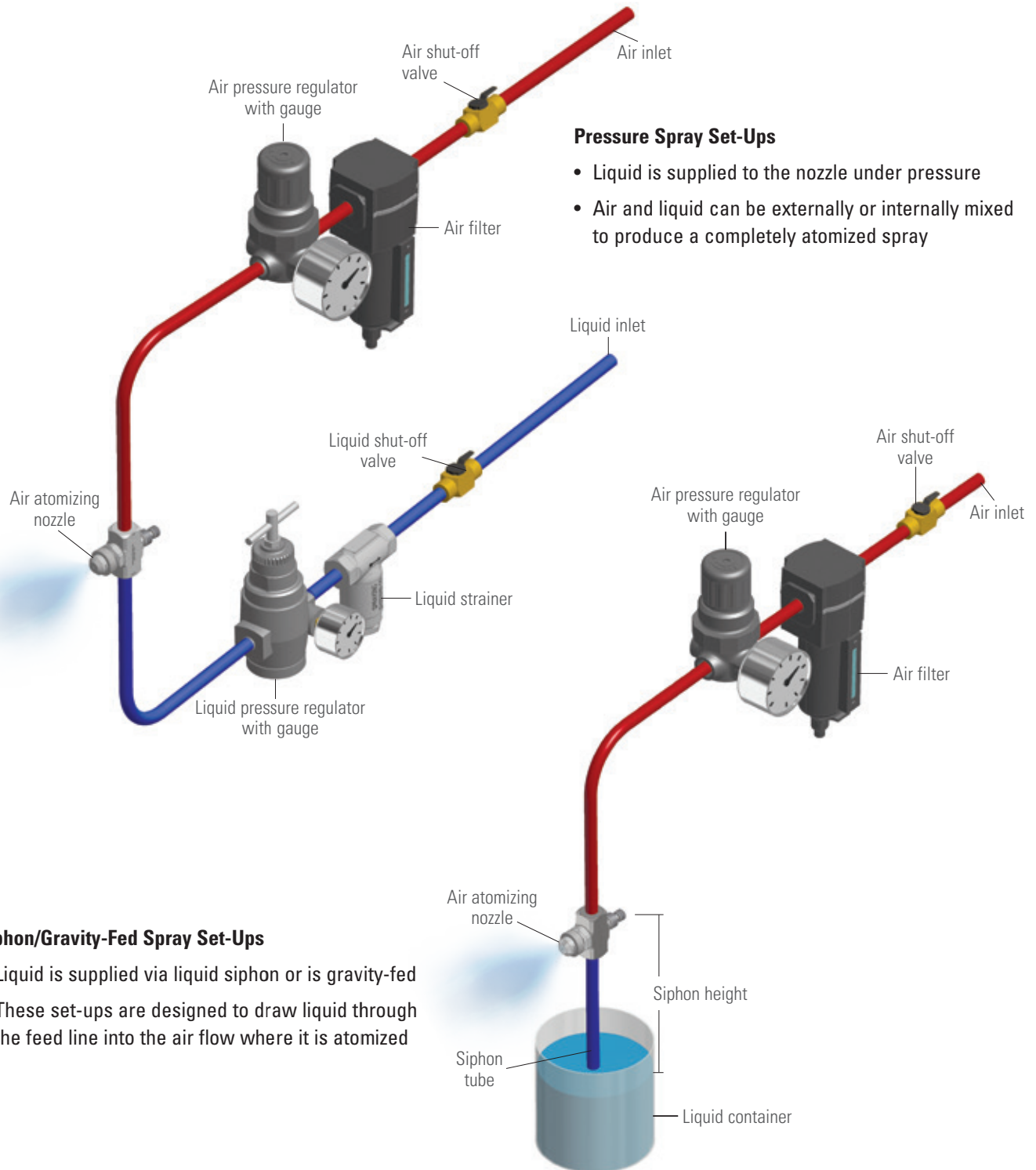

**Pressure Spray Set-Ups**

- Liquid is supplied to the nozzle under pressure
- Air and liquid can be externally or internally mixed to produce a completely atomized spray

**Siphon/Gravity-Fed Spray Set-Ups**

- Liquid is supplied via liquid siphon or is gravity-fed
- These set-ups are designed to draw liquid through the feed line into the air flow where it is atomized



**PERFORMANCE DATA:  
PRESSURE SPRAY SET-UPS | INTERNAL MIX | ROUND SPRAY**

For a round spray pattern, angle "A" is maintained throughout distance "B". Beyond "B", the spray becomes turbulent and projects out to distance "C".

Liquid is supplied to this spray set-up under pressure.

Liquid and compressed air or gas are mixed internally to produce a completely atomized spray.

When ordering only a spray set-up, 3199 retainer ring and 3612 gasket must be ordered separately. These components are included in a complete air atomizing nozzle assembly.

**Please contact your sales engineer for more information.**

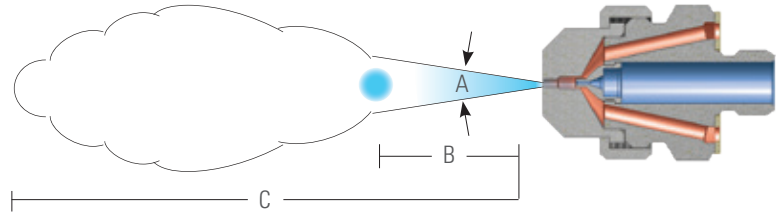

Spray Set-up No.	Spray Set-up Consists of Fluid and Air Cap Combination	Liquid Capacity (gallons per hour)* and Air Capacity (standard cubic feet per minute)*															Spray Dimensions		
		Liquid Pressure																	
		10 psi			20 psi			30 psi			40 psi			60 psi			Spray Angle A (°)	B (in.)	C (ft.)
		Air Press.	gph	scfm	Air Press.	gph	scfm	Air Press.	gph	scfm	Air Press.	gph	scfm	Air Press.	gph	scfm			
SU11	Fluid Cap 2050 + Air Cap 67147	10.0	.66	.55	14	1.50	.40	24	1.68	.56	32	1.86	.68	50	2.28	.98	13 - 15	12 - 17-1/2	9 - 14-1/2
		12.0	.48	.67	18	1.23	.50	28	1.44	.63	36	1.62	.80	54	2.05	1.07			
		14.0	.36	.78	22	.99	.63	32	1.08	.82	40	1.32	.93	58	1.80	1.19			
		-	-	-	24	.86	.70	36	.84	.96	44	1.08	1.07	62	1.56	1.36			
		-	-	-	26	.72	.76	38	.72	1.03	48	.85	1.23	66	1.32	1.52			
		-	-	-	28	.60	.82	40	.66	1.11	50	.72	1.33	68	1.23	1.58			
		-	-	-	30	.45	.93	42	.54	1.19	52	.66	1.38	70	1.11	1.66			
SU12A	Fluid Cap 2050 + Air Cap 73160	10.0	.66	.66	18	1.44	.87	24	1.98	1.00	30	2.40	1.14	40	3.30	1.36	12 - 15	17 - 22	12 - 17
		12.0	.54	.77	20	1.32	.98	28	1.68	1.17	34	2.16	1.29	46	2.94	1.54			
		14.0	.42	.90	22	1.20	1.06	32	1.44	1.35	38	1.92	1.47	52	2.58	1.83			
		-	-	-	24	1.08	1.16	34	1.32	1.46	42	1.62	1.68	58	2.28	2.09			
		-	-	-	26	.90	1.26	36	1.20	1.57	44	1.50	1.78	62	2.10	2.26			
		-	-	-	-	-	-	38	1.11	1.66	46	1.38	1.88	66	1.86	2.46			
		-	-	-	-	-	-	40	1.02	1.76	48	1.32	1.98	70	1.68	2.67			
SU12	Fluid Cap 2850 + Air Cap 73160	12.0	1.26	.73	22	2.16	1.05	30	2.90	1.24	36	4.32	1.26	48	5.82	1.50	12 - 15	19 - 23-1/2	13 - 17-1/2
		16.0	1.08	.94	26	1.74	1.26	34	2.46	1.42	40	3.85	1.36	52	5.28	1.65			
		20	.90	1.15	30	1.44	1.47	38	2.10	1.65	44	3.55	1.56	56	4.92	1.73			
		24	.78	1.36	38	1.08	1.87	46	1.50	2.03	52	2.46	2.01	64	4.08	2.08			
		28	.76	1.56	42	.94	2.04	52	1.20	2.36	60	1.86	2.36	70	3.60	2.34			

\*At the stated pressure in psi.

Drip Free™ spray set-ups ensure positive shut-off and are provided for air atomizing assemblies containing a shut-off needle. For more information, call 1.800.95.SPRAY.





**PERFORMANCE DATA:  
 PRESSURE SPRAY SET-UPS | INTERNAL MIX | ROUND SPRAY**

Spray Set-up No.	Spray Set-up Consists of Fluid and Air Cap Combination	Liquid Capacity (gallons per hour)* and Air Capacity (standard cubic feet per minute)*														Spray Dimensions			
		Liquid Pressure																	
		10 psi			20 psi			30 psi			40 psi			60 psi			Spray Angle A (°)	B (in.)	C (ft.)
		Air Press.	gph	scfm	Air Press.	gph	scfm	Air Press.	gph	scfm	Air Press.	gph	scfm	Air Press.	gph	scfm			
SU22B	Fluid Cap 40100 + Air Cap 1401110	16.0	3.44	2.68	28	5.03	3.71	40	6.10	4.72	48	7.75	5.30	65	10.7	6.74	18 - 21	26 - 38	16 - 30
		20	2.35	3.20	32	3.70	4.17	44	5.03	5.17	55	5.95	6.07	75	8.67	7.73			
		24	1.54	3.70	40	1.85	5.13	55	2.30	6.50	75	1.95	8.50	85	6.65	8.80			
		28	.96	4.22	48	.90	6.10	65	1.08	7.75	85	1.00	9.70	95	4.63	10.0			
SU22	Fluid Cap 60100 + Air Cap 1401110	12.0	8.1	2.00	20	13.6	2.55	30	16.3	3.25	38	19.5	3.74	54	25.7	4.66	17 - 21	24 - 36	16 - 28
		16.0	4.9	2.66	24	10.2	3.15	38	9.9	4.32	46	13.6	4.71	65	18.5	5.98			
		18.0	3.4	3.00	26	8.6	3.45	40	8.7	4.61	50	10.8	5.30	70	15.2	6.68			
		-	-	-	28	7.2	3.75	42	7.6	4.90	52	9.6	5.58	75	12.2	7.80			
		-	-	-	30	5.9	4.05	44	6.6	5.20	54	8.6	5.85	80	10.0	8.14			
		-	-	-	32	4.6	4.35	46	5.6	5.50	56	7.6	6.14	85	8.0	8.90			
SU42	Fluid Cap 100150 + Air Cap 1891125	14.0	11.7	3.05	20	27.5	3.04	28	36.6	3.55	32	49.4	3.31	42	70.6	3.17	19 - 22	35 - 46	20 - 30
		16.0	8.5	3.60	22	23.0	3.49	30	32.6	3.96	36	42.2	4.10	46	65.0	3.85			
		-	-	-	24	18.0	3.95	32	28.7	4.36	40	35.1	4.90	50	59.0	4.63			
		-	-	-	26	14.4	4.40	34	24.8	4.78	44	28.0	5.66	54	53.2	5.40			
		-	-	-	28	11.3	4.85	36	20.9	5.20	46	24.5	6.05	58	47.4	6.16			
		-	-	-	-	-	-	38	17.5	5.60	48	21.3	6.45	65	37.8	7.54			
		-	-	-	-	-	-	40	14.6	6.03	50	18.4	6.86	70	30.0	8.55			

\*At the stated pressure in psi.

Drip Free™ spray set-ups ensure positive shut-off and are provided for air atomizing assemblies containing a shut-off needle. For more information, call 1.800.95.SPRAY.

**PLACING YOUR ORDER**

**Call 1.800.95.SPRAY for application assistance  
 or to place an order.**





**PERFORMANCE DATA:  
PRESSURE SPRAY SET-UPS | INTERNAL MIX | WIDE ANGLE ROUND SPRAY**

For a wide angle round spray, dimensions "A" and "B" are the pattern widths at distances from the nozzle.

The total distance of spray projection from the nozzle to the maximum dispersal point is represented by "C".

Liquid is supplied to this spray set-up under pressure.

Liquid and compressed air or gas are mixed internally to produce a completely atomized spray.

When ordering only a spray set-up, 3199 retainer ring and 3612 gasket must be ordered separately. These components are included in a complete air atomizing nozzle assembly.

**Please contact your sales engineer for more information.**

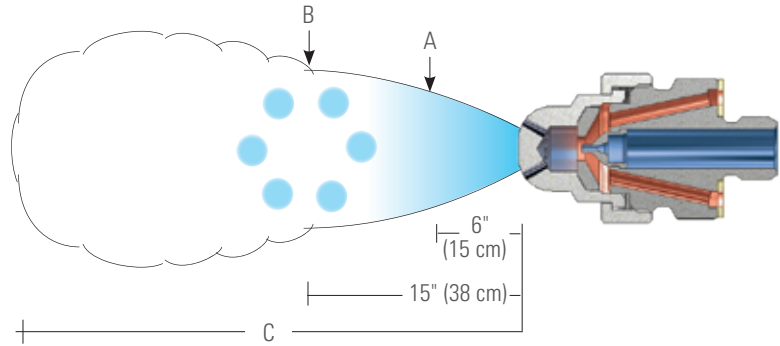

Spray Set-up No.	Spray Set-up Consists of Fluid and Air Cap Combination	Liquid Capacity (gallons per hour)* and Air Capacity (standard cubic feet per minute)*															Spray Dimensions		
		Liquid Pressure															A (in.)	B (in.)	C (ft.)
		10 psi			20 psi			30 psi			40 psi			60 psi					
		Air Press.	gph	scfm	Air Press.	gph	scfm	Air Press.	gph	scfm	Air Press.	gph	scfm	Air Press.	gph	scfm			
SU16	Fluid Cap 2050 + Air Cap 67-6-20-70°	8.0	1.41	.36	14	2.10	.42	22	2.36	.56	30	2.53	.68	44	2.95	.81	5-1/2 - 7-1/2	9 - 12	5 - 13
		12.0	.79	.50	18	1.68	.56	30	1.61	.83	38	1.90	.94	55	2.30	1.20			
		14.0	.45	.60	20	1.44	.64	34	1.15	1.00	42	1.50	1.1	60	1.92	1.40			
		-	-	-	22	1.17	.71	36	.91	1.07	46	1.10	1.26	65	1.50	1.60			
		-	-	-	24	.91	.80	38	.68	1.16	48	.90	1.35	70	1.07	1.80			
SU26B	Fluid Cap 40100 + Air Cap 140-6-37-70°	12.0	1.85	1.78	22	3.30	2.30	30	5.10	2.54	38	6.40	2.84	54	8.76	3.44	7 - 8-1/2	12-1-1/2 - 14-1-1/2	6 - 19-1/2
		14.0	.55	2.20	24	2.20	2.67	32	4.25	2.85	42	4.70	3.42	56	8.10	3.74			
		-	-	-	26	1.20	3.05	34	3.35	3.18	44	3.90	3.72	58	7.44	4.03			
		-	-	-	-	-	-	36	2.50	3.50	46	3.06	4.05	60	6.76	4.32			
		-	-	-	-	-	-	38	1.60	3.85	48	2.25	4.42	65	5.10	5.10			
		-	-	-	-	-	-	40	.70	4.30	50	1.40	4.84	70	3.50	6.00			
		-	-	-	-	-	-	-	-	-	52	.60	5.34	75	1.85	6.95			
SU26	Fluid Cap 60100 + Air Cap 140-6-37-70°	10.0	6.3	1.14	20	9.0	1.60	30	11.2	2.04	40	12.4	2.54	56	16.2	2.75	7-1/2 - 8	14 - 15-1/2	7 - 22-1/2
		12.0	3.6	1.54	22	6.9	2.00	32	9.3	2.44	42	10.6	2.92	58	14.8	3.11			
		14.0	2.0	2.00	24	5.1	2.40	34	7.4	2.80	44	8.8	3.33	60	13.8	3.50			
		-	-	-	26	3.3	2.80	36	5.4	3.20	46	7.1	3.72	65	9.8	4.42			
		-	-	-	-	-	-	38	3.6	3.60	48	5.4	4.14	70	6.5	5.36			
		-	-	-	-	-	-	40	2.3	3.98	50	3.6	4.51	75	4.0	6.31			
		-	-	-	-	-	-	-	-	-	52	2.2	4.91	80	2.4	6.51			
SU29	Fluid Cap 60100 + Air Cap 140-6-52-70°	18.0	9.4	3.0	30	13.4	4.15	44	15.3	5.45	60	15.6	7.05	80	21.4	8.55	8 - 9-1/2	13 - 16	18 - 34
		22	7.7	3.6	34	11.9	4.65	48	13.8	5.9	70	12.5	8.25	85	19.5	9.15			
		26	6.0	4.13	38	10.3	5.1	55	11.3	6.75	80	9.3	9.45	90	17.9	9.75			
		30	4.4	4.7	46	7.3	6.1	70	6.1	8.6	90	6.2	10.7	100	15.1	10.95			
		34	3.0	5.25	60	2.4	7.95	80	3.3	9.85	100	3.7	11.9	-	-	-			

\*At the stated pressure in psi.

Drip Free™ spray set-ups ensure positive shut-off and are provided for air atomizing assemblies containing a shut-off needle. For more information, call 1.800.95.SPRAY.



**PERFORMANCE DATA:  
PRESSURE SPRAY SET-UPS | INTERNAL MIX | WIDE ANGLE ROUND SPRAY**

Spray Set-up No.	Spray Set-up Consists of Fluid and Air Cap Combination	Liquid Capacity (gallons per hour)* and Air Capacity (standard cubic feet per minute)*															Spray Dimensions		
		Liquid Pressure																	
		10 psi			20 psi			30 psi			40 psi			60 psi			A (in.)	B (in.)	C (ft.)
		Air Press.	gph	scfm	Air Press.	gph	scfm	Air Press.	gph	scfm	Air Press.	gph	scfm	Air Press.	gph	scfm			
SU30	Fluid Cap 40100 + Air Cap 120-6-35-60°	16.0	3.24	1.43	28	4.60	1.96	42	5.27	2.67	55	5.69	3.30	80	7.10	4.50	6 - 7-1/2	9 - 11	9 - 31
		20	2.08	1.75	36	2.45	2.55	48	3.45	3.11	65	3.15	4.06	90	4.65	5.27			
		24	1.30	2.06	42	1.45	3.00	55	2.11	3.63	75	1.72	4.82	100	3.00	6.03			
		28	.82	2.35	46	1.0	3.28	65	1.03	4.36	85	1.05	5.58	-	-	-			
SU46	Fluid Cap 100150 + Air Cap 189-6-62-70°	24	6.7	5.5	38	10.7	7.4	48	16.5	8.8	60	18.6	10.4	85	29.2	13.7	9-1/2 - 13	18 - 23	18 - 32
		28	4.0	6.3	44	6.2	8.7	56	9.2	10.4	70	10.0	12.4	95	20.7	15.8			
		32	2.0	7.2	48	4.0	9.5	62	5.6	11.7	80	5.5	14.5	-	-	-			
		-	-	-	50	3.0	9.9	65	4.4	12.3	85	4.0	15.5	-	-	-			
		-	-	-	52	2.4	10.3	70	2.6	13.3	90	2.5	16.6	-	-	-			

\*At the stated pressure in psi.



**PERFORMANCE DATA:  
PRESSURE SPRAY SET-UPS | INTERNAL MIX | 360° CIRCULAR SPRAY**

Liquid is supplied to this spray set-up under pressure.

Liquid and compressed air or gas are mixed internally to produce a completely atomized spray.

When ordering only a spray set-up, 3199 retainer ring and 3612 gasket must be ordered separately. These components are included in a complete air atomizing nozzle assembly.

**Please contact your sales engineer for more information.**

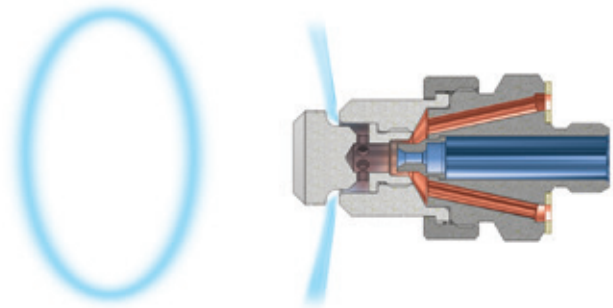

360° circular spray pattern

Spray Set-up No.	Spray Set-up Consists of Fluid and Air Cap Combination	Liquid Capacity (gallons per hour)* and Air Capacity (standard cubic feet per minute)*														
		Liquid Pressure														
		10 psi			20 psi			30 psi			40 psi			60 psi		
		Air Press.	gph	scfm	Air Press.	gph	scfm	Air Press.	gph	scfm	Air Press.	gph	scfm	Air Press.	gph	scfm
SU340C	Fluid Cap 60150 + Air Cap 189-6-62-160HC	20	4.0	2.45	34	6.6	4.09	50	7.1	6.38	60	11.0	7.6	85	14.4	11.8
		22	2.8	2.7	38	4.4	4.8	52	6.2	6.75	65	8.3	8.63	90	12.0	13.0
		24	2.0	2.97	42	2.8	5.5	56	4.4	7.55	70	6.1	9.78	95	9.8	14.1
		26	1.5	3.3	46	1.7	6.34	60	3.2	8.41	80	3.1	12.44	100	7.8	15.4
		28	1.1	3.62	48	1.3	6.85	70	1.3	11.75	90	1.4	15.4	-	-	-

\*At the stated pressure in psi.

Drip Free™ spray set-ups ensure positive shut-off and are provided for air atomizing assemblies containing a shut-off needle. For more information, call 1.800.95.SPRAY.





**PERFORMANCE DATA:  
PRESSURE SPRAY SET-UPS | INTERNAL MIX | FLAT SPRAY**

For a flat spray pattern, "A" and "B" are the pattern widths at distances from the nozzle.

The total distance of spray projection from the nozzle to the maximum dispersal point is represented by "C".

Liquid is supplied to this spray set-up under pressure.

Liquid and compressed air or gas are mixed internally to produce a completely atomized spray.

When ordering only a spray set-up, 3199 retainer ring and 3612 gasket must be ordered separately. These components are included in a complete air atomizing nozzle assembly.

**Please contact your sales engineer for more information**

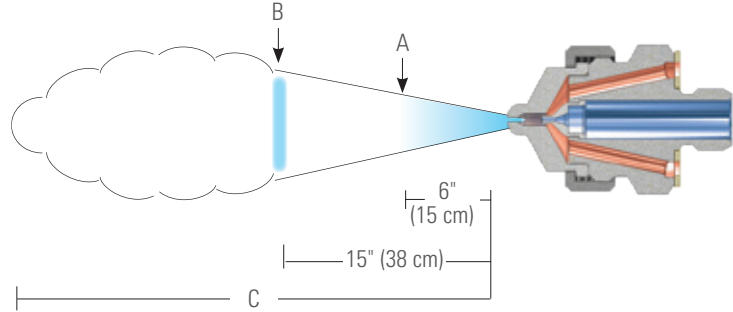

Spray Set-up No.	Spray Set-up Consists of Fluid and Air Cap Combination	Liquid Capacity (gallons per hour)* and Air Capacity (standard cubic feet per minute)*															Spray Dimensions		
		Liquid Pressure															A (in.)	B (in.)	C (ft.)
		10 psi			20 psi			30 psi			40 psi			60 psi					
Air Press.	gph	scfm	Air Press.	gph	scfm	Air Press.	gph	scfm	Air Press.	gph	scfm	Air Press.	gph	scfm	Air Press.	gph	scfm		
SU13A	Fluid Cap 2050 + Air Cap 73328	10.0	1.44	.84	18.0	2.17	1.12	28	2.49	1.47	38	2.77	1.84	55	3.41	2.43	10 - 22	18 - 37	8-1/2 - 13
		14.0	1.09	1.08	26	1.50	1.50	36	1.89	1.82	46	2.20	2.19	75	2.26	3.26			
		16.0	.93	1.20	30	1.20	1.68	40	1.58	2.00	50	1.93	2.37	85	1.69	3.67			
		20	.65	1.43	38	.68	2.07	48	1.03	2.36	65	.93	3.02	95	1.13	4.09			
		22	.53	1.55	40	.57	2.16	55	.65	2.68	70	.65	3.25	100	.88	4.29			
SU13	Fluid Cap 2850 + Air Cap 73328	12.0	2.17	.70	20	3.35	.96	30	3.98	1.27	38	4.66	1.49	65	4.8	2.38	14 - 23	28 - 38	7 - 10-1/2
		16.0	1.45	.95	28	2.06	1.34	38	2.85	1.64	46	3.6	1.85	75	3.63	2.86			
		20	.77	1.2	32	1.44	1.56	46	1.72	2.07	60	1.76	2.58	85	2.48	3.35			
		-	-	-	34	1.18	1.67	48	1.43	2.18	65	1.2	2.84	90	1.98	3.60			
		-	-	-	36	.94	1.78	50	1.2	2.28	70	.76	3.09	95	1.57	3.85			
SUN13	Fluid Cap 2850 + Air Cap 73335	16.0	2.1	1.05	26	2.8	1.38	38	2.9	1.86	44	3.8	1.99	65	4.4	2.73	4 - 8	7 - 13	10 - 16
		20	1.4	1.26	34	1.5	1.87	46	1.8	2.36	54	2.6	2.55	75	3.4	3.25			
		24	.81	1.54	38	1.2	2.1	50	1.4	2.58	60	1.9	2.98	80	3.0	3.57			
		32	.30	1.96	48	.39	2.69	70	.33	3.65	85	.40	4.27	100	2.0	4.65			
SU14	Fluid Cap 2850 + Air Cap 73320	18.0	1.04	1.05	30	1.56	1.43	42	2.06	1.75	55	2.16	2.15	75	3.20	2.66	10 - 25	18 - 38	6 - 7-1/2
		22	.62	1.25	36	.90	1.70	46	1.57	1.94	65	1.15	2.62	85	2.19	3.13			
		26	.35	1.45	40	.60	1.88	50	1.13	2.13	-	-	-	-	-	-			
		28	.25	1.55	42	.47	1.97	55	.70	2.36	-	-	-	-	-	-			
		-	-	-	44	.35	2.07	-	-	-	-	-	-	-	-	-			
SUN23	Fluid Cap 60100 + Air Cap 125340	16.0	2.9	.97	26	6.0	1.44	36	7.8	1.96	46	9.7	2.46	60	16.7	2.97	4 - 8	6 - 14	8 - 13
		20	.84	1.42	30	3.4	1.82	40	5.2	2.53	52	5.7	3.3	70	9.7	4.33			
		-	-	-	34	1.3	2.32	46	2.6	3.25	60	2.4	4.36	90	1.8	7.4			
		-	-	-	36	.80	2.61	50	1.1	3.72	65	1.1	5.04	95	.70	8.38			
SU23B	Fluid Cap 40100 + Air Cap 125328	16.0	2.95	1.92	28	4.45	2.66	38	5.94	3.22	46	7.50	3.66	65	9.70	4.80	6 - 13	8 - 19	10 - 13
		20	1.72	2.30	32	3.30	3.04	42	4.86	3.55	52	5.90	4.15	75	7.50	5.60			
		24	1.00	2.70	36	2.28	3.40	46	3.78	3.93	56	4.87	4.50	85	5.30	6.48			
		-	-	-	-	-	-	48	3.25	4.12	58	4.34	4.70	90	4.25	6.96			

\*At the stated pressure in psi.

Drip Free™ spray set-ups ensure positive shut-off and are provided for air atomizing assemblies containing a shut-off needle. For more information, call 1.800.95.SPRAY.



**PERFORMANCE DATA:  
PRESSURE SPRAY SET-UPS | INTERNAL MIX | FLAT SPRAY**

Spray Set-up No.	Spray Set-up Consists of Fluid and Air Cap Combination	Liquid Capacity (gallons per hour)* and Air Capacity (standard cubic feet per minute)*															Spray Dimensions			
		Liquid Pressure																		
		10 psi			20 psi			30 psi			40 psi			60 psi			A (in.)	B (in.)	C (ft.)	
Air Press.	gph	scfm	Air Press.	gph	scfm	Air Press.	gph	scfm	Air Press.	gph	scfm	Air Press.	gph	scfm	Air Press.	gph	scfm			
SU23	Fluid Cap 60100 + Air Cap 125328	12.0	7.0	1.15	22	11.5	1.65	34	12.4	2.20	46	13.7	2.75	65	18.3	3.56	7 - 13	12 - 20	11 - 14-1/2	
		16.0	4.2	1.57	30	6.0	2.40	42	7.8	2.95	54	8.7	3.51	80	10.6	4.95				
		20	2.7	1.97	34	4.3	2.78	48	5.0	3.52	60	6.4	4.06	90	6.9	5.85				
		22	2.0	2.20	36	3.6	2.97	50	4.3	3.71	65	4.6	4.53	95	5.5	6.30				
		-	-	-	38	3.0	3.16	52	3.7	3.90	70	3.3	5.00	100	4.5	6.76				
SU43	Fluid Cap 100150 + Air Cap 189351	14.0	7.7	3.17	26	10.5	4.55	34	20.8	4.75	42	29.4	5.15	58	44.7	6.05	7 - 14	10 - 23	11 - 17	
		16.0	5.0	3.83	28	7.0	5.15	36	16.6	5.25	44	25.1	5.6	60	41.0	6.42				
		-	-	-	-	-	-	38	12.8	5.8	46	20.8	6.05	65	31.4	7.45				
		-	-	-	-	-	-	42	6.7	6.85	50	13.1	7.15	75	15.0	10.1				
		-	-	-	-	-	-	-	-	-	52	10.0	7.75	80	8.7	11.45				
		-	-	-	-	-	-	-	-	-	54	7.3	8.3	-	-	-				

\*At the stated pressure in psi.



**PERFORMANCE DATA:  
PRESSURE SPRAY SET-UPS | INTERNAL MIX | DEFLECTED FLAT SPRAY**

Liquid is supplied to this spray set-up under pressure.

Liquid and compressed air or gas are mixed internally to produce a completely atomized spray.

When ordering only a spray set-up, 3199 retainer ring and 3612 gasket must be ordered separately. These components are included in a complete air atomizing nozzle assembly.

**Please contact your sales engineer for more information.**

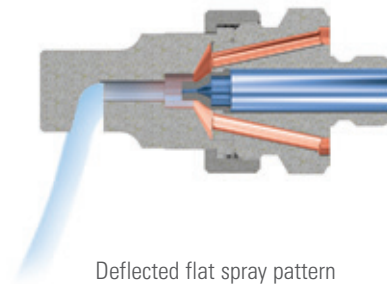

Deflected flat spray pattern

Spray Set-up No.	Spray Set-up Consists of Fluid and Air Cap Combination	Liquid Capacity (gallons per hour)* and Air Capacity (standard cubic feet per minute)*															
		Liquid Pressure															
		10 psi			20 psi			30 psi			40 psi			60 psi			
Air Press.	gph	scfm	Air Press.	gph	scfm	Air Press.	gph	scfm	Air Press.	gph	scfm	Air Press.	gph	scfm	Air Press.	gph	scfm
SU240E	Fluid Cap 28150 + Air Cap 189110-75°	6.0	2.9	1.6	14.0	3.9	2.6	22	4.7	3.3	26	5.8	3.6	38	7.4	4.6	
		8.0	2.5	1.9	16.0	3.5	2.8	24	4.3	3.6	32	4.8	4.4	46	6.4	5.5	
		10.0	2.0	2.3	18.0	3.1	3.1	26	4.0	3.8	38	3.8	5.3	54	5.3	6.6	
		12.0	1.5	2.7	20	2.8	3.5	30	3.3	4.5	44	2.8	6.2	62	4.2	7.8	
		-	-	-	22	2.3	3.8	34	2.3	5.2	46	2.3	6.6	70	2.8	9.4	

\*At the stated pressure in psi.

Drip Free™ spray set-ups ensure positive shut-off and are provided for air atomizing assemblies containing a shut-off needle. For more information, call 1.800.95.SPRAY.





**PERFORMANCE DATA:  
PRESSURE SPRAY SET-UPS | EXTERNAL MIX | FLAT SPRAY**

For a flat spray pattern, "A" and "B" are the pattern widths at distances from the nozzle.

The total distance of spray projection from the nozzle to the maximum dispersal point is represented by "C".

Liquid is supplied to this spray set-up under pressure.

The liquid and compressed air or gas are mixed externally to produce a completely atomized spray.

For external mix spray set-ups, atomization can be controlled by varying the air pressure without changing liquid flow rate.

When ordering only a spray set-up, 3199 retainer ring and 3612 gasket must be ordered separately. These components are included in a complete air atomizing nozzle assembly.

**Please contact your sales engineer for more information.**

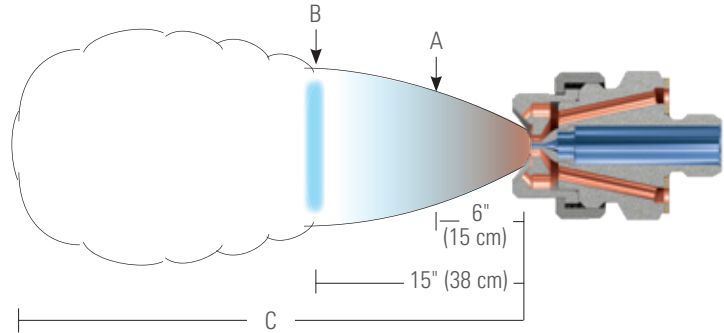

Spray Set-up No.	Spray Set-up Consists of Fluid and Air Cap Combination	Liquid Capacity (gallons per hour)* and Air Capacity (standard cubic feet per minute)*														Spray Dimensions			
		Liquid Pressure														A (in.)	B (in.)	C (ft.)	
		3 psi			5 psi			10 psi			20 psi			40 psi					
Air Press.	gph	scfm	Air Press.	gph	scfm	Air Press.	gph	scfm	Air Press.	gph	scfm	Air Press.	gph	scfm	Air Press.	gph	scfm		
SUE15B	Fluid Cap 1650 + Air Cap 67228-45°	3.0	.80	.89	5.0	1.0	.93	10.0	1.4	1.1	20	2.0	1.6	40	2.8	2.6	3-1/2 - 6	9 - 11	3 - 8
		10.0	.80	1.1	15.0	1.0	1.4	20	1.4	1.6	30	2.0	2.1	60	2.8	3.6			
		15.0	.80	1.4	20	1.0	1.6	25	1.4	1.9	40	2.0	2.6	70	2.8	4.2			
		20	.80	1.6	25	1.0	1.9	30	1.4	2.1	50	2.0	3.0	75	2.8	4.5			
		30	.80	2.1	40	1.0	2.6	50	1.4	3.0	80	2.0	4.9	90	2.8	5.6			
SUE18B	Fluid Cap 1650 + Air Cap 62240-60°	5.0	.80	.78	5.0	1.0	.78	6.0	1.4	.88	8.0	2.0	1.0	10.0	2.8	1.2	8 - 12	13 - 20	4 - 9
		6.0	.80	.88	6.0	1.0	.88	8.0	1.4	1.0	10.0	2.0	1.2	15.0	2.8	1.6			
		7.0	.80	.97	8.0	1.0	1.0	10.0	1.4	1.2	15.0	2.0	1.6	25	2.8	2.2			
		8.0	.80	1.0	10.0	1.0	1.2	12.0	1.4	1.4	20	2.0	1.9	35	2.8	2.8			
SUE15A	Fluid Cap 2050 + Air Cap 67228-45°	5.0	1.2	.93	10.0	1.6	1.1	15.0	2.2	1.4	25	3.1	1.9	45	4.4	2.9	3 - 6	8-1/2 - 12	3-1/2 - 10
		15.0	1.2	1.4	20	1.6	1.6	25	2.2	1.9	40	3.1	2.6	60	4.4	3.6			
		25	1.2	1.9	30	1.6	2.1	40	2.2	2.6	60	3.1	3.6	75	4.4	4.5			
		30	1.2	2.1	40	1.6	2.6	50	2.2	3.0	70	3.1	4.2	90	4.4	5.6			
SUE18A	Fluid Cap 2050 + Air Cap 62240-60°	5.0	1.2	.78	5.0	1.6	.78	8.0	2.2	1.0	10.0	3.1	1.2	15.0	4.4	1.6	11 - 16	16 - 26	5 - 10
		8.0	1.2	1.0	10.0	1.6	1.2	10.0	2.2	1.2	20	3.1	1.9	20	4.4	1.9			
		10.0	1.2	1.2	15.0	1.6	1.6	20	2.2	1.9	30	3.1	2.5	30	4.4	2.5			
		15.0	1.2	1.6	20	1.6	1.9	30	2.2	2.5	35	3.1	2.8	35	4.4	2.8			
SUE15	Fluid Cap 2850 + Air Cap 67228-45°	10.0	2.3	1.1	15.0	3.0	1.4	20	4.2	1.6	35	6.0	2.4	50	8.4	3.0	5 - 6-1/2	9-1/2 - 14	4 - 13
		20	2.3	1.6	25	3.0	1.9	30	4.2	2.1	50	6.0	3.0	70	8.4	4.2			
		30	2.3	2.1	40	3.0	2.6	50	4.2	3.0	70	6.0	4.2	80	8.4	4.9			
		40	2.3	2.6	50	3.0	3.0	60	4.2	3.6	80	6.0	4.9	90	8.4	5.6			
		50	2.3	3.0	60	3.0	3.6	70	4.2	4.2	90	6.0	5.6	100	8.4	6.2			

\*At the stated pressure in psi.

Anti-bearding set-ups are available to reduce nozzle build-up and maintenance time for select external mix air atomizing nozzles. Drip Free™ spray set-ups ensure positive shut-off and are provided for air atomizing assemblies containing a shut-off needle. For more information, call 1.800.95.SPRAY.



**PERFORMANCE DATA:  
PRESSURE SPRAY SET-UPS | EXTERNAL MIX | FLAT SPRAY**

Spray Set-up No.	Spray Set-up Consists of Fluid and Air Cap Combination	Liquid Capacity (gallons per hour)* and Air Capacity (standard cubic feet per minute)*															Spray Dimensions		
		Liquid Pressure																	
		3 psi			5 psi			10 psi			20 psi			40 psi			A (in.)	B (in.)	C (ft.)
		Air Press.	gph	scfm	Air Press.	gph	scfm	Air Press.	gph	scfm	Air Press.	gph	scfm	Air Press.	gph	scfm			
SUE18	Fluid Cap 2850 + Air Cap 62240-60°	6.0	2.3	.88	6.0	3.0	.88	6.0	4.2	.88	10.0	6.0	1.2	20	8.4	1.9	14 - 16	24 - 27	6 - 9-1/2
		7.0	2.3	.97	8.0	3.0	1.0	8.0	4.2	1.0	12.0	6.0	1.4	25	8.4	2.2			
		8.0	2.3	1.0	9.0	3.0	1.1	10.0	4.2	1.2	15.0	6.0	1.6	30	8.4	2.5			
		10.0	2.3	1.2	10.0	3.0	1.2	12.0	4.2	1.4	20	6.0	1.9	35	8.4	2.8			
SUE25B	Fluid Cap 35100 + Air Cap 134255-45°	10.0	3.6	3.0	15.0	4.7	3.6	20	6.6	4.1	35	9.4	6.3	45	13.2	7.5	5 - 6-1/2	10 - 14-1/2	5-1/2 - 16
		20	3.6	4.1	25	4.7	4.9	30	6.6	5.5	50	9.4	8.0	55	13.2	9.0			
		30	3.6	5.5	40	4.7	6.9	40	6.6	6.9	70	9.4	11.0	70	13.2	11.1			
		40	3.6	6.9	50	4.7	8.0	50	6.6	8.0	80	9.4	12.7	80	13.2	12.7			
		50	3.6	8.0	60	4.7	9.4	60	6.6	9.4	90	9.4	14.5	90	13.2	14.5			
SUE28B	Fluid Cap 35100 + Air Cap 122281-60°	8.0	3.6	3.2	10.0	4.7	3.6	20	6.6	5.5	30	9.4	7.4	45	13.2	10.0	13 - 15	19 - 28	12-1/2 - 16
		10.0	3.6	3.6	15.0	4.7	4.6	30	6.6	7.4	40	9.4	9.1	60	13.2	12.6			
		15.0	3.6	4.6	25	4.7	6.5	35	6.6	8.3	50	9.4	10.9	75	13.2	15.2			
		20	3.6	5.5	30	4.7	7.4	40	6.6	9.1	60	9.4	12.6	80	13.2	16.0			
SUE25A	Fluid Cap 40100 + Air Cap 134255-45°	10.0	4.8	3.0	20	6.1	4.1	25	8.7	4.9	40	12.3	6.9	50	17.4	8.2	6 - 7	10-1/2 - 14-1/2	7 - 19
		20	4.8	4.1	30	6.1	5.5	35	8.7	6.3	50	12.3	8.0	70	17.4	11.1			
		30	4.8	5.5	40	6.1	6.9	50	8.7	8.0	70	12.3	11.0	80	17.4	12.7			
		40	4.8	6.9	50	6.1	8.0	60	8.7	9.4	80	12.3	12.7	90	17.4	14.5			
		50	4.8	8.0	60	6.1	9.4	70	8.7	11.0	90	12.3	14.5	95	17.4	15.1			
SUE28A	Fluid Cap 40100 + Air Cap 122281-60°	8.0	4.8	3.2	10.0	6.1	3.6	15.0	8.7	4.6	35	12.3	8.3	50	17.4	10.9	12 - 15	20 - 25	10 - 17
		15.0	4.8	4.6	20	6.1	5.5	25	8.7	6.5	45	12.3	10.0	65	17.4	13.5			
		20	4.8	5.5	25	6.1	6.5	35	8.7	8.3	55	12.3	11.7	85	17.4	16.8			
		25	4.8	6.5	30	6.1	7.4	40	8.7	9.1	60	12.3	12.6	95	17.4	18.5			
SUE28	Fluid Cap 60100 + Air Cap 122281-60°	15.0	9.9	4.6	20	12.7	5.5	30	18.0	7.4	50	25.5	10.9	85	36.0	16.8	15 - 19	26 - 33	12 - 19
		20	9.9	5.5	30	12.7	7.4	40	18.0	9.1	70	25.5	14.3	95	36.0	18.5			
		25	9.9	6.5	35	12.7	8.3	45	18.0	10.0	80	25.5	16.0	100	36.0	19.4			
SUE25	Fluid Cap 60100 + Air Cap 134255-45°	20	9.9	4.1	30	12.7	5.5	40	18.0	6.9	50	25.5	8.0	60	36.0	9.7	6 - 8	10 - 15-1/2	9 - 19-1/2
		30	9.9	5.5	40	12.7	6.9	50	18.0	8.0	60	25.5	9.4	70	36.0	11.1			
		40	9.9	6.9	50	12.7	8.0	70	18.0	11.0	80	25.5	12.7	90	36.0	14.5			
		50	9.9	8.0	60	12.7	9.4	80	18.0	12.7	90	25.5	14.5	100	36.0	16.0			
		60	9.9	9.2	70	12.7	10.6	90	18.0	14.5	100	25.5	16.0	110	36.0	17.4			
SUE45B	Fluid Cap 60150 + Air Cap 200278-45°	30	10.0	9.2	30	12.9	9.2	40	18.0	11.6	60	25.5	15.7	-	-	-	6 - 6-1/2	11-1/2 - 13-1/2	10 - 18
		40	10.0	11.6	40	12.9	11.6	50	18.0	13.4	70	25.5	18.4	-	-	-			
		50	10.0	13.4	50	12.9	13.4	60	18.0	15.7	80	25.5	21.2	-	-	-			
		60	10.0	15.7	60	12.9	15.7	70	18.0	18.4	90	25.5	24.2	-	-	-			
SUE45A	Fluid Cap 80150 + Air Cap 200278-45°	30	17.4	9.2	40	22.5	11.6	55	31.5	14.5	70	44.7	18.4	-	-	-	6-1/2 - 8	13-1/2 - 15	11-1/2 - 20
		40	17.4	11.6	50	22.5	13.4	65	31.5	17.0	80	44.7	21.2	-	-	-			
		50	17.4	13.4	60	22.5	15.7	75	31.5	20.0	90	44.7	24.2	-	-	-			
		60	17.4	15.7	70	22.5	18.4	80	31.5	21.2	-	-	-	-	-	-			
		70	17.4	18.4	80	22.5	21.2	90	31.5	24.2	-	-	-	-	-	-			
SUE45	Fluid Cap 100150 + Air Cap 200278-45°	40	27.9	11.6	50	36.0	13.4	65	50.6	17.0	80	72.0	21.2	-	-	-	7-1/2 - 8-1/2	14 - 16	15 - 20
		50	27.9	13.4	60	36.0	15.7	75	50.6	20.0	90	72.0	24.2	-	-	-			
		60	27.9	15.7	70	36.0	18.5	85	50.6	22.5	-	-	-	-	-	-			
		70	27.9	18.4	80	36.0	21.2	-	-	-	-	-	-	-	-	-			

\*At the stated pressure in psi.

Anti-bearding set-ups are available to reduce nozzle build-up and maintenance time for select external mix air atomizing nozzles. Drip Free™ spray set-ups ensure positive shut-off and are provided for air atomizing assemblies containing a shut-off needle. For more information, call 1.800.95.SPRAY.





**PERFORMANCE DATA:  
SIPHON/GRAVITY SPRAY SET-UPS | INTERNAL MIX | FLAT SPRAY**

For a flat spray pattern, "A" and "B" are the pattern widths at distances from the nozzle.

The total distance of spray projection from the nozzle to the maximum dispersal point is represented by "C".

Liquid is supplied to this spray set-up by either a liquid siphon or a gravity-feed.

Liquid is drawn through the feed line into the air flow where it is atomized.

When ordering only a spray set-up, 3199 retainer ring and 3612 gasket must be ordered separately. These components are included in a complete air atomizing nozzle assembly.

**Please contact your sales engineer for more information.**

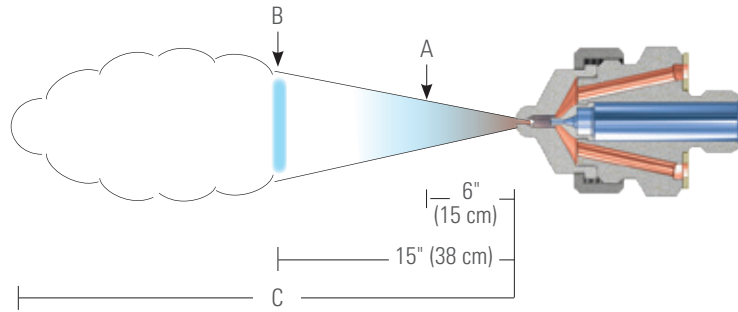

Spray Set-up No.	Spray Set-up Consists of Fluid and Air Cap Combination	Atomizing Air		Liquid Capacity (gallons per hour)*								Spray Dimensions at 8" Siphon Height		
		Air Press.	Air Capacity scfm	Gravity Head (in.)				Siphon Height (in.)				A (in.)	B (in.)	C (ft.)
				18	12	6	4	8	12	24	36			
SUF1	Fluid Cap 2850 + Air Cap 73420	10.0	.99	.35	.33	.30	.27	.25	.22	.17	.13	8 - 9	15	6 - 7
		20	1.42	.31	.30	.29	.26	.25	.23	.19	.16			
		30	1.83	.18	.16	.15	.11	.09	-	-	-			
SUF2C	Fluid Cap 35100 + Air Cap 120432	20	1.86	1.01	.95	.90	.77	.72	.67	.62	.56	9 - 11	15 - 19	9 - 10
		30	2.42	.88	.84	.81	.75	.71	.67	.63	.57			
		40	2.96	.76	.73	.69	.65	.61	.58	.53	.48			
		60	4.05	.44	.41	.37	.33	.30	.27	-	-			
SUF3B	Fluid Cap 40100 + Air Cap 122435	20	2.26	1.35	1.28	1.20	1.01	.96	.92	.78	.62	7-1/2 - 8-1/2	10-1/2 - 12	10 - 11
		30	2.88	1.26	1.21	1.14	.92	.87	.82	.74	.59			
		40	3.52	.98	.92	.87	.66	.59	.52	.44	-			
		50	4.13	.58	.52	.44	-	-	-	-	-			
SUF4B	Fluid Cap 40100 + Air Cap 122440	20	2.10	2.01	1.90	1.71	1.47	1.40	1.32	1.17	.92	6-1/2 - 8	10-1/2 - 13	11
		30	2.70	2.00	1.94	1.81	1.58	1.52	1.45	1.34	1.11			
		40	3.28	1.82	1.74	1.63	1.42	1.34	1.22	1.03	-			
		50	3.87	1.10	.97	.85	.69	-	-	-	-			

\*At the stated pressure in psi.

Drip Free™ spray set-ups ensure positive shut-off and are provided for air atomizing assemblies containing a shut-off needle. For more information, call 1.800.95.SPRAY.







PERFORMANCE DATA:  
SIPHON/GRAVITY SPRAY SET-UPS | EXTERNAL MIX | ROUND SPRAY

For a round spray pattern, angle "A" is maintained throughout distance "B". Beyond "B", the spray becomes turbulent and projects out to distance "C".

Liquid is supplied to this spray set-up by either a liquid siphon or a gravity-feed.

Liquid is drawn through the feed line into the air flow where it is atomized.

When ordering only a spray set-up, 3199 retainer ring and 3612 gasket must be ordered separately. These components are included in a complete air atomizing nozzle assembly.

**Please contact your sales engineer for more information.**

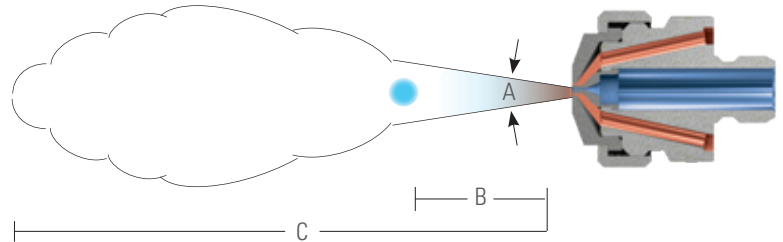

Spray Set-up No.	Spray Set-up Consists of Fluid and Air Cap Combination	Atomizing Air		Liquid Capacity (gallons per hour)*								Spray Dimensions at 8" Siphon Height		
		Air Press.	Air Capacity scfm	Gravity Head (in.)			Siphon Height (in.)					Spray Angle A (°)	B (in.)	C (ft.)
				18	12	6	4	8	12	24	36			
SU1A	Fluid Cap 1650 + Air Cap 64	10.0	.40	.39	.35	.30	.23	.18	.14	—	—	18	11 - 14	6 - 8-1/2
		20	.59	.46	.43	.39	.34	.31	.28	.14	—			
		40	.95	.54	.50	.47	.41	.38	.36	.28	.19			
		60	1.32	.59	.54	.49	.44	.41	.39	.31	.24			
SU1	Fluid Cap 2050 + Air Cap 64	10.0	.47	.63	.55	.46	.40	.32	.21	—	—	18 - 19	12 - 17	7 - 10
		20	.66	.73	.66	.60	.54	.48	.40	.21	.07			
		40	1.06	.87	.81	.76	.71	.67	.61	.43	.28			
		60	1.48	.98	.92	.88	.83	.79	.73	.57	.40			
SU2A	Fluid Cap 2050 + Air Cap 70	10.0	.81	.67	.61	.53	.43	.37	.29	—	—	18 - 20	12 - 17	8 - 13
		20	1.20	.76	.72	.64	.56	.50	.44	.21	—			
		40	1.94	.89	.86	.82	.76	.71	.65	.46	.30			
		60	2.70	.98	.96	.94	.91	.87	.81	.68	.56			
SU2	Fluid Cap 2850 + Air Cap 70	10.0	.68	1.19	1.05	.91	.56	.47	.38	—	—	21 - 22	15 - 20	10 - 15
		20	1.03	1.37	1.27	1.13	.88	.77	.68	.46	—			
		40	1.70	1.57	1.47	1.32	1.15	1.05	.91	.63	.28			
		60	2.39	1.48	1.41	1.30	1.08	1.02	.90	.74	.52			
SU4	Fluid Cap 60100 + Air Cap 120	20	1.90	5.80	5.15	4.20	3.10	2.65	1.90	.60	—	17 - 19	18 - 23	12 - 18
		40	3.00	6.50	5.95	5.10	4.30	3.70	3.00	1.55	.70			
		60	4.10	6.80	6.35	5.60	4.90	4.20	3.45	2.20	1.30			
		80	5.20	6.80	6.40	5.80	5.20	4.50	3.85	2.60	1.60			
SU5	Fluid Cap 100150 + Air Cap 180	30	5.3	—	—	—	7.2	6.0	4.6	—	—	20 - 22	20 - 25	22 - 27
		40	6.5	—	—	—	7.8	6.8	5.3	—	—			
		60	8.8	—	11.4	10.6	8.3	7.4	6.2	3.2	—			
		80	11.1	11.6	11.0	10.3	8.3	7.5	6.4	4.4	2.2			

\*At the stated pressure in psi.

Anti-bearding set-ups are available to reduce nozzle build-up and maintenance time for select external mix air atomizing nozzles. Drip Free™ spray set-ups ensure positive shut-off and are provided for air atomizing assemblies containing a shut-off needle. For more information, call 1.800.95.SPRAY.



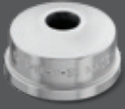

**PERFORMANCE DATA:  
SIPHON/GRAVITY SPRAY SET-UPS | EXTERNAL MIX | WIDE ANGLE ROUND SPRAY**

For this wide angle round spray pattern, angle "A" is maintained throughout distance "B". Beyond "B", the spray becomes turbulent and projects out to distance "C".

Liquid is supplied to this spray set-up by either a liquid siphon or a gravity-feed.

Liquid is drawn through the feed line into the air flow where it is atomized.

**Please contact your sales engineer for more information.**

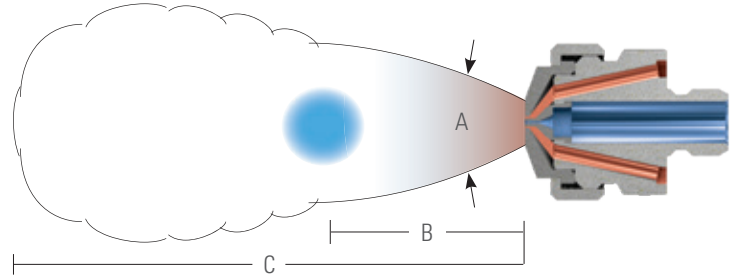

Spray Set-up No.	Atomizing Air		Liquid Capacity (gallons per hour)*							Spray Dimensions at 8" Siphon Height		
	Air Press.	Air Capacity scfm	Gravity Head (in.)			Siphon Height (in.)				Spray Angle A (°)	B (in.)	C (ft.)
			18	12	6	4	8	12	16			
D-SU1A-W D-SU1A-W-CO	7	1.21	.48	.48	.32	.32	.32	.32	.16	30 - 40	4 - 10	6 - 7
	10	1.53	.48	.48	.48	.48	.32	.32	.32			
	15	1.90	.63	.48	.48	.48	.48	.48	.48			
	22	2.60	.63	.63	.63	.63	.63	.63	.63			
D-SU1-W D-SU1-W-CO	7	1.69	.63	.63	.63	.48	.48	.48	.32	32 - 40	6 - 12	6 - 8
	10	2.06	.79	.79	.63	.63	.63	.63	.48			
	15	2.60	.95	.79	.79	.79	.79	.79	.63			
	22	3.47	1.11	.95	.95	.95	.95	.95	.79			
D-SU2A-W D-SU2A-W-CO	7	1.69	.63	.63	.63	.63	.48	.48	.32	30 - 40	6 - 12	6 - 9
	10	2.06	.79	.79	.79	.63	.63	.63	.48			
	15	2.60	.95	.95	.79	.79	.79	.79	.63			
	22	3.47	1.11	1.11	1.11	1.11	.95	.95	.95			
D-SU2-W D-SU2-W-CO	7	1.83	1.43	1.27	1.11	.95	.79	.79	.32	30 - 40	6 - 12	6 - 9
	10	2.26	1.59	1.43	1.27	1.11	1.11	.95	.63			
	15	2.87	1.74	1.59	1.43	1.27	1.27	1.27	.95			
	22	3.85	1.90	1.90	1.74	1.74	1.59	1.59	1.43			
D-SU4-W D-SU4-W-CO	7	2.15	7.13	6.50	5.55	3.17	2.54	2.06	.63	30 - 40	8 - 18	7 - 10
	10	2.66	7.45	6.97	5.86	3.80	3.17	2.69	1.43			
	15	3.36	8.24	7.45	6.50	4.60	3.80	3.49	2.22			
	22	4.49	8.88	8.40	7.45	5.55	4.76	4.12	3.01			
D-SU5-W D-SU5-W-CO	7	3.32	-	-	-	6.02	4.44	3.01	.95	30 - 40	10 - 22	7 - 11
	10	4.09	-	-	-	6.97	5.71	4.28	2.06			
	15	5.10	-	-	14.42	8.88	6.97	5.71	3.33			
	22	6.64	-	17.75	16.01	11.41	8.88	7.77	5.07			

\*At the stated pressure in psi.

"CO" set-ups are used for nozzles with clean-out needles.





**PERFORMANCE DATA:  
PRESSURE SPRAY SET-UPS | INTERNAL MIX | ROUND SPRAY**

For a round spray pattern, angle "A" is maintained throughout distance "B". Beyond "B", the spray becomes turbulent and projects out to distance "C".

Liquid is supplied to this spray set-up under pressure.

Liquid and compressed air or gas are mixed internally to produce a completely atomized spray.

When ordering only a spray set-up, 12582 retainer ring and 7717-2/007 O-ring must be ordered separately. These components are included in a complete air atomizing nozzle assembly.

**Please contact your sales engineer for more information.**

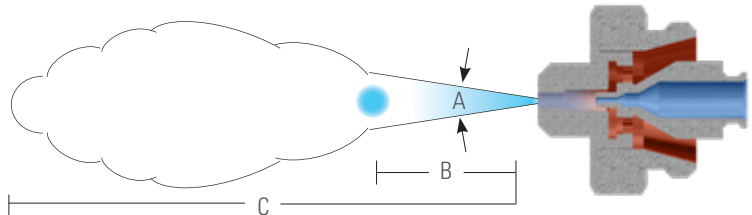

Spray Set-up No.	Spray Set-up Consists of Fluid and Air Cap Combination	Liquid Capacity (gallons per hour)* and Air Capacity (standard cubic feet per minute)*															Spray Dimensions		
		Liquid Pressure															Spray Angle A (°)	B (in.)	C (ft.)
		10 psi			20 psi			30 psi			40 psi			60 psi					
		Air Press.	gph	scfm	Air Press.	gph	scfm	Air Press.	gph	scfm	Air Press.	gph	scfm	Air Press.	gph	scfm			
SUJ11	Fluid Cap J2050 + Air Cap J67147	10.0	.66	.55	14	1.50	.40	24	1.68	.56	32	1.86	.68	50	2.28	.98	13 - 15	12 - 17-1/2	9 - 14-1/2
		12.0	.48	.67	18	1.23	.50	28	1.44	.63	36	1.62	.80	54	2.05	1.07			
		14.0	.36	.78	22	.99	.63	32	1.08	.82	40	1.32	.93	58	1.80	1.19			
		-	-	-	26	.72	.76	38	.72	1.03	48	.85	1.23	66	1.32	1.52			
		-	-	-	30	.45	.93	42	.54	1.19	52	.66	1.38	70	1.11	1.66			
SUJ12A	Fluid Cap J2050 + Air Cap J73160	10.0	.66	.66	18	1.44	.87	24	1.98	1.00	30	2.40	1.14	40	3.30	1.36	12 - 15	17 - 22	12 - 17
		12.0	.54	.77	20	1.32	.98	28	1.68	1.17	34	2.16	1.29	46	2.94	1.54			
		14.0	.42	.90	22	1.20	1.06	32	1.44	1.35	38	1.92	1.47	52	2.58	1.83			
		-	-	-	26	.90	1.26	36	1.20	1.57	44	1.50	1.78	62	2.10	2.26			
		-	-	-	-	-	-	40	1.02	1.76	48	1.32	1.98	70	1.68	2.67			
SUJ12	Fluid Cap J2850 + Air Cap J73160	12.0	1.26	.73	22	2.16	1.05	30	2.90	1.24	36	4.32	1.26	48	5.82	1.50	12 - 15	19 - 23-1/2	13 - 17-1/2
		16.0	1.08	.94	26	1.74	1.26	34	2.46	1.42	40	3.85	1.36	52	5.28	1.65			
		20	.90	1.15	30	1.44	1.47	38	2.10	1.65	44	3.55	1.56	56	4.92	1.73			
		24	.78	1.36	38	1.08	1.87	46	1.50	2.03	52	2.46	2.01	64	4.08	2.08			
		28	.76	1.56	42	.94	2.04	52	1.20	2.36	60	1.86	2.36	70	3.60	2.34			
SUJ22B	Fluid Cap J40100 + Air Cap J1401110	16.0	3.44	2.68	28	5.03	3.71	40	6.10	4.72	48	7.75	5.30	65	10.70	6.74	18 - 21	26 - 38	16 - 30
		20	2.35	3.20	32	3.70	4.17	44	5.03	5.17	55	5.95	6.07	75	8.67	7.73			
		22	1.90	3.46	36	2.64	4.65	48	3.95	5.65	65	3.55	7.28	80	7.65	8.25			
		26	1.23	3.97	44	1.30	5.63	60	1.56	7.12	80	1.40	9.10	90	5.64	9.40			
		30	.72	4.48	50	.76	6.36	70	.73	8.35	90	.72	10.34	100	3.62	10.60			

\*At the stated pressure in psi.

Drip Free™ spray set-ups ensure positive shut-off and are provided for air atomizing assemblies containing a shut-off needle. For more information, call 1.800.95.SPRAY.



**PERFORMANCE DATA:  
PRESSURE SPRAY SET-UPS | INTERNAL MIX | ROUND SPRAY**

Spray Set-up No.	Spray Set-up Consists of Fluid and Air Cap Combination	Liquid Capacity (gallons per hour)* and Air Capacity (standard cubic feet per minute)*															Spray Dimensions		
		Liquid Pressure																	
		10 psi			20 psi			30 psi			40 psi			60 psi			Spray Angle A (°)	B (in.)	C (ft.)
		Air Press.	gph	scfm	Air Press.	gph	scfm	Air Press.	gph	scfm	Air Press.	gph	scfm	Air Press.	gph	scfm			
SUJ22	Fluid Cap J60100 + Air Cap J1401110	12.0	8.1	2.00	20	13.6	2.55	30	16.3	3.25	38	19.5	3.74	54	25.7	4.66	17 - 21	24 - 36	16 - 28
		14.0	6.6	2.32	22	12.0	2.85	34	13.1	3.75	42	16.5	4.20	60	21.8	5.34			
		16.0	4.9	2.66	24	10.2	3.15	38	9.9	4.32	46	13.6	4.71	65	18.5	5.98			
		–	–	–	28	7.2	3.75	42	7.6	4.90	52	9.6	5.58	75	12.2	7.80			
		–	–	–	32	4.6	4.35	46	5.6	5.50	56	7.6	6.14	85	8.0	8.90			

\*At the stated pressure in psi.



**PERFORMANCE DATA:  
PRESSURE SPRAY SET-UPS | INTERNAL MIX | 360° CIRCULAR SPRAY**

Liquid is supplied to this spray set-up under pressure.

Liquid and compressed air or gas are mixed internally to produce a completely atomized spray.

When ordering only a spray set-up, 7717-2/007 O-ring must be ordered separately. This component is included in a complete air atomizing nozzle assembly.

**Please contact your sales engineer for more information.**

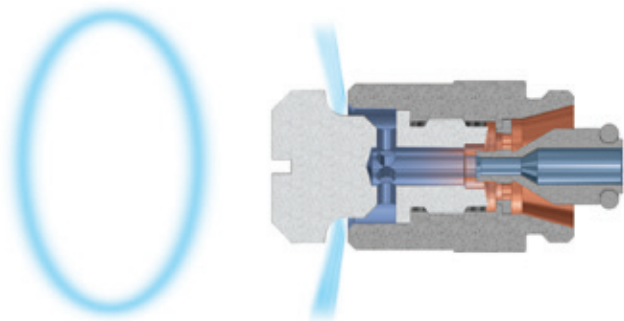

360° circular spray pattern

Spray Set-up No.	Spray Set-up Consists of Fluid and Air Cap Combination	Liquid Capacity (gallons per hour)* and Air Capacity (standard cubic feet per minute)*														
		Liquid Pressure														
		10 psi			20 psi			30 psi			40 psi			60 psi		
		Air Press.	gph	scfm	Air Press.	gph	scfm	Air Press.	gph	scfm	Air Press.	gph	scfm	Air Press.	gph	scfm
SUJ340C	Fluid Cap J60100 + Air Cap J150-6-62-160HC	20	4.0	2.45	34	6.6	4.09	50	7.1	6.38	60	11.0	7.6	85	14.4	11.8
		22	2.8	2.7	38	4.4	4.8	52	6.2	6.75	65	8.3	8.63	90	12.0	13.0
		24	2.0	2.97	42	2.8	5.5	56	4.4	7.55	70	6.1	9.78	95	9.8	14.1
		26	1.5	3.3	46	1.7	6.34	60	3.2	8.41	80	3.1	12.44	100	7.8	15.4
		28	1.1	3.62	48	1.3	6.85	70	1.3	11.75	90	1.4	15.4	–	–	–

Drip Free™ spray set-ups ensure positive shut-off and are provided for air atomizing assemblies containing a shut-off needle. For more information, call 1.800.95.SPRAY.





**PERFORMANCE DATA:  
PRESSURE SPRAY SET-UPS | INTERNAL MIX | WIDE ANGLE ROUND SPRAY**

For a wide angle round spray, dimensions “A” and “B” are the pattern widths at distances from the nozzle.

The total distance of spray projection from the nozzle to the maximum dispersal point is represented by “C”.

Liquid is supplied to this spray set-up under pressure.

Liquid and compressed air or gas are mixed internally to produce a completely atomized spray.

When ordering only a spray set-up, 12582 retainer ring and 7717-2/007 O-ring must be ordered separately. These components are included in a complete air atomizing nozzle assembly.

**Please contact your sales engineer for more information.**

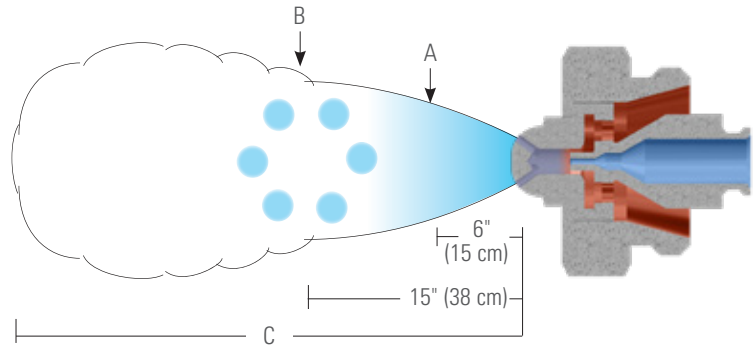

Spray Set-up No.	Spray Set-up Consists of Fluid and Air Cap Combination	Liquid Capacity (gallons per hour)* and Air Capacity (standard cubic feet per minute)*															Spray Dimensions		
		Liquid Pressure															A (in.)	B (in.)	C (ft.)
		10 psi			20 psi			30 psi			40 psi			60 psi					
		Air Press.	gph	scfm	Air Press.	gph	scfm	Air Press.	gph	scfm	Air Press.	gph	scfm	Air Press.	gph	scfm			
SUJ16	Fluid Cap J2050 + Air Cap J67-6-20-70°	8.0	1.41	.36	14.0	2.10	.42	22	2.36	.56	30	2.53	.68	44	2.95	.81	5-1/2 - 7-1/2	9 - 12	5 - 13
		10.0	1.14	.43	16.0	1.90	.50	26	2.02	.69	34	2.23	.81	48	2.72	.94			
		14.0	.45	.60	22	1.17	.71	36	.91	1.07	46	1.10	1.26	65	1.50	1.60			
		—	—	—	26	.55	.90	40	.43	1.25	50	.69	1.45	75	.65	2.05			
SUJ26B	Fluid Cap J40100 + Air Cap J140-6-37-70°	12.0	1.85	1.78	22	3.30	2.30	30	5.10	2.54	38	6.40	2.84	54	8.76	3.44	7 - 8-1/2	12-1/2 - 14-1/2	6 - 19-1/2
		14.0	.55	2.20	24	2.20	2.67	32	4.25	2.85	42	4.70	3.42	56	8.10	3.74			
		—	—	—	26	1.20	3.05	36	2.50	3.50	46	3.06	4.05	60	6.76	4.32			
		—	—	—	—	—	—	40	.70	4.30	50	1.40	4.84	70	3.50	6.00			
SUJ26	Fluid Cap J60100 + Air Cap J140-6-37-70°	10.0	6.3	1.14	20	9.0	1.60	30	11.2	2.04	40	12.4	2.54	56	16.2	2.75	7-1/2 - 8	14 - 15-1/2	7 - 22-1/2
		12.0	3.6	1.54	22	6.9	2.00	32	9.3	2.44	42	10.6	2.92	58	14.8	3.11			
		14.0	2.0	2.00	24	5.1	2.40	36	5.4	3.20	46	7.1	3.72	65	9.8	4.42			
		—	—	—	26	3.3	2.80	40	2.3	3.98	50	3.6	4.51	75	4.0	6.31			
		—	—	—	—	—	—	—	—	—	52	2.2	4.91	80	2.4	6.51			
SUJ29	Fluid Cap J60100 + Air Cap J140-6-52-70°	18.0	9.4	3.0	30	13.4	4.15	44	15.3	5.45	60	15.6	7.05	80	21.4	8.55	8 - 9-1/2	13 - 16	18 - 34
		26	6.0	4.13	38	10.3	5.1	55	11.3	6.75	80	9.3	9.45	90	17.9	9.75			
		34	3.0	5.25	60	2.4	7.95	80	3.3	9.85	100	3.7	11.9	—	—	—			
SUJ30	Fluid Cap J40100 + Air Cap J120-6-35-60°	16.0	3.24	1.43	28	4.60	1.96	42	5.27	2.67	55	5.69	3.30	80	7.10	4.50	6 - 7-1/2	9 - 11	9 - 31
		20	2.08	1.75	36	2.45	2.55	48	3.45	3.11	65	3.15	4.06	90	4.65	5.27			
		28	.82	2.35	46	1.0	3.28	65	1.03	4.36	85	1.05	5.58	—	—	—			

\*At the stated pressure in psi.

Drip Free™ spray set-ups ensure positive shut-off and are provided for air atomizing assemblies containing a shut-off needle. For more information, call 1.800.95.SPRAY.





**PERFORMANCE DATA:  
PRESSURE SPRAY SET-UPS | INTERNAL MIX | FLAT SPRAY**

For a flat spray pattern, "A" and "B" are the pattern widths at distances from the nozzle.

The total distance of spray projection from the nozzle to the maximum dispersal point is represented by "C".

Liquid is supplied to this spray set-up under pressure.

Liquid and compressed air or gas are mixed internally to produce a completely atomized spray.

When ordering only a spray set-up, 12582 retainer ring and 7717-2/007 O-ring must be ordered separately. These components are included in a complete air atomizing nozzle assembly.

**Please contact your sales engineer for more information.**

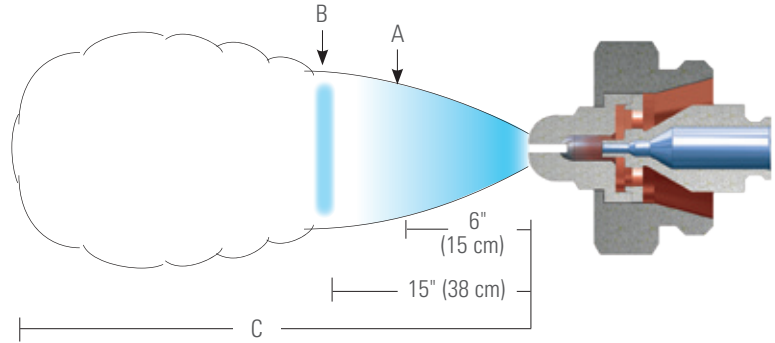

Spray Set-up No.	Spray Set-up Consists of Fluid and Air Cap Combination	Liquid Capacity (gallons per hour)* and Air Capacity (standard cubic feet per minute)*															Spray Dimensions		
		Liquid Pressure															A (in.)	B (in.)	C (ft.)
		10 psi			20 psi			30 psi			40 psi			60 psi					
		Air Press.	gph	scfm	Air Press.	gph	scfm	Air Press.	gph	scfm	Air Press.	gph	scfm	Air Press.	gph	scfm			
SUJ13A	Fluid Cap J2050 + Air Cap J73328	10.0	1.44	.84	18.0	2.17	1.12	28	2.49	1.47	38	2.77	1.84	55	3.41	2.43	10 - 22	18 - 37	8-1/2 - 13
		14.0	1.09	1.08	26	1.50	1.50	36	1.89	1.82	46	2.20	2.19	75	2.26	3.26			
		22	.53	1.55	40	.57	2.16	55	.65	2.68	70	.65	3.25	100	.88	4.29			
SUJ13	Fluid Cap J2850 + Air Cap J73328	12.0	2.17	.70	20	3.35	.96	30	3.98	1.27	38	4.66	1.49	65	4.8	2.38	14 - 23	28 - 38	7 - 10-1/2
		16.0	1.45	.95	28	2.06	1.34	38	2.85	1.64	46	3.6	1.85	75	3.63	2.86			
		-	-	-	36	.94	1.78	50	1.2	2.28	70	.76	3.09	95	1.57	3.85			
SUJ14	Fluid Cap J2850 + Air Cap J73320	18.0	1.04	1.05	30	1.56	1.43	42	2.06	1.75	55	2.16	2.15	75	3.20	2.66	10 - 25	18 - 38	6 - 7-1/2
		22	.62	1.25	36	.90	1.70	46	1.57	1.94	65	1.15	2.62	85	2.19	3.13			
		26	.35	1.45	40	.60	1.88	50	1.13	2.13	-	-	-	-	-	-			
		-	-	-	44	.35	2.07	-	-	-	-	-	-	-	-	-			
SUJ23B	Fluid Cap J40100 + Air Cap J125328	16.0	2.95	1.92	28	4.45	2.66	38	5.94	3.22	46	7.50	3.66	65	9.70	4.80	6 - 13	8 - 19	10 - 13
		18.0	2.25	2.10	30	3.87	2.84	40	5.40	3.40	50	6.45	3.97	70	8.60	5.20			
		20	1.72	2.30	32	3.30	3.04	42	4.86	3.55	52	5.90	4.15	75	7.50	5.60			
		24	1.00	2.70	36	2.28	3.40	46	3.78	3.93	56	4.87	4.50	85	5.30	6.48			
		-	-	-	-	-	-	-	-	-	60	3.84	4.90	-	-	-			
SUJ23	Fluid Cap J60100 + Air Cap J125328	12.0	7.0	1.15	22	11.5	1.65	34	12.4	2.20	46	13.7	2.75	65	18.3	3.56	7 - 13	12 - 20	11 - 14-1/2
		14.0	5.4	1.35	26	8.3	2.02	38	9.8	2.57	50	10.9	3.14	75	12.6	4.47			
		16.0	4.2	1.57	30	6.0	2.40	42	7.8	2.95	54	8.7	3.51	80	10.6	4.95			
		20	2.7	1.97	34	4.3	2.78	48	5.0	3.52	60	6.4	4.06	90	6.9	5.85			
		-	-	-	38	3.0	3.16	52	3.7	3.90	70	3.3	5.00	100	4.5	6.76			

\*At the stated pressure in psi.

Drip Free™ spray set-ups ensure positive shut-off and are provided for air atomizing assemblies containing a shut-off needle. For more information, call 1.800.95.SPRAY.





**PERFORMANCE DATA:  
PRESSURE SPRAY SET-UPS | EXTERNAL MIX | FLAT SPRAY**

SUJE external mix spray set-ups offer increased ability to atomize viscous fluids and allow for greater flow capacity of finely atomized sprays.

Atomization can be controlled by varying the air pressure without changing liquid flow rate.

Liquid is supplied to this spray set-up under pressure.

Liquid and compressed air or gas are mixed externally to produce a completely atomized spray.

SUJE Series set-ups produce lower spray velocity for improved transfer and reduced misting.

Low profile design is ideal for applications where space is limited.

Very efficient use of air results in reduced air consumption costs and noise levels.

When ordering only a spray set-up, retainer ring and O-ring must be ordered separately. These components are included in a complete air atomizing nozzle assembly. The 46599 adapter is used with all 1/8JJ nozzle bodies and 1/8JJAU nozzle bodies with extensions only.

**Please contact your sales engineer for more information.**

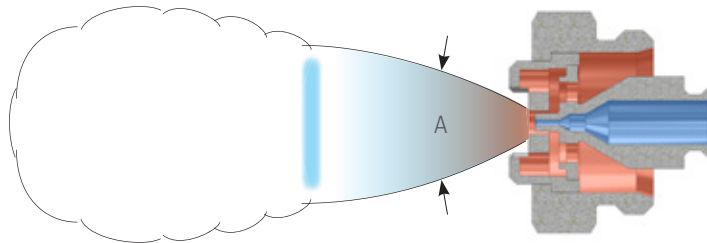

Spray Set-up No.	Spray Set-up Consists of Fluid and Air Cap Combination	Liquid Capacity (gallons per hour)* and Air Capacity (standard cubic feet per minute)*												Spray Angle A (°)
		Liquid Pressure												
		10 psi			20 psi			30 psi			40 psi			
		Air Press.	gph	scfm	Air Press.	gph	scfm	Air Press.	gph	scfm	Air Press.	gph	scfm	
SUJE416-50	Fluid Cap PFJ1650 + Air Cap PAJ105-50	10.0	1.3	2.3	10.0	1.8	2.3	10.0	2.2	2.3	10.0	2.6	2.3	50
		30	1.3	5.0	30	1.8	5.0	30	2.2	5.0	30	2.6	5.0	
		40	1.3	6.2	40	1.8	6.2	40	2.2	6.2	40	2.6	6.2	
		50	1.3	7.4	50	1.8	7.4	50	2.2	7.4	50	2.6	7.4	
SUJE417-50	Fluid Cap PFJ2050 + Air Cap PAJ105-50	10.0	1.9	2.3	10.0	2.6	2.3	10.0	3.2	2.3	10.0	–	–	
		30	1.9	5.0	30	2.6	5.0	30	3.2	5.0	30	4.0	5.0	
		50	1.9	7.4	50	2.6	7.4	50	3.2	7.4	50	4.0	7.4	
SUJE418-50	Fluid Cap PFJ2850 + Air Cap PAJ105-50	10.0	2.9	2.3	10.0	5.8	2.3	10.0	7.9	2.3	10.0	8.3	2.3	
		30	2.9	5.0	30	5.8	5.0	30	7.9	5.0	30	8.3	5.0	
		50	2.9	7.4	50	5.8	7.4	50	7.9	7.4	50	8.3	7.4	
SUJE420-50	Fluid Cap PFJ40100 + Air Cap PAJ135-50	10.0	8.0	2.3	10.0	11.7	2.3	10.0	14.4	2.3	10.0	16.7	2.3	
		30	8.0	5.0	30	11.7	5.0	30	14.4	5.0	30	16.7	5.0	
		50	8.0	7.3	50	11.7	7.3	50	14.4	7.3	50	16.7	7.3	

\*At the stated pressure in psi.

Drip Free™ spray set-ups ensure positive shut-off and are provided for air atomizing assemblies containing a shut-off needle. For more information, call 1.800.95.SPRAY.



**PERFORMANCE DATA:  
PRESSURE SPRAY SET-UPS | EXTERNAL MIX | FLAT SPRAY**

Spray Set-up No.	Spray Set-up Consists of Fluid and Air Cap Combination	Liquid Capacity (gallons per hour)* and Air Capacity (standard cubic feet per minute)*												Spray Angle A (°)
		Liquid Pressure												
		10 psi			20 psi			30 psi			40 psi			
		Air Press.	gph	scfm	Air Press.	gph	scfm	Air Press.	gph	scfm	Air Press.	gph	scfm	
SUJE416-65	Fluid Cap PFJ1650 + Air Cap PAJ080-65	10.0	1.3	1.9	10.0	1.8	1.9	10.0	2.2	1.9	10.0	2.6	1.9	65
		30	1.3	4.0	30	1.8	4.0	30	2.2	4.0	30	2.6	4.0	
		50	1.3	5.9	50	1.8	5.9	50	2.2	5.9	50	2.6	5.9	
SUJE417-65	Fluid Cap PFJ2050 + Air Cap PAJ080-65	10.0	1.9	1.9	10.0	2.6	1.9	10.0	3.2	1.9	10.0	4.0	1.9	
		30	1.9	4.0	30	2.6	4.0	30	3.2	4.0	30	4.0	4.0	
		50	1.9	5.9	50	2.6	5.9	50	3.2	5.9	50	4.0	5.9	
SUJE418-65	Fluid Cap PFJ2850 + Air Cap PAJ080-65	10.0	2.9	1.9	10.0	5.8	1.9	10.0	–	–	10.0	–	–	
		30	2.9	4.0	30	5.8	4.0	30	7.9	4.0	30	8.3	4.0	
		50	2.9	5.9	50	5.8	5.9	50	7.9	5.9	50	8.3	5.9	
SUJE420-65	Fluid Cap PFJ40100 + Air Cap PAJ125-65	10.0	8.0	2.1	10.0	11.7	2.1	10.0	14.4	2.1	10.0	16.7	2.1	
		30	8.0	4.4	30	11.7	4.4	30	14.4	4.4	30	16.7	4.4	
		50	8.0	6.5	50	11.7	6.5	50	14.4	6.5	50	16.7	6.5	
SUJE421-65	Fluid Cap PFJ60100 + Air Cap PAJ125-65	30	16.0	4.4	30	–	–	30	–	–	30	–	–	
		40	16.0	5.4	40	23.2	5.4	40	–	–	40	–	–	
		50	16.0	6.5	50	23.2	6.5	50	28.7	6.5	50	–	–	
SUJE416-90	Fluid Cap PFJ1650 + Air Cap PAJ075-90	10.0	1.3	1.9	10.0	1.8	1.9	10.0	2.2	1.9	10.0	2.6	1.9	90
		30	1.3	4.0	30	1.8	4.0	30	2.2	4.0	30	2.6	4.0	
		50	1.3	5.9	50	1.8	5.9	50	2.2	5.9	50	2.6	5.9	
SUJE417-90	Fluid Cap PFJ2050 + Air Cap PAJ075-90	10.0	1.9	1.9	10.0	2.6	1.9	10.0	3.2	1.9	10.0	4.0	1.9	
		30	1.9	4.0	30	2.6	4.0	30	3.2	4.0	30	4.0	4.0	
		50	1.9	5.9	50	2.6	5.9	50	3.2	5.9	50	4.0	5.9	
SUJE418-90	Fluid Cap PFJ2850 + Air Cap PAJ075-90	10.0	2.9	1.9	10.0	–	–	10.0	–	–	10.0	–	–	
		30	2.9	4.0	30	5.8	4.0	30	7.9	4.0	30	8.3	4.0	
		50	2.9	5.9	50	5.8	5.9	50	7.9	5.9	50	8.3	5.9	
SUJE420-90	Fluid Cap PFJ40100 + Air Cap PAJ115-90	20	8.0	2.9	20	–	–	20	–	–	20	–	–	
		30	8.0	3.9	30	11.7	3.9	30	–	–	30	–	–	
		40	8.0	4.8	40	11.7	4.8	40	14.4	4.8	40	–	–	
		50	8.0	5.7	50	11.7	5.7	50	14.4	5.7	50	16.7	5.7	
SUJE421-90	Fluid Cap PFJ60100 + Air Cap PAJ115-90	30	16.0	3.9	30	–	–	30	–	–	30	–	–	
		40	16.0	4.8	40	23.2	4.8	40	–	–	40	–	–	
		50	16.0	5.7	50	23.2	5.7	50	28.7	5.7	50	–	–	
		60	–	–	60	–	–	60	–	–	60	33.2	6.6	
		70	–	–	70	–	–	70	–	–	70	33.2	7.5	

\*At the stated pressure in psi.

Drip Free™ spray set-ups ensure positive shut-off and are provided for air atomizing assemblies containing a shut-off needle. For more information, call 1.800.95.SPRAY.







PERFORMANCE DATA:

SIPHON/GRAVITY SPRAY SET-UPS | INTERNAL MIX | FLAT SPRAY

For a flat spray pattern, “A” and “B” are the pattern widths at distances from the nozzle.

The total distance of spray projection from the nozzle to the maximum dispersal point is represented by “C”.

Liquid is supplied to this spray set-up by either a liquid siphon or a gravity-feed.

Liquid is drawn through the feed line into the air flow where it is atomized.

When ordering only a spray set-up, 12582 retainer ring and 7717-2/007 O-ring must be ordered separately. These components are included in a complete air atomizing nozzle assembly.

**Please contact your sales engineer for more information.**

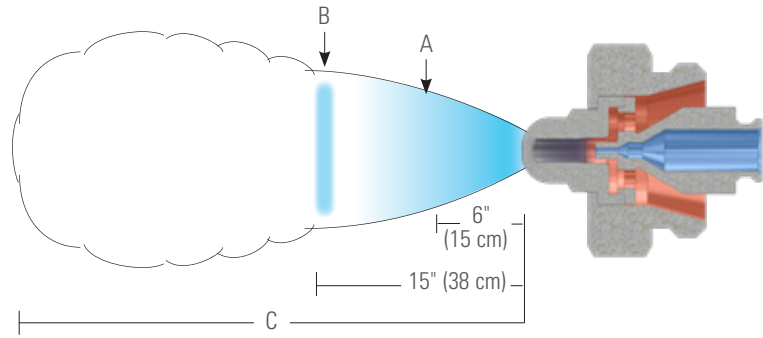

Spray Set-up No.	Spray Set-up Consists of Fluid and Air Cap Combination	Atomizing Air		Liquid Capacity (gallons per hour)*								Spray Dimensions at 8" Siphon Height		
		Air Press.	Air Capacity scfm	Gravity Head (in.)			Siphon Height (in.)					A (in.)	B (ft.)	C (ft.)
				18	12	6	4	8	12	24	36			
SUJF1	Fluid Cap J2850 + Air Cap J73420	10.0	.99	.35	.33	.30	.27	.25	.22	.17	.13	8 - 9	15	6 - 7
		20	1.42	.31	.30	.29	.26	.25	.23	.19	.16			
		30	1.83	.18	.16	.15	.11	.09	—	—	—			
SUJF2C	Fluid Cap J35100 + Air Cap J120432	20	1.86	1.01	.95	.90	.77	.72	.67	.62	.56	9 - 11	15 - 19	9 - 10
		30	2.42	.88	.84	.81	.75	.71	.67	.63	.57			
		40	2.96	.76	.73	.69	.65	.61	.58	.53	.48			
		60	4.05	.44	.41	.37	.33	.30	.27	—	—			
SUJF3B	Fluid Cap J40100 + Air Cap J122435	20	2.26	1.35	1.28	1.20	1.01	.96	.92	.78	.62	7-1/2 - 8-1/2	10 - 1/2 - 12	10 - 11
		30	2.88	1.26	1.21	1.14	.92	.87	.82	.74	.59			
		40	3.52	.98	.92	.87	.66	.59	.52	.44	—			
		50	4.13	.58	.52	.44	—	—	—	—	—			
SUJF4B	Fluid Cap J40100 + Air Cap J122440	20	2.10	2.01	1.90	1.71	1.47	1.40	1.32	1.17	.92	6-1/2 - 8	10-1/2 - 13	11
		30	2.70	2.00	1.94	1.81	1.58	1.52	1.45	1.34	1.11			
		40	3.28	1.82	1.74	1.63	1.42	1.34	1.22	1.03	—			
		50	3.87	1.10	.97	.85	.69	—	—	—	—			

\*At the stated pressure in psi.

Drip Free™ spray set-ups ensure positive shut-off and are provided for air atomizing assemblies containing a shut-off needle. For more information, call 1.800.95.SPRAY.





**PERFORMANCE DATA:  
SIPHON/GRAVITY SPRAY SET-UPS | EXTERNAL MIX | ROUND SPRAY**

For a round spray pattern, angle “A” is maintained throughout distance “B”. Beyond “B”, the spray becomes turbulent and projects out to distance “C”.

Liquid is supplied to this spray set-up by either a liquid siphon or a gravity-feed.

Liquid is drawn through the feed line into the air flow where it is atomized.

When ordering only a spray set-up, 12582 retainer ring and 7717-2/007 O-ring must be ordered separately. These components are included in a complete air atomizing nozzle assembly.

**Please contact your sales engineer for more information.**

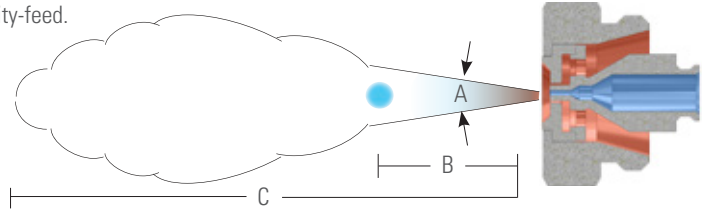

Spray Set-up No.	Spray Set-up Consists of Fluid and Air Cap Combination	Atomizing Air		Liquid Capacity (gallons per hour)*								Spray Dimensions at 8" Siphon Height		
		Air Press.	Air Capacity scfm	Gravity Head (in.)			Siphon Height (in.)					Spray Angle A (°)	B (in.)	C (ft.)
				18	12	6	4	8	12	24	36			
SUJ1A	Fluid Cap J1650 + Air Cap J64	10.0	.40	.39	.35	.30	.23	.18	.14	—	—	18	11 - 14	6 - 8-1/2
		20	.59	.46	.43	.39	.34	.31	.28	.14	—			
		40	.95	.54	.50	.47	.41	.38	.36	.28	.19			
		60	1.32	.59	.54	.49	.44	.41	.39	.31	.24			
SUJ1	Fluid Cap J2050 + Air Cap J64	10.0	.47	.63	.55	.46	.40	.32	.21	—	—	18 - 19	12 - 17	7 - 10
		20	.66	.73	.66	.60	.54	.48	.40	.21	.07			
		40	1.06	.87	.81	.76	.71	.67	.61	.43	.28			
		60	1.48	.98	.92	.88	.83	.79	.73	.57	.40			
SUJ2A	Fluid Cap J2050 + Air Cap J70	10.0	.81	.67	.61	.53	.43	.37	.29	—	—	18 - 20	12 - 17	8 - 13
		20	1.20	.76	.72	.64	.56	.50	.44	.21	—			
		40	1.94	.89	.86	.82	.76	.71	.65	.46	.30			
		60	2.70	.98	.96	.94	.91	.87	.81	.68	.56			
SUJ2	Fluid Cap J2850 + Air Cap J70	10.0	.68	1.19	1.05	.91	.56	.47	.38	—	—	21 - 22	15 - 20	10 - 15
		20	1.03	1.37	1.27	1.13	.88	.77	.68	.46	—			
		40	1.70	1.48	1.41	1.30	1.08	1.02	.90	.63	.28			
		60	2.39	1.57	1.47	1.32	1.15	1.05	.91	.74	.52			
SUJ3	Fluid Cap J2850 + Air Cap J64-5	10.0	.41	—	—	—	.59	.49	.29	—	—	18 - 19	12 - 17	8 - 13
		20	.61	—	1.22	1.05	.89	.78	.63	.26	—			
		40	.99	1.68	1.56	1.45	1.34	1.22	1.10	.70	.30			
		60	1.36	1.91	1.81	1.72	1.64	1.54	1.44	1.02	.56			
SUJ4B	Fluid Cap J40100 + Air Cap J120	10.0	1.30	—	—	—	1.40	.97	.59	—	—	17 - 19	18 - 23	10 - 15
		20	1.97	—	2.57	2.37	1.90	1.50	1.20	.34	—			
		40	3.12	3.20	2.96	2.80	2.30	2.02	1.70	.76	.26			
		60	4.28	3.47	3.24	3.05	2.57	2.32	2.05	1.16	.52			
SUJ4	Fluid Cap J60100 + Air Cap J120	20	1.90	5.80	5.15	4.20	3.10	2.65	1.90	.60	—	17 - 19	18 - 23	12 - 18
		40	3.00	6.50	5.95	5.10	4.30	3.70	3.00	1.55	.70			
		60	4.10	6.80	6.35	5.60	4.90	4.20	3.45	2.20	1.30			
		80	5.20	6.80	6.40	5.80	5.20	4.50	3.85	2.60	1.60			

\*At the stated pressure in psi.

Drip Free™ spray set-ups ensure positive shut-off and are provided for air atomizing assemblies containing a shut-off needle. For more information, call 1.800.95.SPRAY.





PERFORMANCE DATA:  
PRESSURE SPRAY SET-UPS | INTERNAL MIX | FLAT SPRAY

For a flat spray pattern, "A" and "B" are the pattern widths at distances from the nozzle.

The total distance of spray projection from the nozzle to the maximum dispersal point is represented by "C".

Liquid is supplied to this spray set-up under pressure.

Liquid and compressed air or gas are mixed internally to produce a completely atomized spray.

When ordering only a spray set-up, 1705 retainer ring and 8491 gasket must be ordered separately. These components are included in a complete air atomizing nozzle assembly.

**Please contact your sales engineer for more information.**

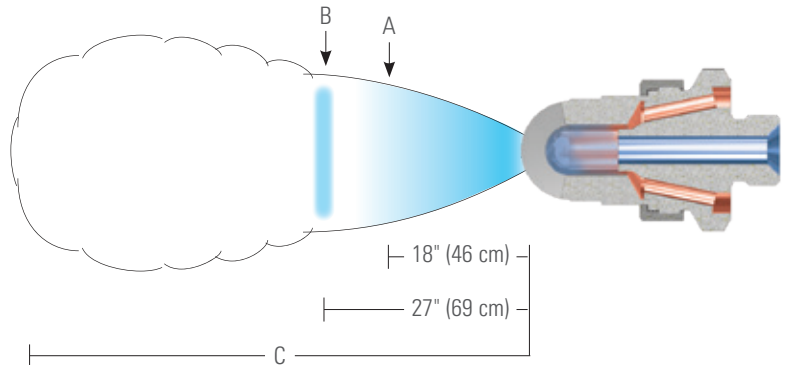

Spray Set-up No.	Spray Set-up Consists of Fluid and Air Cap Combination	Liquid Capacity (gallons per hour)* and Air Capacity (standard cubic feet per minute)*															Spray Dimensions		
		Liquid Pressure															A (in.)	B (in.)	C (ft.)
		5 psi			15 psi			25 psi			35 psi			55 psi					
		Air Press.	gph	scfm	Air Press.	gph	scfm	Air Press.	gph	scfm	Air Press.	gph	scfm	Air Press.	gph	scfm			
SU75	Fluid Cap 250375 + Air Cap 4533102	-	-	-	28	39	22.4	44	44.1	31.5	58	53	40	-	-	-	17 - 18	35 - 36	18 - 19
		-	-	-	30	31.8	24	46	37.2	33.5	60	45.6	42	-	-	-			
		-	-	-	32	24.6	25.9	48	31.2	35.1	63	38	44	-	-	-			
		-	-	-	34	19.8	27.5	50	27	36.9	65	31	47	-	-	-			
SU85	Fluid Cap 251376 + Air Cap 4693102	10.0	35.4	11.1	18.0	103	15.4	26	155	17.7	36	180	23	54	222	29.1	20 - 36	47 - 89	13 - 21
		12.0	26.4	13.4	20	81.6	17.6	28	135	20	38	162	25.4	56	198	31.2			
		-	-	-	22	63.6	19.8	30	115	22.5	40	147	27.8	58	186	34			
		-	-	-	24	49.3	22.6	32	100	25.1	42	131	30.2	60	180	36.3			
		-	-	-	-	-	-	34	84	27.5	44	116	32.6	62	166	38.9			
		-	-	-	-	-	-	36	69.5	30	46	101	35.1	64	154	41.6			
		-	-	-	-	-	-	38	56.4	32.6	48	81.5	37.6	66	142	44.1			
		-	-	-	-	-	-	40	45.7	35.3	50	75.6	40.2	68	130	46.6			
		-	-	-	-	-	-	-	-	-	52	62.4	42.7	70	119	49.3			
		-	-	-	-	-	-	-	-	-	-	-	-	72	108	51.6			
		-	-	-	-	-	-	-	-	-	-	-	-	74	97.4	54.2			
		-	-	-	-	-	-	-	-	-	-	-	-	76	87.5	57.1			

\*At the stated pressure in psi.





**PERFORMANCE DATA:  
PRESSURE SPRAY SET-UPS | INTERNAL MIX | WIDE ANGLE ROUND**

For a wide angle round spray, dimensions "A" and "B" are the pattern widths at distances from the nozzle.

The total distance of spray projection from the nozzle to the maximum dispersal point is represented by "C".

Liquid is supplied to this spray set-up under pressure.

Liquid and compressed air or gas are mixed internally to produce a completely atomized spray.

When ordering only a spray set-up, 1705 retainer ring and 8491 gasket must be ordered separately. These components are included in a complete air atomizing nozzle assembly.

**Please contact your sales engineer for more information.**

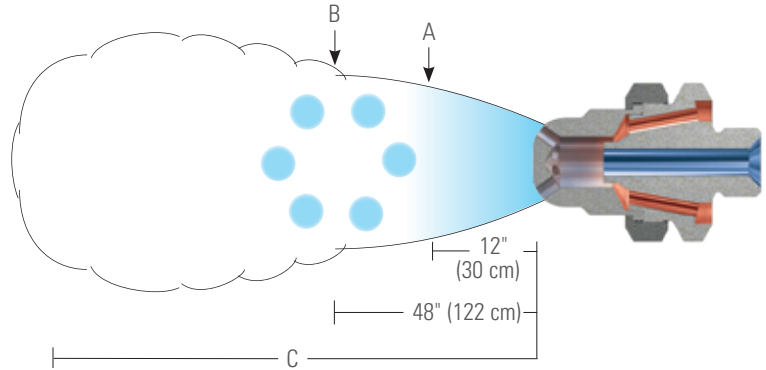

Spray Set-up No.	Spray Set-up Consists of Fluid and Air Cap Combination	Liquid Capacity (gallons per hour)* and Air Capacity (standard cubic feet per minute)*															Spray Dimensions		
		Liquid Pressure															A (in.)	B (in.)	C (ft.)
		5 psi			15 psi			25 psi			35 psi			55 psi					
		Air Press.	gph	scfm	Air Press.	gph	scfm	Air Press.	gph	scfm	Air Press.	gph	scfm	Air Press.	gph	scfm			
SU77	Fluid Cap 250375 + Air Cap 422-6-73-70°	-	-	-	-	-	-	28	33	8.4	40	28.8	11.3	58	66	12.2	13-1/2 - 14	26-1/2 - 27	22 - 28
		-	-	-	-	-	-	30	19.8	10.8	42	15.6	13.9	60	42	15.0			
		-	-	-	-	-	-	-	-	-	-	-	-	62	25.2	18.2			
SU78	Fluid Cap 250375 + Air Cap 422-6-94-70°	8.0	27	6.5	18.0	42	7.0	32	47	11.0	46	42.6	18.1	70	81	29.5	13 - 14	25-1/2 - 27	20 - 27
		10.0	15.0	8.2	20	29.4	8.8	34	36	12.8	48	32.4	20.2	75	33	34.5			
		12.0	8.4	9.8	22	20.2	10.5	36	25.2	14.7	50	25.8	22.2	80	22.2	39.6			
		-	-	-	24	14.4	12.2	38	18.6	16.6	52	19.8	24	-	-	-			
		-	-	-	-	-	-	40	13.8	18.6	54	15.6	25.8	-	-	-			
SU79	Fluid Cap 250375 + Air Cap 469-6-125-70°	10.0	34.2	11.4	26	46.2	20.2	40	62.6	27.5	54	75.6	32.6	75	127	39	13 - 14	26 - 28	23 - 30
		12.0	21.6	13.0	28	37.2	22	42	52.8	29.6	56	57	34.3	80	108	42.4			
		14.0	12.0	14.7	30	28.4	23.7	44	43.8	31.6	58	46.8	35.8	85	98	45.6			
		-	-	-	32	21.6	25.3	46	33.6	33.6	60	39	37.3	-	-	-			
		-	-	-	34	16.2	27	48	25.2	35.6	62	33	38.8	-	-	-			
SU89	Fluid Cap 251376 + Air Cap 469-6-130-70°	10.0	35.4	11.1	18.0	103	15.4	26	155	17.7	36	180	23	54	222	29.1	11 - 13	29 - 36	11 - 25
		12.0	26.4	13.4	20	81.6	17.6	28	135	20	38	162	25.4	56	198	31.2			
		-	-	-	22	63.6	19.8	30	115	22.5	40	147	27.8	58	186	34			
		-	-	-	24	49.3	22.6	32	100	25.1	42	131	30.2	60	180	36.3			
		-	-	-	-	-	-	34	84	27.5	44	116	32.6	62	166	38.9			
		-	-	-	-	-	-	36	69.5	30	46	101	35.1	64	154	41.6			
		-	-	-	-	-	-	38	56.4	32.6	48	81.5	37.6	66	142	44.1			
		-	-	-	-	-	-	40	45.7	35.3	50	75.6	40.2	68	130	46.6			
		-	-	-	-	-	-	-	-	-	52	62.4	42.7	70	119	49.3			
		-	-	-	-	-	-	-	-	-	-	-	-	72	108	51.6			
		-	-	-	-	-	-	-	-	-	-	-	-	74	97.4	54.2			
		-	-	-	-	-	-	-	-	-	-	-	-	76	87.5	57.1			

\*At the stated pressure in psi.





PERFORMANCE DATA:  
PRESSURE SPRAY SET-UPS | INTERNAL MIX | ROUND SPRAY

For a round spray, dimensions "A" and "B" are the pattern widths at distances from the nozzle.

The total distance of spray projection from the nozzle to the maximum dispersal point is represented by "C".

Liquid is supplied to this spray set-up under pressure.

Liquid and compressed air or gas are mixed internally to produce a completely atomized spray.

When ordering only a spray set-up, 1705 retainer ring and 8491 gasket must be ordered separately. These components are included in a complete air atomizing nozzle assembly.

**Please contact your sales engineer for more information.**

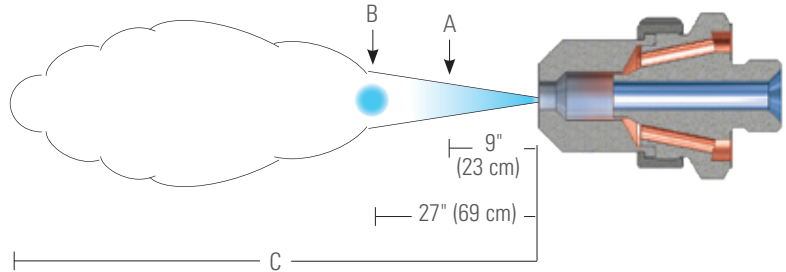

Spray Set-up No.	Spray Set-up Consists of Fluid and Air Cap Combination	Liquid Capacity (gallons per hour)* and Air Capacity (standard cubic feet per minute)*															Spray Dimensions		
		Liquid Pressure															A (in.)	B (in.)	C (ft.)
		5 psi			15 psi			25 psi			35 psi			55 psi					
		Air Press.	gph	scfm	Air Press.	gph	scfm	Air Press.	gph	scfm	Air Press.	gph	scfm	Air Press.	gph	scfm			
SU72	Fluid Cap 250375 + Air Cap 4221250	18.0	9.0	12.4	28	31.7	14.9	38	58	17.3	48	80	19.3	-	-	-	3-1/2	10	22 - 30
		20	6.7	13.7	32	22.5	17.0	44	37.7	20.8	54	55.2	23.6	-	-	-			
		22	5.4	14.7	36	15.9	19.3	50	24.7	24.8	60	40	27.5	-	-	-			
		24	4.1	15.7	38	13.2	20.4	54	19.5	27.5	66	30	32.1	-	-	-			
		-	-	-	40	11.1	21.5	58	16.0	30.2	72	23.3	37	-	-	-			
		-	-	-	42	9.2	22.6	60	14.5	31.8	78	18.3	42.2	-	-	-			
SU82	Fluid Cap 251376 + Air Cap 4691312	10.0	35.4	11.1	18.0	103	15.4	26	155	17.7	36	180	23	54	222	29.1	4 - 6	9 - 13	21 - 47
		12.0	26.4	13.4	20	81.6	17.6	28	135	20	38	162	25.4	56	198	31.2			
		-	-	-	22	63.6	19.8	30	115	22.5	40	147	27.8	58	186	34			
		-	-	-	24	49.3	22.6	32	100	25.1	42	131	30.2	60	180	36.3			
		-	-	-	-	-	-	34	84	27.5	44	116	32.6	62	166	38.9			
		-	-	-	-	-	-	36	69.5	30	46	101	35.1	64	154	41.6			
		-	-	-	-	-	-	38	56.4	32.6	48	81.5	37.6	66	142	44.1			
		-	-	-	-	-	-	40	45.7	35.3	50	75.6	40.2	68	130	46.6			
		-	-	-	-	-	-	-	-	-	52	62.4	42.7	70	119	49.3			
		-	-	-	-	-	-	-	-	-	-	-	-	72	108	51.6			
		-	-	-	-	-	-	-	-	-	-	-	-	74	97.4	54.2			
		-	-	-	-	-	-	-	-	-	-	-	-	76	87.5	57.1			

\*At the stated pressure in psi.





**PERFORMANCE DATA:  
PRESSURE SPRAY SET-UPS | INTERNAL MIX | 360° CIRCULAR SPRAY**

Liquid is supplied to this spray set-up under pressure.

Liquid and compressed air or gas are mixed internally to produce a completely atomized spray.

When ordering only a spray set-up, 3199 retainer ring and 3612 gasket must be ordered separately. These components are included in a complete air atomizing nozzle assembly.

**Please contact your sales engineer for more information.**

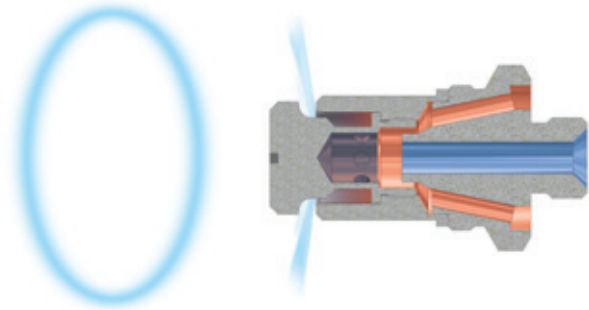

360° circular spray pattern

Spray Set-up No.	Spray Set-up Consists of Fluid and Air Cap Combination	Liquid Capacity (gallons per hour)* and Air Capacity (standard cubic feet per minute)*														
		Liquid Pressure														
		10 psi			20 psi			30 psi			40 psi			60 psi		
		Air Press.	gph	scfm	Air Press.	gph	scfm	Air Press.	gph	scfm	Air Press.	gph	scfm	Air Press.	gph	scfm
SU380C	Fluid Cap 251376 + Air Cap 469-6-130-160HC	14.0	56.4	12.2	24	104	16.0	36	116	22.4	48	122	27.8	72	128	40.2
		16.0	38.4	14.8	26	85.8	18.6	38	98.4	24.8	50	110	29.8	74	116	42.3
		18.0	25.8	16.8	28	72.6	20.3	40	85.2	26.5	52	98.4	31.5	76	108	44.3
		20	15.6	19.0	30	54.6	22.7	42	73.2	28.9	54	85.8	33.8	78	96.6	46.3
		–	–	–	32	42	24.8	44	72	30.9	56	74.4	36	80	85.8	48.3
		–	–	–	34	30.6	26.8	46	49.8	32.9	58	66	38.3	82	78.6	50.5
		–	–	–	36	24.6	29.3	48	38.4	35	60	55.2	40.1	84	67.8	52.5
		–	–	–	38	7.2	31.8	50	30	37.8	62	44.4	42	86	61.2	54.8
		–	–	–	–	–	–	–	–	–	64	37.2	44.5	90	48	59
		–	–	–	–	–	–	–	–	–	66	20.4	45.8	–	–	–

\*At the stated pressure in psi.



PERFORMANCE DATA:  
PRESSURE SPRAY SET-UPS | EXTERNAL MIX | FLAT SPRAY

For a flat spray pattern, "A" and "B" are the pattern widths at distances from the nozzle.

The total distance of spray projection from the nozzle to the maximum dispersal point is represented by "C".

Liquid is supplied to this spray set-up under pressure.

The liquid and compressed air or gas are mixed externally to produce a completely atomized spray.

For external mix spray set-ups, atomization can be controlled by varying the air pressure without changing liquid flow rate.

When ordering only a spray set-up, 1705 retainer ring and 8491 gasket must be ordered separately. These components are included in a complete air atomizing nozzle assembly.

**Please contact your sales engineer for more information.**

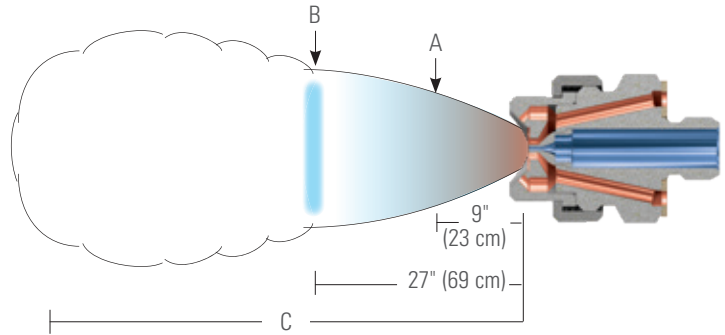

Spray Set-up No.	Spray Set-up Consists of Fluid and Air Cap Combination	Liquid Capacity (gallons per hour)* and Air Capacity (standard cubic feet per minute)*															Spray Dimensions		
		Liquid Pressure															A (in.)	B (in.)	C (ft.)
		3 psi			5 psi			7 psi			10 psi			15 psi					
		Air Press.	gph	scfm	Air Press.	gph	scfm	Air Press.	gph	scfm	Air Press.	gph	scfm	Air Press.	gph	scfm			
SUE75	Fluid Cap 250375 + Air Cap 14356	30	138	31	40	180	38	45	210	41.5	55	252	48	80	306	65	8-1/2 - 10	20-1/2 - 26	19 - 29
		35	138	34	45	180	41.5	50	210	45	60	252	51.5	85	306	69			
		40	138	38	50	180	45	55	210	48	70	252	58	90	306	72			
		45	138	41.5	55	180	48	60	210	51.5	75	252	62	95	306	75			
		-	-	-	60	180	51.5	65	210	55	80	252	65	100	306	78			
		-	-	-	-	-	-	70	210	58	85	252	69	-	-	-			

\*At the stated pressure in psi.



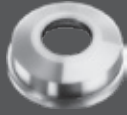

**PERFORMANCE DATA:  
SIPHON/GRAVITY SPRAY SET-UPS | EXTERNAL MIX | ROUND SPRAY**

For a round spray pattern, "A" and "B" are the pattern widths at distances from the nozzle.

The total distance of spray projection from the nozzle to the maximum dispersal point is represented by "C".

Liquid is supplied to this spray set-up by either a liquid siphon or a gravity-feed. The liquid drawn through the feed line into the air flow where it is atomized.

When ordering only a spray set-up, 5713 retainer ring must be ordered separately. This component is included in a complete air atomizing nozzle assembly.

**Please contact your sales engineer for more information.**

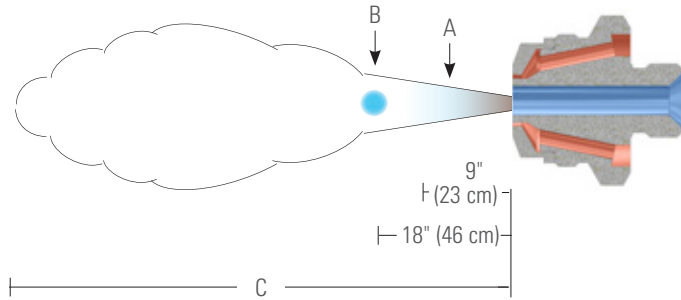

Spray Set-up No.	Spray Set-up Consists of Fluid and Air Cap Combination	Atomizing Air		Liquid Capacity (gallons per hour)*							Spray Dimensions at 8" Siphon Height		
		Air Press.	Air Capacity scfm	Gravity Head (in.)			Siphon Height (in.)				A (in.)	B (ft.)	C (ft.)
				18	12	6	4	8	12	24			
SU70	Fluid Cap 250375 + Air Cap 437	10.0	12.7	-	-	-	10.7	-	-	-	9	8	20 - 35
		20	18.5	-	-	-	22.8	13.9	-	-			
		30	24	-	-	-	32.4	24.8	13.8	-			
		40	29.2	-	67.6	58.8	38.8	31.2	22.7	-			
		50	34.8	79.8	70.5	62.8	43	35.2	27.6	-			
		60	40.1	81.9	72.1	63.5	45.4	38.3	30.5	9.5			
		70	46.1	83.2	74.5	66.0	48	41.4	33.9	13.8			
		80	51.0	84.6	76.2	67.6	49.8	43.2	36	16.5			

\*At the stated pressure in psi.







PERFORMANCE DATA:  
PRESSURE SPRAY SET-UPS | INTERNAL MIX | WIDE ANGLE ROUND SPRAY

For a wide angle round spray, dimensions "A" and "B" are the pattern widths at distances from the nozzle.

The total distance of spray projection from the nozzle to the maximum dispersal point is represented by "C".

Liquid is supplied to this spray set-up under pressure.

Liquid and compressed air or gas are mixed internally to produce a completely atomized spray.

When ordering only a spray set-up, 5713 retainer ring must be ordered separately. This component is included in a complete air atomizing nozzle assembly.

**Please contact your sales engineer for more information.**

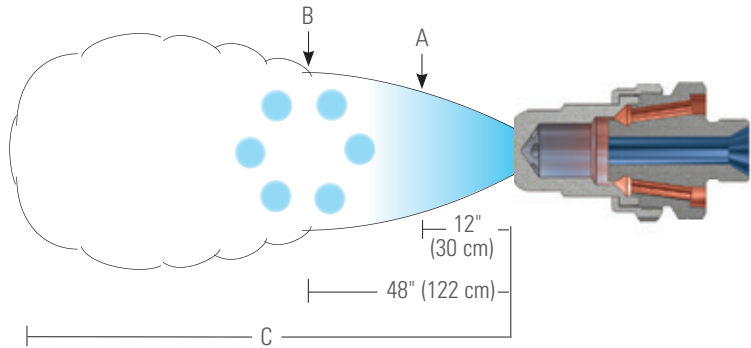

Spray Set-up No.	Spray Set-up Consists of Fluid and Air Cap Combination	Liquid Capacity (gallons per minute)* and Air Capacity (standard cubic feet per minute)*														Spray Dimensions			
		Liquid Pressure														A (in.)	B (in.)	C (ft.)	
		10 psi			20 psi			30 psi			40 psi			60 psi					
		Air Press.	gpm	scfm	Air Press.	gpm	scfm	Air Press.	gpm	scfm	Air Press.	gpm	scfm	Air Press.	gpm				scfm
SU159	Fluid Cap 4371000 + Air Cap 1109-6-224-70°	12.0	3.2	43	22	5.1	52	32	6.5	64	42	7.7	79	60	10.6	99	16 - 22	41 - 67	14 - 61
		14.0	2.4	51	24	4.1	62	34	5.5	75	44	6.7	90	62	9.5	108			
		16.0	1.7	61	26	3.3	72	36	4.5	86	46	5.7	100	64	8.4	118			
		-	-	-	28	2.6	85	38	3.6	96	48	4.9	110	66	7.5	130			
		-	-	-	30	2.0	94	40	3.1	106	50	4.2	120	68	6.8	142			
		-	-	-	32	1.6	104	42	2.6	116	52	3.6	132	70	6.1	152			
		-	-	-	-	-	-	44	2.2	128	54	3.1	140	72	5.5	166			
		-	-	-	-	-	-	46	1.8	136	56	2.7	150	74	5.0	178			
		-	-	-	-	-	-	-	-	-	58	2.3	164	76	4.5	190			

\*At the stated pressure in psi.





**PERFORMANCE DATA:  
PRESSURE SPRAY SET-UPS | INTERNAL MIX | ROUND SPRAY**

For a round spray, dimensions "A" and "B" are the pattern widths at distances from the nozzle.

The total distance of spray projection from the nozzle to the maximum dispersal point is represented by "C".

Liquid is supplied to this spray set-up under pressure.

Liquid and compressed air or gas are mixed internally to produce a completely atomized spray.

When ordering only a spray set-up, 5713 retainer ring must be ordered separately. This component is included in a complete air atomizing nozzle assembly.

**Please contact your sales engineer for more information.**

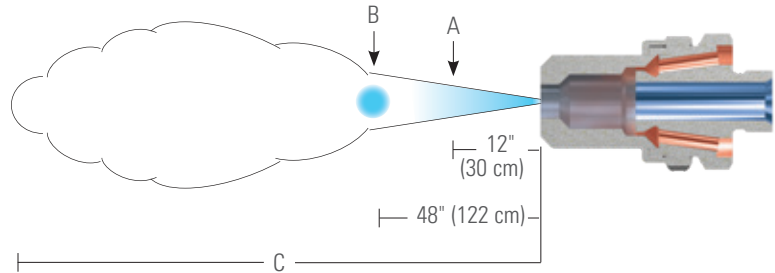

Spray Set-up No.	Spray Set-up Consists of Fluid and Air Cap Combination	Liquid Capacity (gallons per minute)* and Air Capacity (standard cubic feet per minute)*															Spray Dimensions		
		Liquid Pressure															A (in.)	B (in.)	C (ft.)
		10 psi			20 psi			30 psi			40 psi			60 psi					
		Air Press.	gpm	scfm	Air Press.	gpm	scfm	Air Press.	gpm	scfm	Air Press.	gpm	scfm	Air Press.	gpm	scfm			
SU152	Fluid Cap 4371000 + Air Cap 11091547	12.0	3.2	43	22	5.1	52	32	6.5	64	42	7.7	79	60	10.6	99	4 - 5	12 - 15	30 - 83
		14.0	2.4	51	24	4.1	62	34	5.5	75	44	6.7	90	62	9.5	108			
		16.0	1.7	61	26	3.3	72	36	4.5	86	46	5.7	100	64	8.4	118			
		-	-	-	28	2.6	85	38	3.6	96	48	4.9	110	66	7.5	130			
		-	-	-	30	2.0	94	40	3.1	106	50	4.2	120	68	6.8	142			
		-	-	-	32	1.6	104	42	2.6	116	52	3.6	132	70	6.1	152			
		-	-	-	-	-	-	44	2.2	128	54	3.1	140	72	5.5	166			
		-	-	-	-	-	-	46	1.8	136	56	2.7	150	74	5.0	178			
SU172	Fluid Cap 6251000 + Air Cap 11251625	12.0	5.92	48.5	20	11.0	42.5	30	13.2	55	40	15.1	66	60	18.3	79	6	13 - 15	25 - 50
		14.0	4.40	82	22	9.1	60	32	11.7	69	42	13.8	78	65	15.8	107			
		16.0	3.45	128	24	7.8	80	34	10.4	85	44	12.6	93	70	13.5	138			
		18.0	2.75	187	26	6.72	110	36	9.4	102	46	11.6	109	-	-	-			
		-	-	-	28	5.95	143	38	8.45	125	48	10.7	125	-	-	-			
		-	-	-	30	5.25	183	40	7.75	150	50	9.7	145	-	-	-			

\*At the stated pressure in psi.





PERFORMANCE DATA:  
PRESSURE SPRAY SET-UPS | INTERNAL MIX | FLAT SPRAY

For a flat spray pattern, "A" and "B" are the pattern widths at distances from the nozzle.

The total distance of spray projection from the nozzle to the maximum dispersal point is represented by "C".

Liquid is supplied to this spray set-up under pressure.

Liquid and compressed air or gas are mixed internally to produce a completely atomized spray.

When ordering only a spray set-up, 5713 retainer ring must be ordered separately. This component is included in a complete air atomizing nozzle assembly.

**Please contact your sales engineer for more information.**

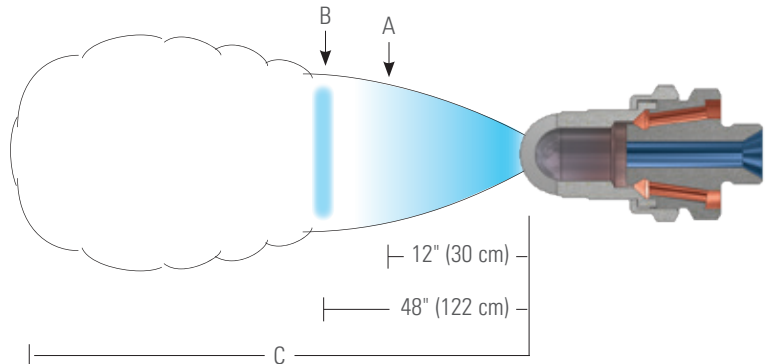

Spray Set-up No.	Spray Set-up Consists of Fluid and Air Cap Combination	Liquid Capacity (gallons per minute)* and Air Capacity (standard cubic feet per minute)*														Spray Dimensions			
		Liquid Pressure														A (in.)	B (in.)	C (ft.)	
		10 psi			20 psi			30 psi			40 psi			60 psi					
		Air Press.	gpm	scfm	Air Press.	gpm	scfm	Air Press.	gpm	scfm	Air Press.	gpm	scfm	Air Press.	gpm				scfm
SU155	Fluid Cap 4371000 + Air Cap 11093187	12.0	3.2	43	22	5.1	52	32	6.5	64	42	7.7	79	60	10.6	99	23 - 49	70 - 126	21 - 39
		14.0	2.4	51	24	4.1	62	34	5.5	75	44	6.7	90	62	9.5	108			
		16.0	1.7	61	26	3.3	72	36	4.5	86	46	5.7	100	64	8.4	118			
		-	-	-	28	2.6	85	38	3.6	96	48	4.9	110	66	7.5	130			
		-	-	-	30	2.0	94	40	3.1	106	50	4.2	120	68	6.8	142			
		-	-	-	32	1.6	104	42	2.6	116	52	3.6	132	70	6.1	152			
		-	-	-	-	-	-	44	2.2	128	54	3.1	140	72	5.5	166			
		-	-	-	-	-	-	46	1.8	136	56	2.7	150	74	5.0	178			
		-	-	-	-	-	-	-	-	-	58	2.3	164	76	4.5	190			

\*At the stated pressure in psi.





**PERFORMANCE DATA:  
PRESSURE SPRAY SET-UPS | EXTERNAL MIX | FLAT SPRAY**

For a flat spray pattern, "A" and "B" are the pattern widths at distances from the nozzle.

The total distance of spray projection from the nozzle to the maximum dispersal point is represented by "C".

Liquid is supplied to this spray set-up under pressure.

The liquid and compressed air or gas are mixed externally to produce a completely atomized spray.

For external mix spray set-ups, atomization can be controlled by varying the air pressure without changing liquid flow rate.

When ordering only a spray set-up, 12415 retainer ring must be ordered separately. This component is included in a complete air atomizing nozzle assembly.

**Please contact your sales engineer for more information.**

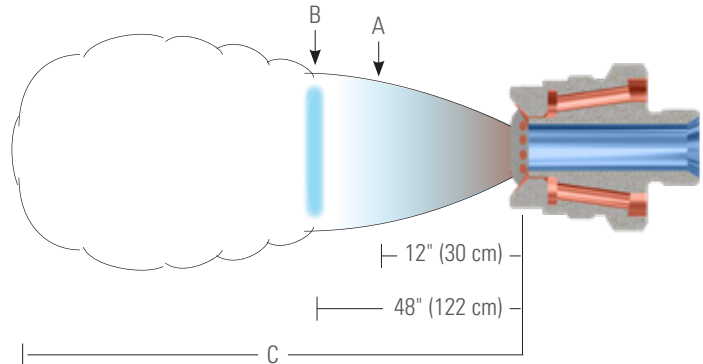

Spray Set-up No.	Spray Set-up Consists of Fluid and Air Cap Combination	Liquid Capacity (gallons per minute)* and Air Capacity (standard cubic feet per minute)*															Spray Dimensions		
		Liquid Pressure															A (in.)	B (in.)	C (ft.)
		3			5			7			10			15					
		Air Press.	gpm	scfm	Air Press.	gpm	scfm	Air Press.	gpm	scfm	Air Press.	gpm	scfm	Air Press.	gpm	scfm			
SUE175B	Fluid Cap 625780 + Air Cap 12116	20	13.0	87	25	17.0	101	30	20	115	40	23	140	50	29	166	20 - 23	47 - 51	25 - 35
		25	13.0	101	30	17.0	115	40	20	140	50	23	166	60	29	191			
		30	13.0	115	40	17.0	140	50	20	166	60	23	191	70	29	216			
		40	13.0	140	50	17.0	166	60	20	191	70	23	216	80	29	242			
		50	13.0	166	60	17.0	191	70	20	216	80	23	242	90	29	268			
		60	13.0	191	70	17.0	216	80	20	242	90	23	268	-	-	-			

\*At the stated pressure in psi.





PERFORMANCE DATA:  
SIPHON/GRAVITY SPRAY SET-UPS | EXTERNAL MIX | ROUND SPRAY

For a round spray pattern, "A" and "B" are the pattern widths at distances from the nozzle.

The total distance of spray projection from the nozzle to the maximum dispersal point is represented by "C".

Liquid is supplied to this spray set-up by either a liquid siphon or a gravity-feed. The liquid drawn through the feed line into the air flow where it is atomized.

When ordering only a spray set-up, 5713 retainer ring must be ordered separately. This component is included in a complete air atomizing nozzle assembly.

**Please contact your sales engineer for more information.**

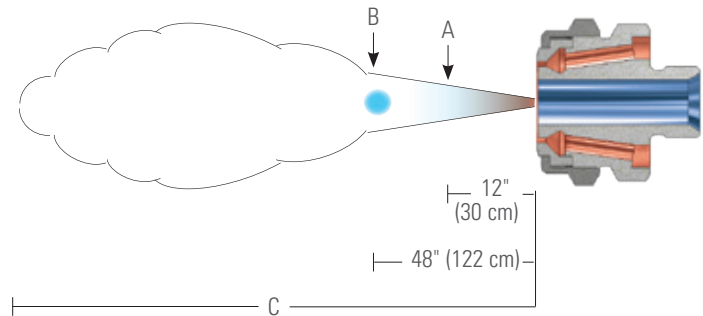

Spray Set-up No.	Spray Set-up Consists of Fluid and Air Cap Combination	Atomizing Air		Liquid Capacity (gallons per minute)*							Spray Dimensions at 8" Siphon Height		
		Air Press.	Air Capacity scfm	Gravity Head (in.)			Siphon Height (in.)				A (in.)	B (in.)	C (ft.)
				18	12	6	4	8	12	18			
SU170	Fluid Cap 6251000 + Air Cap 1125	20	105	-	-	3.4	1.9	-	-	-	5	15	29 - 64
		25	120	5.2	4.5	3.6	2.2	-	-	-			
		30	135	5.3	4.6	3.8	2.4	1.4	-	-			
		40	165	5.4	4.7	3.9	2.6	1.8	1.1	-			
		60	225	5.5	4.9	4.2	2.9	2.2	1.5	.40			
		80	285	5.6	5.0	4.4	3.0	2.3	1.6	.50			
		100	345	5.7	5.1	4.5	3.1	2.4	1.7	.60			

\*At the stated pressure in psi.





**PERFORMANCE DATA:  
PRESSURE SPRAY SET-UPS | INTERNAL | ROUND SPRAY**

For this QuickMist round spray set-up, angle "A" is maintained throughout distance "B". Beyond "B", the spray becomes turbulent and projects out to distance "C".

Liquid is supplied to this spray set-up under pressure.

Liquid and compressed air or gas are mixed internally to produce a completely atomized spray.

**Please contact your sales engineer for more information.**

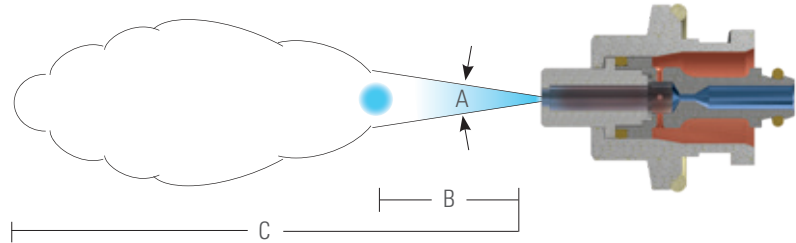

Spray Set-up No.	Spray Set-up Consists of Fluid and Air Cap Combination	Liquid Capacity (gallons per hour)* and Air Capacity (standard cubic feet per minute)*																		Spray Dimensions		
		Liquid Pressure																		Spray Angle A (°)	B (in.)	C (ft.)
		20 psi			30 psi			40 psi			50 psi			60 psi			70 psi					
		Air Press.	gph	scfm	Air Press.	gph	scfm	Air Press.	gph	scfm	Air Press.	gph	scfm	Air Press.	gph	scfm	Air Press.	gph	scfm			
SUQR220B	Fluid Cap PFO40 + Air Cap PAQR95	20	6.8	1.5	20	10.9	1.3	-	-	-	-	-	-	-	-	-	-	-	-	12 - 15	10 - 22	14 - 25
		30	3.9	2.2	30	8.0	2.0	30	11.5	1.8	30	14.4	1.5	-	-	-	-	-	-			
		-	-	-	40	5.4	2.7	40	9.0	2.4	40	11.9	2.2	40	14.9	2.0	-	-	-			
		-	-	-	50	3.0	3.3	50	6.6	3.1	50	9.6	2.8	50	12.6	2.6	50	15.4	2.5			
		-	-	-	-	-	-	60	4.3	3.7	60	7.3	3.5	60	10.4	3.2	60	13.3	3.0			
		-	-	-	-	-	-	-	-	-	70	5.1	4.2	70	8.3	3.9	70	11.2	3.7			

\*At the stated pressure in psi.





PERFORMANCE DATA:  
PRESSURE SPRAY SET-UPS | INTERNAL | WIDE ANGLE ROUND SPRAY

For these QuickMist wide angle round spray set-ups, "A" and "B" are the pattern widths at distances from the nozzle.

The total distance of spray projection from the nozzle to the maximum dispersal point is represented by "C".

Liquid is supplied to this spray set-up under pressure.

Liquid and compressed air or gas are mixed internally to produce a completely atomized spray.

**Please contact your sales engineer for more information.**

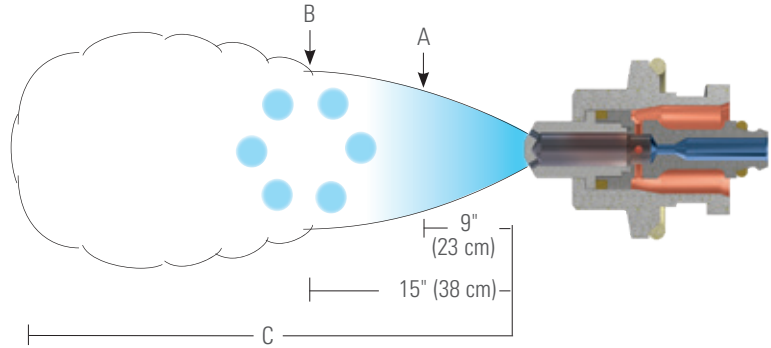

Spray Set-up No.	Spray Set-up Consists of Fluid and Air Cap Combination	Liquid Capacity (gallons per hour)* and Air Capacity (standard cubic feet per minute)*																		Spray Dimensions									
		Liquid Pressure																		A (in.)	B (in.)	C (ft.)							
		20 psi			30 psi			40 psi			50 psi			60 psi			70 psi												
Air Press.	gph	scfm	Air Press.	gph	scfm	Air Press.	gph	scfm	Air Press.	gph	scfm	Air Press.	gph	scfm	Air Press.	gph	scfm	Air Press.	gph	scfm									
SUQW260B	Fluid Cap PFO30 + Air Cap PAQW37-60	20	4.9	1.7	-	-	-	-	-	-	-	-	-	-	-	-	-	-	-	-	-	-	7 - 9	8 - 12	9 - 18				
		30	3.4	2.5	30	5.3	2.3	30	7.1	2.1	30	8.6	2.0	-	-	-	-	-	-	-	-	-				-	-	-	
		-	-	-	40	3.8	2.9	40	5.8	2.8	40	7.4	2.6	40	8.9	2.4	40	102	2.4	40	9.2	3.0				-	-	-	
		-	-	-	50	2.1	3.6	50	4.4	3.4	50	6.3	3.3	50	7.8	3.1	50	9.2	3.0	50	8.2	3.7				-	-	-	
		-	-	-	-	-	-	60	3.0	4.1	60	5.1	4.0	60	6.8	3.8	60	8.2	3.7	60	7.2	4.4				-	-	-	
SUQW260	Fluid Cap PFO60 + Air Cap PAQW37-60	20	7.4	1.9	20	19.3	0.90	-	-	-	-	-	-	-	-	-	-	-	-	-	-	-	7 - 9	9 - 13	12 - 19				
		-	-	-	30	8.9	2.4	30	19.3	1.3	30	27	0.90	-	-	-	-	-	-	-	-	-				-	-	-	
		-	-	-	-	-	-	40	9.6	3.0	40	20	1.8	40	28	1.3	-	-	-	-	-	-				-	-	-	
		-	-	-	-	-	-	-	-	-	50	10.4	3.6	50	20	2.3	50	28	1.6	50	21	2.8				-	-	-	
		-	-	-	-	-	-	-	-	-	-	-	-	60	11.1	4.1	60	21	2.8	70	12.0	4.8				-	-	-	
SUQW290	Fluid Cap PFO60 + Air Cap PAQW52-60	20	12.5	3.3	-	-	-	-	-	-	-	-	-	-	-	-	-	-	-	-	-	-	7 - 9	9 - 13	12 - 19				
		30	5.5	5.1	30	14.2	4.1	-	-	-	-	-	-	-	-	-	-	-	-	-	-	-				-	-	-	
		-	-	-	40	8.5	5.8	40	16.4	4.9	-	-	-	-	-	-	-	-	-	-	-	-				-	-	-	-
		-	-	-	50	3.3	7.4	50	10.7	6.5	50	19.0	5.4	50	26	5.2	50	31	4.9	50	26	6.0				-	-	-	
		-	-	-	-	-	-	60	5.2	8.2	60	13.1	7.1	60	21	6.5	60	26	6.0	70	21	7.3				-	-	-	

\*At the stated pressure in psi.





**PERFORMANCE DATA:  
PRESSURE SPRAY SET-UPS | INTERNAL | FLAT SPRAY**

For these QuickMist flat spray set-ups, "A" and "B" are the pattern widths at distances from the nozzle.

The total distance of spray projection from the nozzle to the maximum dispersal point is represented by "C".

Liquid is supplied to this spray set-up under pressure.

Liquid and compressed air or gas are mixed internally to produce a completely atomized spray.

**Please contact your sales engineer for more information.**

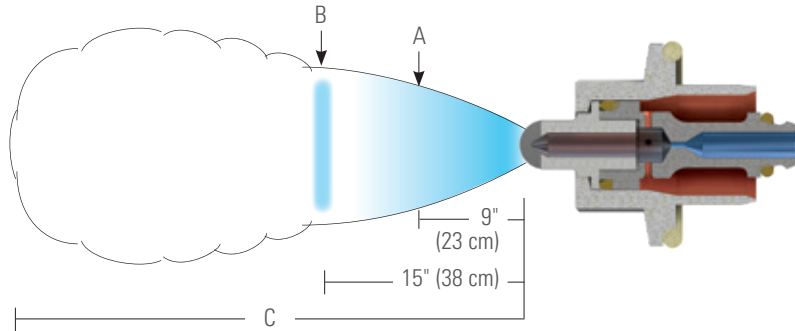

Spray Set-up No.	Spray Set-up Consists of Fluid and Air Cap Combination	Liquid Capacity (gallons per hour)* and Air Capacity (standard cubic feet per minute)*																		Spray Dimensions									
		Liquid Pressure																		A (in.)	B (in.)	C (ft.)							
		20 psi			30 psi			40 psi			50 psi			60 psi			70 psi												
Air Press.	gph	scfm	Air Press.	gph	scfm	Air Press.	gph	scfm	Air Press.	gph	scfm	Air Press.	gph	scfm	Air Press.	gph	scfm	Air Press.	gph	scfm									
SUQF130	Fluid Cap PFQ20 + Air Cap PAQF28	20	1.5	1.3	20	2.9	1.13	20	3.9	1.1	-	-	-	-	-	-	-	-	-	-	-	-	5 - 10	7 - 14	10 - 21				
		-	-	-	30	1.7	1.7	30	3.0	1.5	30	4.0	1.4	30	4.7	1.4	-	-	-	-	-	-				-	-	-	
		-	-	-	-	-	-	40	1.9	2.1	40	3.1	1.9	40	4.1	1.8	40	4.9	1.7	-	-	-				-	-	-	-
		-	-	-	-	-	-	-	-	-	50	2.0	2.4	50	3.2	2.3	50	4.1	2.2	-	-	-				-	-	-	-
		-	-	-	-	-	-	-	-	-	-	-	-	-	-	-	70	2.4	3.2	-	-	-				-	-	-	-
SUQFN130	Fluid Cap PFQ30 + Air Cap PAQF28	20	2.7	1.1	-	-	-	-	-	-	-	-	-	-	-	-	-	-	-	-	-	-	8 - 12	11 - 19	14 - 27				
		-	-	-	30	3.1	1.5	30	5.9	1.2	-	-	-	-	-	-	-	-	-	-	-	-				-	-	-	
		-	-	-	-	-	-	40	3.4	1.8	40	6.0	1.5	-	-	-	-	-	-	-	-	-				-	-	-	
		-	-	-	-	-	-	-	-	-	50	3.7	2.2	50	6.1	1.9	50	8.1	1.7	-	-	-				-	-	-	-
		-	-	-	-	-	-	-	-	-	-	-	-	60	4.0	2.5	60	6.2	2.2	-	-	-				-	-	-	-
SUQF230B	Fluid Cap PFQ30 + Air Cap PAQF35	20	3	1.2	-	-	-	-	-	-	-	-	-	-	-	-	-	-	-	-	-	-	7 - 11	9 - 16	12 - 22				
		-	-	-	30	3.5	1.6	30	6.1	1.3	-	-	-	-	-	-	-	-	-	-	-	-				-	-	-	
		-	-	-	-	-	-	40	3.8	2.0	40	6.2	1.7	40	8.2	1.6	-	-	-	-	-	-				-	-	-	
		-	-	-	-	-	-	-	-	-	50	4.2	2.3	50	6.4	2.1	50	8.2	1.9	-	-	-				-	-	-	
		-	-	-	-	-	-	-	-	-	60	2.0	3.2	60	4.5	2.7	60	6.6	2.4	-	-	-				-	-	-	-
SUQF230	Fluid Cap PFQ40 + Air Cap PAQF40	20	4.8	1.1	-	-	-	-	-	-	-	-	-	-	-	-	-	-	-	-	-	-	8 - 14	11 - 18	15 - 21				
		-	-	-	30	5.5	1.5	-	-	-	-	-	-	-	-	-	-	-	-	-	-	-				-	-	-	
		-	-	-	-	-	-	40	6.1	1.8	-	-	-	-	-	-	-	-	-	-	-	-				-	-	-	
		-	-	-	-	-	-	-	-	-	50	1.5	2.8	50	6.6	2.2	50	10.8	1.7	-	-	-				-	-	-	
		-	-	-	-	-	-	-	-	-	60	2.5	3.1	60	7.2	2.5	60	11.0	2.1	-	-	-				-	-	-	
-	-	-	-	-	-	-	-	-	-	-	-	-	-	-	70	7.8	2.8	-	-	-	-	-	-	-					

\*At the stated pressure in psi.







PERFORMANCE DATA:  
SIPHON/GRAVITY SPRAY SET-UPS | INTERNAL MIX | ROUND SPRAY

For a round spray pattern, angle "A" is maintained throughout distance "B". Beyond "B", the spray becomes turbulent and projects out to distance "C".

Liquid is supplied to this spray set-up by either a liquid siphon or a gravity-feed.

Liquid is drawn through the feed line into the air flow where it is atomized.

**Please contact your sales engineer for more information.**

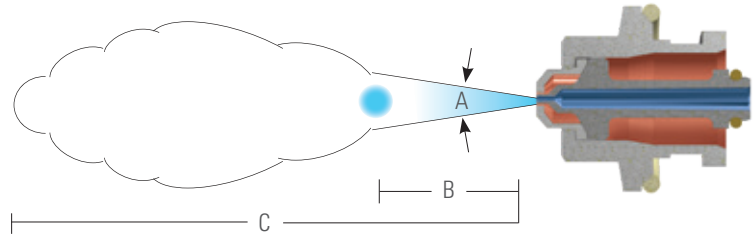

Spray Set-up No.	Spray Set-up Consists of Fluid and Air Cap Combination	Liquid Capacity (gallons per hour)* and Air Capacity (standard cubic feet per minute)*									Spray Dimensions at 8" Siphon Height		
		Atomizing Air		Liquid Capacity (gallons per hour)*							Spray Angle A (°)	B (in.)	C (ft.)
		Air Press.	Air Capacity scfm	Gravity Head (in.)			Siphon Height (in.)						
				18	12	6	4	8	12	24			
SUQR200	Fluid Cap PFO5028 + Air Cap PAQR070	10	.7	1.1	1.1	0.90	0.74	0.54	0.39	—	19 - 20	15 - 22	7 - 9.3
		20	1.0	1.2	1.1	0.90	0.81	0.66	0.59	—			
		40	1.6	1.4	1.3	1.2	1.2	1.1	1.0	0.55			
		60	2.2	1.2	1.2	1.3	1.0	1.1	0.84	0.65			
SUQR300	Fluid Cap PFO10060 + Air Cap PAQR120	10	1.1	5.2	4.6	3.8	2.4	1.1	—	—	19 - 20	16 - 21	12 - 16
		20	1.7	5.5	4.8	4.1	3.1	2.4	—	—			
		40	2.7	6.0	5.4	4.9	4.2	3.5	2.8	—			
		60	3.8	6.1	5.6	5.0	4.6	3.8	3.1	0.67			

\*At the stated pressure in psi.





**PERFORMANCE DATA:  
SIPHON/GRAVITY SPRAY SET-UPS | INTERNAL MIX | FLAT SPRAY**

For these QuickMist flat spray set-ups, "A" is the spray pattern width at 6" (15 cm). Beyond distance "B" the spray becomes turbulent and projects out to distance "C".

Liquid is supplied to this spray set-up by either a liquid siphon or a gravity-feed.

Liquid is drawn through the feed line into the air flow where it is atomized.

**Please contact your sales engineer for more information.**

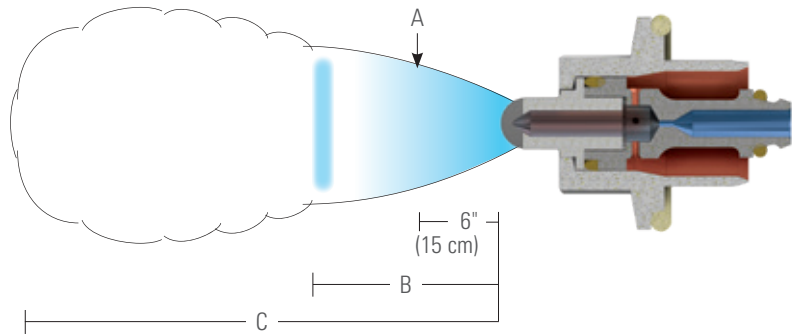

Spray Set-up No.	Spray Set-up Consists of Fluid and Air Cap Combination	Liquid Capacity (gallons per hour)* and Air Capacity (standard cubic feet per minute)*								Spray Dimensions at 8" Siphon Height			
		Atomizing Air		Liquid Capacity (gallons per hour)*									
		Air Press.	Air Capacity scfm	Gravity Head (in.)			Siphon Height (in.)			A (in.)	B (in.)	C (ft.)	
				18	12	6	4	8	12				24
SUQF200C	Fluid Cap PFQ10035 + Air Cap PAQF450121	10.0	1.3	2.1	1.8	1.6	1.2	1.1	1.1	0.34	8	7-10	2-3
		20	1.9	2.0	1.8	1.6	1.4	1.3	1.2	0.55			
		40	3.1	1.8	1.6	1.5	1.5	1.4	1.3	0.75			
		60	4.3	1.5	1.4	1.2	1.4	1.3	1.2	0.77			
SUQF300B	Fluid Cap PFQ10040 + Air Cap PAQF450121	10.0	1.3	2.2	1.9	1.7	1.4	1.3	0.91	0.48	6	6-7	3-4
		20	1.9	2.1	1.9	1.8	1.4	1.3	1.1	0.63			
		40	3.1	1.9	1.8	1.7	1.5	1.4	1.3	0.83			
		60	4.3	1.6	1.6	1.5	1.4	1.3	1.2	1.0			
SUQF300	Fluid Cap PFQ10060 + Air Cap PAQF450121	10.0	1.3	2.8	2.4	2.0	1.7	1.5	1.3	0.63	4	4-5	4-4
		20	1.9	2.6	2.2	2.0	1.8	1.6	1.4	0.85			
		40	3.1	2.0	1.8	1.6	1.9	1.7	1.5	1.1			
		60	4.3	1.4	1.3	1.1	1.7	1.5	1.3	1.1			

\*At the stated pressure in psi.



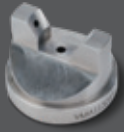

PERFORMANCE DATA:  
PRESSURE SPRAY SET-UPS | EXTERNAL MIX | VARIABLE SPRAY

SUVM spray set-ups provide uniform spray distribution even when spraying viscous liquids.

Liquid is supplied to this spray set-up under pressure.

The liquid and compressed air or gas are mixed externally to produce a completely atomized spray.

For external mix spray set-ups, atomization can be controlled by varying the air pressure without changing liquid flow rate.

Independent control of fan air provides the ability to adjust the spray pattern without changing liquid flow rate.

Spray coverage dimensions are provided in the table below at various distances from the nozzle.

**Please contact your sales engineer for more information.**

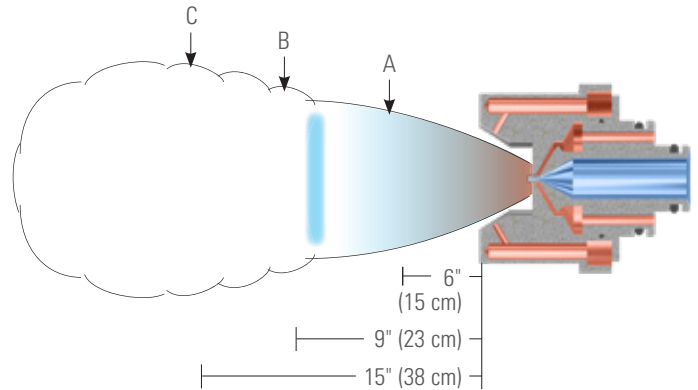

Spray Set-up No.	Spray Set-up Consists of Fluid and Air Cap Combination	Air Capacity*			Liquid Capacity*		Spray Coverage (in.) at Indicated Distance from Nozzle																						
		Press.	Capacity		Press.	Cap. gph	Atom. Air Press.	Water Press.	Fan Air Pressure																				
			Atomizing Air scfm	Fan Air scfm					0			5			10			20			30			40					
SUVM67B	Fluid Cap VMF1650 + Air Cap VMA67255-60	10.0	.58	2.0	1.0	.44	10.0	3.0	2.0	3.0	4.0	5.0	6.0	7.0	7.0	9.0	10.0	7.0	9.0	11.0	3.5	4.0	6.0	-	-	-			
									10.0	2.5	3.5	4.5	6.0	8.0	7.0	7.0	9.0	11.0	8.0	10.0	12.0	3.5	4.0	5.5	-	-	-		
									20	-	-	-	6.0	9.0	8.0	8.0	12.0	13.0	10.0	12.0	14.0	3.5	5.5	7.0	-	-	-		
		20	.84	3.1	3.0	.74	20	3.0	2.0	3.0	4.5	4.0	5.0	6.0	6.0	7.0	8.0	7.0	9.0	10.0	8.0	10.0	12.0	4.5	5.0	6.0	7.0	8.0	10.0
								10.0	2.0	3.0	4.0	5.0	7.0	7.0	7.0	9.0	10.0	8.0	10.0	12.0	4.5	5.0	6.0	7.0	8.0	10.0			
								20	2.0	3.0	4.0	6.0	7.0	8.0	8.0	10.0	12.0	9.0	12.0	14.0	6.0	7.5	9.0	7.0	8.0	10.0			
		30	1.1	3.9	5.0	1.0	30	3.0	2.0	3.0	4.5	3.0	4.0	5.0	5.0	6.0	7.0	6.0	8.0	10.0	5.5	6.0	7.0	7.0	9.0	11.0			
								10.0	2.0	3.0	4.5	4.0	4.5	6.0	6.0	7.5	10.0	7.0	9.0	11.0	5.5	6.5	8.0	7.0	9.0	12.0			
								20	2.0	3.0	4.0	4.5	6.0	7.0	7.0	9.0	12.0	8.0	10.0	12.0	6.0	7.0	9.0	8.0	9.0	11.0			
		40	1.8	6.6	10.0	1.4	40	3.0	2.5	3.5	6.0	3.5	4.5	5.0	5.0	6.0	8.0	6.0	8.0	10.0	5.0	6.5	8.0	7.0	9.0	11.0			
								10.0	2.0	3.0	5.0	4.0	5.0	5.0	5.0	7.0	9.0	7.0	9.0	11.0	6.0	7.5	9.0	7.0	9.0	11.0			
								20	2.0	3.0	4.5	4.0	5.5	6.0	6.0	8.0	10.0	8.0	9.0	11.0	6.0	7.5	10.0	8.0	10.0	12.0			
		60	2.0	7.5	15.0	1.7	60	3.0	2.5	3.5	6.0	3.0	4.5	4.0	4.0	5.0	6.0	5.0	7.0	9.0	5.0	6.5	10.0	7.0	9.0	11.0			
								10.0	2.5	3.0	5.0	3.5	4.0	4.5	4.5	5.0	7.0	7.0	9.0	11.0	6.0	7.5	11.0	8.0	10.0	12.0			
								20	2.0	3.0	4.5	3.5	5.0	5.0	5.0	7.0	9.0	7.0	9.0	11.0	6.0	7.5	11.5	8.0	10.0	12.0			
		70	2.3	8.3	20	1.9	70	3.0	2.5	3.5	6.0	3.0	4.5	4.0	4.0	5.0	6.0	5.0	7.0	9.0	5.0	6.5	10.0	7.0	9.0	11.0			
								10.0	2.5	3.0	5.0	3.5	4.0	4.5	4.5	5.0	7.0	7.0	9.0	11.0	6.0	7.5	11.0	8.0	10.0	12.0			
								20	2.0	3.0	4.5	3.5	5.0	5.0	5.0	7.0	9.0	7.0	9.0	11.0	6.0	7.5	11.5	8.0	10.0	12.0			
80	2.5	9.0	20	1.9	80	3.0	2.5	3.5	6.0	3.0	4.5	4.0	4.0	5.0	6.0	5.0	7.0	9.0	5.0	6.5	10.0	7.0	9.0	11.0					
						10.0	2.5	3.0	5.0	3.5	4.0	4.5	4.5	5.0	7.0	7.0	9.0	11.0	6.0	7.5	11.0	8.0	10.0	12.0					
						20	2.0	3.0	4.5	3.5	5.0	5.0	5.0	7.0	9.0	7.0	9.0	11.0	6.0	7.5	11.5	8.0	10.0	12.0					

\*At the stated pressure in psi.

Anti-bearding set-ups are available to reduce nozzle build-up and maintenance time for select external mix air atomizing nozzles. For more information, call 1.800.95.SPRAY.













**PERFORMANCE DATA:  
PRESSURE SPRAY SET-UPS | EXTERNAL MIX | FLAT SPRAY**

SUVXE spray set-ups provide uniform spray distribution even when spraying viscous liquids.

Liquid is supplied to this spray set-up under pressure.

The liquid and compressed air or gas are mixed externally to produce a completely atomized spray.

For external mix spray set-ups, atomization can be controlled by varying the air pressure without changing liquid flow rate.

Independent control of fan air provides the ability to adjust the spray pattern without changing liquid flow rate.

Spray coverage dimensions are provided in the table below at various distances from the nozzle.

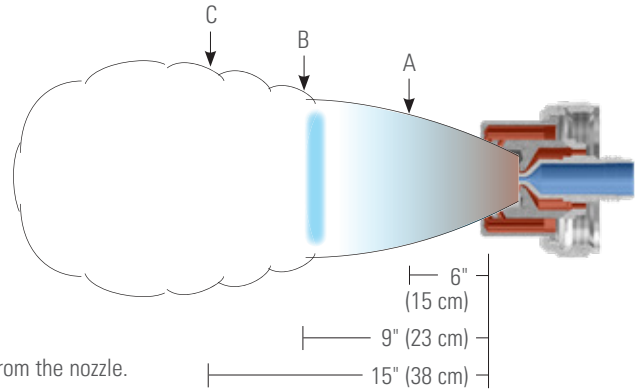

Spray Setup No.	Spray Set-up Consists of Fluid and Air Cap Combination	Liquid			Total Air Flow (scfm) and Spray Width (in.) at 6 in. from Nozzle**															
		Press.*	Flow Rate		Atom. Air Press.*	Fan Air Pressure*														
			gpm	gph		5		10		15		20		25		30		40		
		Flow	Width	Flow	Width	Flow	Width	Flow	Width	Flow	Width	Flow	Width	Flow	Width	Flow	Width			
SUVXE1A	PFX16 + PAVX140A	3	0.013	0.78	5	4.4	17.2													
					10	4.6	17.5													
					15	4.8	16.7													
					20	5.0	15.3	6.6	17.1											
		5	0.016	0.96	10	4.6	16.2	6.2	17.7											
					15	4.8	13.9	6.4	17.6											
					20	5.0	13.2	6.6	17.0											
		10	0.023	1.38	15	4.8	13.3	6.4	15.4	7.6	17.2									
					20	5.0	12.8	6.6	15.2	7.8	16.9									
					25	5.1	11.4	6.7	13.8	7.9	16.3	8.9	17.9							
					30	5.3	10.0	6.9	13.3	8.1	15.2	9.1	17.2							
		15	0.029	1.74	20	5.0	13.9	6.6	17.0	7.8	17.3									
					25	5.1	12.5	6.7	15.4	7.9	16.8	8.9	17.8							
					30	5.3	11.1	6.9	13.8	8.1	15.5	9.1	17.6							
					40	5.7	9.6	7.3	11.6	8.5	14.7	9.5	15.6	10.4	17.5					
20	0.033	1.98	25	5.1	12.0	6.7	13.8	7.9	15.8	8.9	17.0									
			30	5.3	11.7	6.9	13.6	8.1	15.5	9.1	17.4									
			40	5.7	9.4	7.3	12.6	8.5	14.8	9.5	17.2	10.4	19.2							
SUVXE2C	PFX16 + PAVX156A	3	0.013	0.78	5	5.1	15.7													
					10	5.6	13.1	7.2	13.9											
					15	6.0	9.3	7.6	12.7	8.8	14.8									
					20	6.4	8.8	8.0	10.3	9.2	13.2									
		5	0.016	0.96	10	5.6	13.2	7.2	16.3											
					15	6.0	11.0	7.6	13.6	8.8	16.5									
					20	6.4	8.0	8.0	11.9	9.2	13.5	10.2	16.4							
					25	6.7	7.5	8.3	10.4	9.5	12.4	10.5	15.6							
		10	0.023	1.38	15	6.0	10.8	7.6	13.4	8.8	15.5	9.8	16.9							
					20	6.4	8.7	8.0	11.5	9.2	13.5	10.2	15.9	11.1	18.3					
					25	6.7	7.3	8.3	11.0	9.5	12.8	10.5	15.4	11.4	17.2					
					30	7.2	5.6	8.8	8.1	10.0	10.8	11.0	14.2	11.9	14.6	13.3	16.2			

\*At the stated pressure in psi  
 \*\*Data collected with water at 70°F. Blank cells are not recommended.



**PERFORMANCE DATA:  
PRESSURE SPRAY SET-UPS | EXTERNAL MIX | FLAT SPRAY**

Spray Setup No.	Spray Set-up Consists of Fluid and Air Cap Combination	Liquid			Total Air Flow (scfm) and Spray Width (in.) at 6 in. from Nozzle**														
		Press.*	Flow Rate		Atom. Air Press.*	Fan Air Pressure*													
			gpm	gph		5		10		15		20		25		30		40	
						Flow	Width	Flow	Width	Flow	Width	Flow	Width	Flow	Width	Flow	Width	Flow	Width
SUVXE2C	PFX16 + PAVX156A	15	0.029	1.74	20	6.4	9.1	8.0	11.5	9.2	13.6	10.2	15.0	11.1	15.8				
					25	6.7	6.8	8.3	9.1	9.5	13.1	10.5	15.0	11.4	15.8	12.8	16.6		
					30	7.2	6.1	8.8	8.9	10.0	10.9	11.0	13.7	11.9	15.4	13.3	16.2		
					40	7.9	5.2	9.5	6.8	10.7	10.3	11.7	12.6	12.6	14.8	14.0	15.9	16.3	16.8
		20	0.033	1.98	25	6.7	8.5	8.3	11.1	9.5	12.1	10.5	14.6	11.4	16.5	12.8	18.5		
					30	7.2	5.7	8.8	8.5	10.0	11.6	11.0	14.3	11.9	16.4	13.3	17.9		
					40	7.9	5.6	9.5	7.7	10.7	10.3	11.7	13.4	12.6	15.0	14.0	15.4	16.3	16.9
					SUVXE1	PFX20 + PAVX140A	3	0.020	1.2	5	4.4	16.7							
10	4.6	16.1																	
15	4.8	15.9																	
20	5.0	15.2	6.6	17.8															
5	0.026	1.56	10	4.6			15.9	6.2	18.6										
			15	4.8			14.5	6.4	17.5										
			20	5.0			14.2	6.6	17.0										
			25	5.1			13.1	6.7	16.5										
10	0.036	2.16	15	4.8			15.6	6.4	17.9										
			20	5.0			15.0	6.6	17.0										
			25	5.1			13.7	6.7	16.1	7.9	18.2								
			30	5.3			11.6	6.9	13.9	8.1	16.4	9.1	18.7						
15	0.045	2.7	20	5.0			15.0	6.6	17.0	7.8	18.1								
			25	5.1			13.9	6.7	15.7	7.9	17.0								
			30	5.3			11.7	6.9	15.0	8.1	16.6	9.1	18.6						
			40	5.7			9.1	7.3	12.9	8.5	15.7	9.5	16.0	10.4	16.9				
20	0.051	3.06	25	5.1	13.2	6.7	14.7	7.9	17.6	8.9	18.6								
			30	5.3	12.6	6.9	14.6	8.1	15.6	9.1	17.1	10.0	18.0						
			40	5.7	9.5	7.3	12.6	8.5	15.1	9.5	16.9	10.4	17.8	11.8	18.1				
			SUVXE2B	PFX20 + PAVX156A	3	0.020	1.2	5	5.1	15.6									
10	5.6	15.6																	
15	6.0	12.3																	
20	6.4	9.1						8.0	12.0										
5	0.026	1.56			10	5.6	14.1	7.2	16.9										
					15	6.0	12.0	7.6	15.7										
					20	6.4	9.2	8.0	13.5	9.2	14.3								
					25	6.7	7.5	8.3	11.1	9.5	13.2								
10	0.036	2.16			15	6.0	12.8	7.6	14.7	8.8	16.6								
					20	6.4	10.4	8.0	11.4	9.2	15.7								
					25	6.7	8.7	8.3	10.7	9.5	12.5	10.5	15.4	11.4	17.4				
					30	7.2	7.1	8.8	9.1	10.0	12.6	11.0	13.9	11.9	16.0				
15	0.045	2.7			20	6.4	8.7	8.0	12.2	9.2	16.6	10.2	18.4						
					25	6.7	9.8	8.3	11.9	9.5	14.2	10.5	16.2	11.4	17.3				
					30	7.2	6.9	8.8	8.9	10.0	12.0	11.0	15.1	11.9	15.9	13.3	18.1		
					40	7.9	6.0	9.5	8.1	10.7	10.6	11.7	13.0	12.6	15.4	14.0	16.6		
20	0.051	3.06	25	6.7	8.4	8.3	10.3	9.5	12.7	10.5	15.0	11.4	17.0						
			30	7.2	6.5	8.8	9.4	10.0	12.0	11.0	14.6	11.9	15.2	13.3	17.0				
			40	7.9	5.3	9.5	5.7	10.7	11.5	11.7	13.9	12.6	14.2	14.0	16.6	16.3	17.1		

\*At the stated pressure in psi

\*\*Data collected with water at 70°F. Blank cells are not recommended.







**PERFORMANCE DATA:  
PRESSURE SPRAY SET-UPS | EXTERNAL MIX | FLAT SPRAY**

Spray Setup No.	Spray Set-up Consists of Fluid and Air Cap Combination	Liquid			Total Air Flow (scfm) and Spray Width (in.) at 6 in. from Nozzle**																		
		Press.*	Flow Rate		Atom. Air Press.*	Fan Air Pressure*																	
			gpm	gph		5		10		15		20		25		30		40					
						Flow	Width	Flow	Width	Flow	Width	Flow	Width	Flow	Width	Flow	Width	Flow	Width				
SUVXE4B	PFX60 + PAVX200A	3	0.18	10.8	5	7.4	15.4	9.0	21.7														
					10	8.9	10.8	10.5	19.3														
					15	10.1	10.9	11.7	15.7														
					20	11.1	7.8	12.6	10.7	13.8	13.4												
		5	0.23	13.8	10	8.9	11.0	10.5	14.6	11.7	21.2												
					15	10.1	9.3	11.7	12.9	12.9	14.0												
					20	11.1	7.5	12.6	10.2	13.8	12.0	14.9	15.0										
					25	11.9	7.2	13.5	9.1	14.7	11.9	15.7	12.9										
		10	0.32	19.2	15	10.1	9.1	11.7	11.9	12.9	15.0												
					20	11.1	7.1	12.6	10.5	13.8	12.3	14.9	16.1										
					25	11.9	7.4	13.5	9.1	14.7	12.2	15.7	14.3										
					30	13.3	6.2	14.8	8.3	16.0	10.7	17.1	11.8	18.0	14.7								
		15	0.40	24	20	11.1	7.7	12.6	10.7	13.8	13.4	14.9	16.5										
					25	11.9	6.5	13.5	9.0	14.7	12.6	15.7	13.9	16.6	16.7								
					30	13.3	6.2	14.8	8.3	16.0	10.9	17.1	13.3	18.0	13.8								
					40	15.4	4.7	17.0	6.4	18.2	8.4	19.2	10.8	20.1	11.3	21.5	14.2						
20	0.46	27.6	25	11.9	7.0	13.5	10.0	14.7	12.2	15.7	14.9	16.6	17.0										
			30	13.3	7.0	14.8	9.5	16.0	11.1	17.1	13.5	18.0	15.6	19.4	16.9								
			40	15.4	4.9	17.0	7.3	18.2	9.7	19.2	11.8	20.1	14.0	21.5	14.4	23.7	16.2						
SUVXE4A	PFX80 + PAVX200A	3	0.31	18.6	5	7.4	11.2	9.0	12.6	10.2	16.3												
					10	8.9	11.5	10.5	12.6	11.7	15.7												
					15	10.1	10.0	11.7	12.7	12.9	15.1												
					20	11.1	9.3	12.6	11.4	13.8	14.6												
		5	0.40	24	10	8.9	10.6	10.5	12.1	11.7	14.7												
					15	10.1	10.0	11.7	11.9	12.9	13.6												
					20	11.1	8.7	12.6	10.4	13.8	13.0												
					25	11.9	9.0	13.5	10.9	14.7	12.2												
		10	0.56	33.6	15	10.1	9.1	11.7	11.1	12.9	12.0	13.9	13.4										
					20	11.1	9.4	12.6	10.3	13.8	11.3	14.9	12.5										
					25	11.9	8.0	13.5	10.5	14.7	11.6	15.7	11.7										
					30	13.3	7.6	14.8	10.0	16.0	11.4	17.1	12.3										
		15	0.69	41.4	20	11.1	9.8	12.6	10.9	13.8	11.7	14.9	12.8										
					25	11.9	9.1	13.5	11.0	14.7	11.4	15.7	12.3										
					30	13.3	8.6	14.8	10.2	16.0	11.4	17.1	12.0										
					40	15.4	7.1	17.0	9.4	18.2	9.9	19.2	11.3										
20	0.79	47.4	25	11.9	9.1	13.5	10.2	14.7	11.1	15.7	11.1	16.6	12.6										
			30	13.3	8.1	14.8	9.8	16.0	10.7	17.1	11.7	18.0	12.2										
			40	15.4	7.4	17.0	9.3	18.2	10.2	19.2	10.9	20.1	11.8										

\*At the stated pressure in psi  
\*\*Data collected with water at 70°F. Blank cells are not recommended.



**PERFORMANCE DATA:  
PRESSURE SPRAY SET-UPS | EXTERNAL MIX | FLAT SPRAY**

Spray Setup No.	Spray Set-up Consists of Fluid and Air Cap Combination	Liquid			Total Air Flow (scfm) and Spray Width (in.) at 6 in. from Nozzle**																	
		Press.*	Flow Rate		Atom. Air Press.*	Fan Air Pressure*																
			gpm	gph		5		10		15		20		25		30		40				
						Flow	Width	Flow	Width	Flow	Width	Flow	Width	Flow	Width	Flow	Width	Flow	Width			
SUVXE4	PFX100 + PAVX200A	3	0.49	29.4	5	7.4	10.4															
					10	8.9	7.5	10.5	10.0													
					15	10.1	4.8	11.7	8.1	12.9	11.1											
					20	11.1	4.5	12.6	5.9	13.8	9.1											
		5	0.64	38.4	10	8.9	8.3	10.5	11.7													
					15	10.1	5.8	11.7	8.1	12.9	9.9											
					20	11.1	4.4	12.6	5.0	13.8	7.3											
					25	11.9	3.0	13.5	4.1	14.7	6.3	15.7	8.2									
		10	0.90	54	15	10.1	5.4	11.7	7.8	12.9	8.9											
					20	11.1	3.5	12.6	5.7	13.8	7.5	14.9	10.6									
					25	11.9	2.8	13.5	5.3	14.7	6.9	15.7	10.2									
					30	13.3	2.9	14.8	4.2	16.0	6.0	17.1	8.9	18.0	10.6							
		15	1.1	66	20	11.1	4.5	12.6	5.4	13.8	7.4	14.9	11.7									
					25	11.9	3.2	13.5	4.1	14.7	7.1	15.7	10.1									
					30	13.3	3.2	14.8	3.9	16.0	6.2	17.1	9.6	18.0	11.0							
					40	15.4	2.6	17.0	3.6	18.2	4.6	19.2	6.4	20.1	8.6							
		20	1.3	78	25	11.9	3.7	13.5	5.6	14.7	7.8	15.7	10.9									
					30	13.3	3.0	14.8	5.3	16.0	6.8	17.1	9.7	18.0	10.3							
					40	15.4	2.4	17.0	2.9	18.2	3.9	19.2	6.1	20.1	7.2	21.5	9.8	23.7	12.0			

\*At the stated pressure in psi

\*\*Data collected with water at 70°F. Blank cells are not recommended.



**NUMBERING SYSTEM FOR AIR CAPS AND FLUID CAPS**

The drawings below illustrate the measurements used in the Spray Performance Data charts.

**AIR CAPS  
PRESSURE SET-UPS (INTERNAL MIX)**

**Round Spray Pattern**

Example: Air Cap No. PA67147

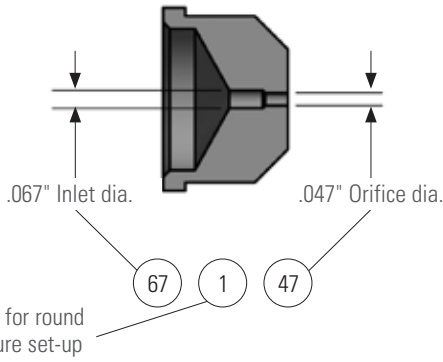

**Wide Angle Round Spray Pattern**

Example: Air Cap No. PA67-6-20-70

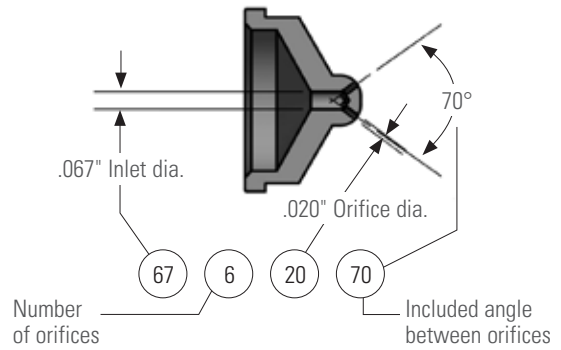

**Flat Spray Pattern**

Example: Air Cap No. PA73320

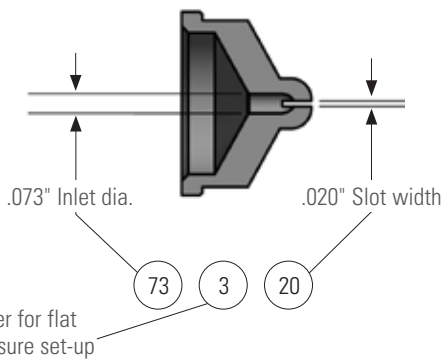

Dimensions shown are nominal and subject to manufacturing tolerances.

**PLACING YOUR ORDER**

**Call 1.800.95.SPRAY for application assistance  
or to place an order.**

**AIR CAPS**

**SIPHON/GRAVITY FEED SET-UPS (EXTERNAL MIX)**

**Round Spray Pattern**

Example: Air Cap No. PA64

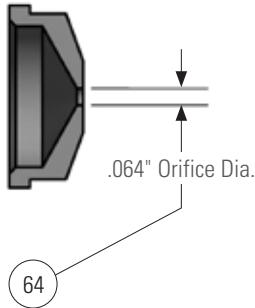

**Flat Round Spray Pattern**

Example: Air Cap No. PA73420

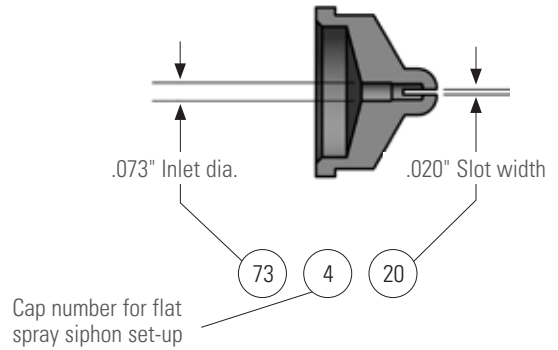

**AIR CAPS**

**PRESSURE SET-UPS (EXTERNAL MIX)**

**Flat Spray Pattern**

Example: Air Cap No. PA200278-45

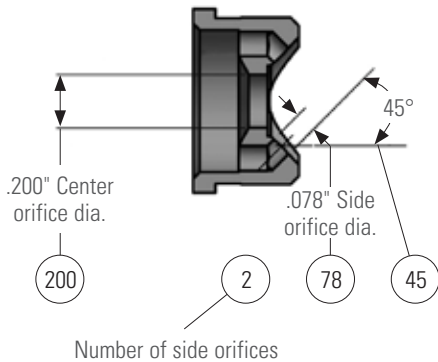

**FLUID CAP**

**FOR USE WITH ALL SET-UPS**

**Fluid Cap**

Example: Fluid Cap No. PF2850

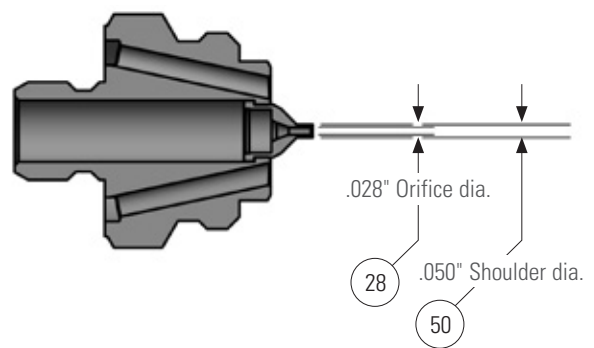

Dimensions shown are nominal and subject to manufacturing tolerances.

**AIR ATOMIZING SET-UP COMPATIBILITY**

Use the chart that follows to determine which spray set-ups can be used with our atomizing nozzles. The chart also includes the part number for the air cap and fluid cap that are required for each spray set-up.

Set-up No.	Spray Pattern	Fluid Cap No.	Air Cap No.
SU11	Round	PF2050	PA67147
SU12A	Round	PF2050	PA73160
SU12	Round	PF2850	PA73160
SU22B	Round	PF40100	PA1401110
SU22	Round	PF60100	PA1401110
SU42	Round	PF100150	PA1891125
SU16	Wide Angle Round	PF2050	PA67-6-20-70
SU26B	Wide Angle Round	PF40100	PA140-6-37-70
SU26	Wide Angle Round	PF60100	PA140-6-37-70
SU29	Wide Angle Round	PF60100	PA140-6-52-70
SU30	Wide Angle Round	PF40100	PA120-6-35-60
SU46	Wide Angle Round	PF100150	PA189-6-62-70
SU340C	360° Circular	PF60150	PA189-6-62-160HC
SU13A	Flat	PF2050	PA73328
SU13	Flat	PF2850	PA73328
SUN13	Flat	PF2850	PA73335
SU14	Flat	PF2850	PA73320
SUN23	Flat	PF60100	PA125340
SU23B	Flat	PF40100	PA125328
SU23	Flat	PF60100	PA125328
SU43	Flat	PF100150	PA189351
SU240E	Deflected Flat	PF28150	PA189110-75
SUE15B	Flat	PF1650	PA67228-45

Set-up No.	Spray Pattern	Fluid Cap No.	Air Cap No.
SUE18B	Flat	PF1650	PA62240-60
SUE15A	Flat	PF2050	PA67228-45
SUE18A	Flat	PF2050	PA62240-60
SUE15	Flat	PF2850	PA67228-45
SUE18	Flat	PF2850	PA62240-60
SUE25B	Flat	PF35100	PA134255-45
SUE28B	Flat	PF35100	PA122281-60
SUE25A	Flat	PF40100	PA134255-45
SUE28A	Flat	PF40100	PA122281-60
SUE28	Flat	PF60100	PA122281-60
SUE25	Flat	PF60100	PA134255-45
SUE45B	Flat	PF60150	PA200278-45
SUE45A	Flat	PF80150	PA200278-45
SUE45	Flat	PF100150	PA200278-45
SUF1	Flat	PF2850	PA73420
SUF2C	Flat	PF35100	PA120432
SUF3B	Flat	PF40100	PA122435
SUF4B	Flat	PF40100	PA122440
SU1A	Round	PF1650	PA64
SU1	Round	PF2050	PA64
SU2A	Round	PF2050	PA70
SU2	Round	PF2850	PA70
SU4	Round	PF60100	PA120





Set-up No.	Spray Pattern	Fluid Cap No.	Air Cap No.
SU5	Round	PF100150	PA180
D-SU1A-W D-SU1A-W-CO	Wide Angle Round	Fluid caps and air caps not sold separately.	
D-SU1-W D-SU1-W-CO	Wide Angle Round		
D-SU2A-W D-SU2A-W-CO	Wide Angle Round		
D-SU2-W D-SU2-W-CO	Wide Angle Round		
D-SU4-W D-SU4-W-CO	Wide Angle Round		
D-SU5-W D-SU5-W-CO	Wide Angle Round		
SUJ11	Round		
SUJ12A	Round	PFJ2050	PAJ73160
SUJ12	Round	PFJ2850	PAJ73160
SUJ22B	Round	PFJ40100	PAJ1401110
SUJ22	Round	PFJ60100	PAJ1401110
SUJ340C	360° Circular	PFJ60100	PAJ150-6-62-160HC
SUJ16	Wide Angle Round	PFJ2050	PAJ67-6-20-70
SUJ26B	Wide Angle Round	PFJ40100	PAJ140-6-37-70
SUJ26	Wide Angle Round	PFJ60100	PAJ140-6-37-70
SUJ29	Wide Angle Round	PFJ60100	PAJ140-6-52-70
SUJ30	Wide Angle Round	PFJ40100	PAJ120-6-35-60
SUJ13A	Flat	PFJ2050	PAJ73328
SUJ13	Flat	PFJ2850	PAJ73328
SUJ14	Flat	PFJ2850	PAJ73320
SUJ23B	Flat	PFJ40100	PAJ125328
SUJ23	Flat	PFJ60100	PAJ125328
SUJE416-50	Flat	PFJ1650	PAJ105-50
SUJE417-50	Flat	PFJ2050	PAJ105-50

Set-up No.	Spray Pattern	Fluid Cap No.	Air Cap No.
SUJE418-50	Flat	PFJ2850	PAJ105-50
SUJE420-50	Flat	PFJ40100	PAJ135-50
SUJE416-65	Flat	PFJ1650	PAJ080-65
SUJE417-65	Flat	PFJ2050	PAJ080-65
SUJE418-65	Flat	PFJ2850	PAJ080-65
SUJE420-65	Flat	PFJ40100	PAJ125-65
SUJE421-65	Flat	PFJ60100	PAJ-125-65
SUJE416-90	Flat	PFJ1650	PAJ075-90
SUJE417-90	Flat	PFJ2050	PAJ075-90
SUJE418-90	Flat	PFJ2850	PAJ075-90
SUJE420-90	Flat	PFJ40100	PAJ115-90
SUJE421-90	Flat	PFJ60100	PAJ115-90
SUJ1A	Round	PFJ1650	PAJ64
SUJ1	Round	PFJ2050	PAJ64
SUJ2A	Round	PFJ2050	PAJ70
SUJ2	Round	PFJ2850	PAJ70
SUJ3	Round	PFJ2850	PAJ64-5
SUJ4B	Round	PFJ40100	PAJ120
SUJ4	Round	PFJ60100	PAJ120
SUJF1	Flat	PFJ2850	PAJ73420
SUJF2C	Flat	PFJ35100	PAJ120432
SUJF3B	Flat	PFJ40100	PAJ122435
SUJF4B	Flat	PFJ40100	PAJ122440
SU70	Round	PF250375	PA437
SU75	Flat	PF250375	PA4533102



Set-up No.	Spray Pattern	Fluid Cap No.	Air Cap No.
SU380C	360° Circular	PF251376	PA469-6-130-160HC
SU85	Flat	PF251376	PA4693102
SU77	Wide Angle Round	PF250375	PA422-6-73-70
SU78	Wide Angle Round	PF250375	PA422-6-94-70
SU79	Wide Angle Round	PF250375	PA469-6-125-70
SU89	Wide Angle Round	PF251376	PA469-6-130-70
SU72	Round	PF250375	PA4221250
SU82	Round	PF251376	PA4691312
SUE75	Flat	PF250375	PA14356
SU159	Wide Angle Round	PF4371000	PA1109-6-224-70
SU152	Round	PF4371000	PA11091547
SU172	Round	PF6251000	PA11251625
SU155	Flat	PF4371000	PA11093187
SUE175B	Flat	PF625780	PA12116
SU170	Round	PF6251000	PA1125
SUQR-220B	Round	PFQ40	PAQR95
SUQW-260B	Wide Angle Round	PFQ30	PAQW37-60
SUQW-260	Wide Angle Round	PFQ60	PAQW37-60
SUQW-290	Wide Angle Round	PFQ60	PAQW52-60
SUQF-130	Flat	PFQ20	PAQF28
SUQF-N130	Flat	PFQ30	PAQF28
SUQF-230B	Flat	PFQ30	PAQF35
SUQF-230	Flat	PFQ40	PAQF40
SUQR-200	Round	PFQ5028	PAQR070
SUQR-300	Round	PFQ10060	PAQR120
SUQF-200C	Flat	PFQ10035	PAQF450121
SUQF-300B	Flat	PFQ10040	PAQF450121

Set-up No.	Spray Pattern	Fluid Cap No.	Air Cap No.
SUQF-300	Flat	PFQ10060	PAQF450121
SUVM67B	Variable	VMF1650	VMA67255-60
SUVM67A	Variable	VMF2050	VMA67255-60
SUVM67	Variable	VMF2850	VMA67255-60
SUVM113A	Variable	VMF3578	VMA113289-60
SUVM113	Variable	VMF4078	VMA113289-60
SUVM128	Variable	VMF60100	VMA1282100-60
SUVM152	Variable	VMF80125	VMA1522110-60
SUV67B	Variable	VF1650	VA67255-60
SUV67A	Variable	VF2050	VA67255-60
SUV67	Variable	VF2850	VA67255-60
SUV113A	Variable	VF3578	VA113293-60
SUV113	Variable	VF4078	VA113293-60
SUV128	Variable	VF60100	VA1282125-60
SUV152	Variable	VF80125	VA1522125-60
SUVXE1A	Flat	PFX16	PAVX140A
SUVXE2C	Flat	PFX16	PAVX156A
SUVXE1	Flat	PFX20	PAVX140A
SUVXE2B	Flat	PFX20	PAVX156A
SUVXE2A	Flat	PFX28	PAVX156A
SUVXE3B	Flat	PFX28	PAVX180A
SUVXE2	Flat	PFX40	PAVX156A
SUVXE3A	Flat	PFX40	PAVX180A
SUVXE3	Flat	PFX60	PAVX180A
SUVXE4B	Flat	PFX60	PAVX200A
SUVXE4A	Flat	PFX80	PAVX200A
SUVXE4	Flat	PFX100	PAVX200A





## FOGGING & HUMIDIFICATION

PAPER STORAGE • TEXTILE MILLS  
LIQUID STORAGE TANKS • AIR DUCTS  
PRODUCE STORAGE ROOMS  
GREENHOUSES • HATCHERIES  
CONCRETE PIPE CURING



# FOGGING & HUMIDIFICATION INTRODUCTION



## RELIABLE & COST-EFFECTIVE HUMIDIFICATION SOLUTIONS

For reliable, cost-effective humidification, we offer a wide selection of air atomizing nozzles for adding humidity to air, adding moisture to paint tanks to reduce sparking, moisturizing small spaces plus more. Complete humidification packages can be assembled to connect to existing air and fluid lines. We can provide everything you need except piping and wiring.



### PRODUCT RANGE

- **AirJet® Fogger Nozzles:** for high-quality fog in large open spaces, you'll find these nozzles offer operating flexibility, easy maintenance and dependable clog-free performance
- **MiniFogger® III:** in small and hard-to-reach spaces, the MiniFogger is ideal. Compact and lightweight, it fits in corners and installs easily on walls and ceilings to provide economical, efficient humidification
- **Air Atomizing Nozzles:** choose from siphon-fed or pressure-fed nozzles that provide efficient humidity and low-cost installation and operation
- **Wall-Mounted Humidification Units:** Self-contained unit includes multiple air atomizing nozzles and is ready to connect to existing air and liquid lines
- **Accessories:** a wide choice of accessories, including humidistats, switching relays, float boxes, float valves and pipe hangers are available

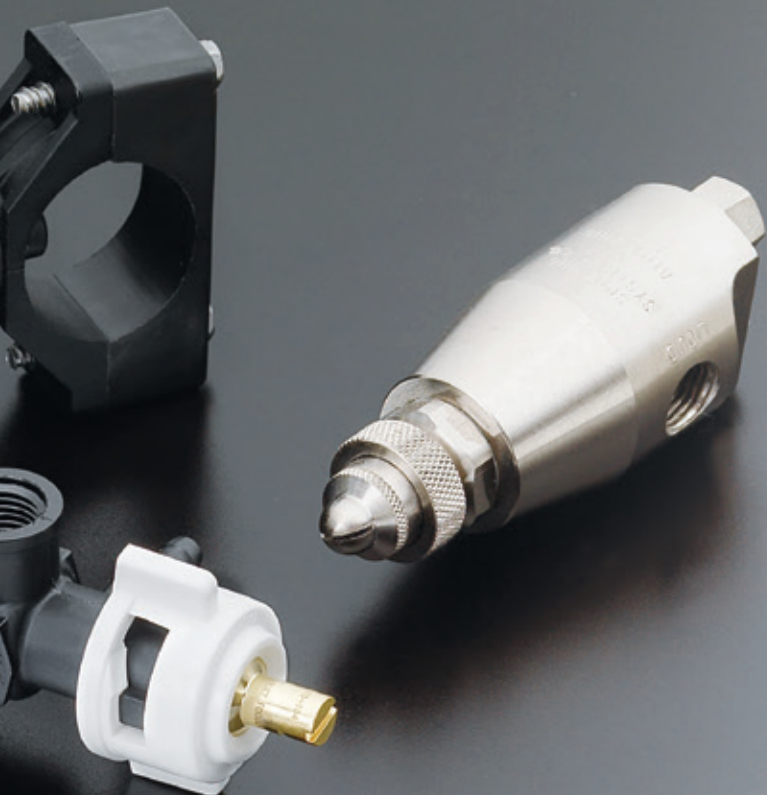

# FOGGING & HUMIDIFICATION TABLE OF CONTENTS



	PAGE
 <b>Quick Reference Guide</b>	<b>E4</b>
 45265 DripSafe™ AirJet® Fogger	E5
 45269 DripSafe AirJet Fogger	E5
 23412 AirJet Fogger	E6
 QJ25655 AirJet Fogger	E6
 YMF MiniFogger® III	E7
 45400 Humidification Unit	E8

NOTE: The products listed above are designed specifically for fogging and humidification applications. Other atomizing nozzles found elsewhere in this catalog can also be used for these applications. **Contact your local representative for additional applications assistance.**



**OVERVIEW: FOGGING & HUMIDIFICATION**

- Liquid and compressed air are mixed to produce a finely atomized spray for rapid evaporation and efficient humidification
- Drop size may be controlled by adjusting air and water pressure to create a wet or a dry fog, depending on application requirements
- Several configurations are available to produce flow rates up to 72 gph (272 lph)
- Nozzles are available that operate using normal municipal water pressure – without the use of high-pressure pumps
- A variety of nozzle bodies are available for convenient mounting and positioning

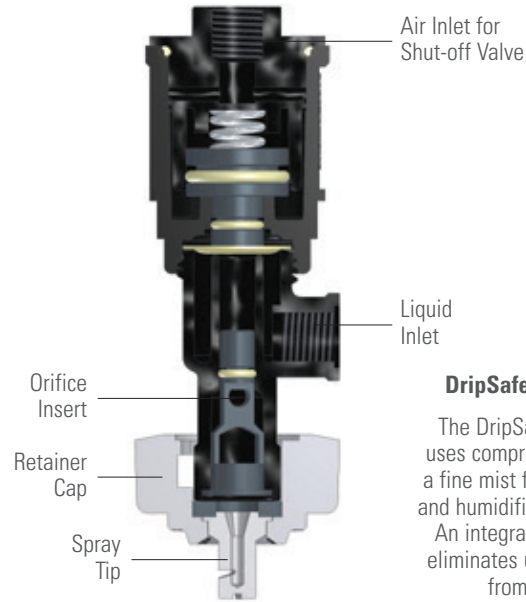

**DripSafe AirJet Fogger**

The DripSafe AirJet Fogger uses compressed air to create a fine mist for fogging, cooling and humidification applications. An integrated shut-off valve eliminates unwanted dripping from the nozzle.

**QUICK REFERENCE GUIDE**

Product Number	Connection Type	Max Flow
<b>45265 DripSafe™ AirJet® Fogger</b>	.290" (7.4 mm) hose shank for 1/4" air hose or tubing (atomizing air) 1/4" NPT or BSPT (shut-off valve air) 1/4" NPT or BSPT (liquid)	4.5 gph (17.0 lph)
<b>45269 DripSafe AirJet Fogger</b>	.290" (7.4 mm) hose shank for 1/4" air hose or tubing (atomizing air) 1/4" NPT or BSPT (shut-off valve air) Split-eyelet connection for 1/2", 3/4" or 1" liquid supply pipe	4.5 gph (17.0 lph)
<b>23412 AirJet Fogger</b>	.290" (7.4 mm) hose shank for 1/4" air hose or tubing (atomizing air) 1/4" NPT or BSPT (liquid)	7.9 gph (29.9 lph)
<b>QJ25655 AirJet Fogger</b>	.290" (7.4 mm) hose shank for 1/4" air hose or tubing (atomizing air) Split-eyelet connection for 1/2", 3/4" or 1" liquid supply pipe	7.9 gph (29.9 lph)
<b>YMF MiniFogger® III</b>	1/4" NPT or BSPT (air) 1/8" NPT or BSPT (liquid)	1.22 gpm (4.6 lpm)
<b>1/4JH</b>	1/4" NPT or BSPT (air and liquid)	72 gph (272 lph)
<b>1/4JT</b>	1/4" NPT or BSPT (air and liquid)	11.6 gph (43.9 lph)

**DRIPSAFE™ AIRJET® FOGGER NOZZLES**

- High quality, cost-efficient dry fog with average drop size of fifteen microns or less
- Drop size can be adjusted by changing the ratio of compressed air to water
- High-volume/high-efficiency air atomization is ideal for large/open structures and areas with high air exchange rates
- Drip safe air-actuated shut-off valve prevents liquid flow until air pressure at the nozzle is sufficient for fine atomization
- Flat spray tip has a large orifice that reduces clogging
- Spray set-up and built-in strainer are quickly removed by hand if cleaning is required
- Can use PVC pipe and low-pressure air tubing
- Operates using normal pressures found in municipal water systems, eliminates the need for expensive, high-pressure hydraulic pumps
- Spray tip is brass; valve and body are polymer
- Minimum air pressure range of 25 to 35 psi (1.7 to 2.5 bar)



**45265 AirJet Fogger** – Threaded 1/4" NPT or BSPT connection

**45269 AirJet Fogger** – Split-eyelet design provides fast installation of the nozzle onto the liquid supply pipe. No additional pipe fittings are required. Pipe cutting, threading and brazing are eliminated.

**PERFORMANCE DATA:  
45265 AND 45269 DRIPSAFE AIRJET FOGGER NOZZLES**

Water Pressure*	Fluid Orifice No. 16 (.016" Dia.)								Fluid Orifice No. 20 (.020" Dia.)								Fluid Orifice No. 26 (.026" Dia.)							
	Air Pressure*								Air Pressure*								Air Pressure*							
	10	20	30	40	50	60	70	80	10	20	30	40	50	60	70	80	10	20	30	40	50	60	70	80
20	1.2	1.1	–	–	–	–	–	–	3.1	1.7	–	–	–	–	–	–	3.3	1.8	–	–	–	–	–	–
	<b>1.5</b>	<b>2.5</b>	–	–	–	–	–	–	<b>1.4</b>	<b>2.8</b>	–	–	–	–	–	–	<b>1.3</b>	<b>2.4</b>	–	–	–	–	–	–
30	1.7	1.5	1.2	–	–	–	–	–	3.6	2.1	1.7	–	–	–	–	–	4.3	3.4	2.1	–	–	–	–	–
	<b>1.4</b>	<b>2.4</b>	<b>3.4</b>	–	–	–	–	–	<b>1.3</b>	<b>2.5</b>	<b>3.6</b>	–	–	–	–	–	<b>1.1</b>	<b>2.1</b>	<b>3.2</b>	–	–	–	–	–
40	2.0	1.7	1.5	1.4	–	–	–	–	4.3	3.1	2.2	–	–	–	–	–	–	4.5	3.6	2.4	–	–	–	–
	<b>1.4</b>	<b>2.4</b>	<b>3.3</b>	<b>4.2</b>	–	–	–	–	<b>1.2</b>	<b>2.3</b>	<b>3.4</b>	–	–	–	–	–	–	<b>1.9</b>	<b>2.8</b>	<b>3.9</b>	–	–	–	–

\*At the stated pressure in psi.

In each line, figures in plain face indicate water atomized in gph at psi water pressure. Figures in boldface indicate atomizing air in scfm at psi air pressure.

1. Values in red show optimum evaporation under normal room conditions, when center line of spray is 5' (1.5 m) from the lower surface.
2. Values in blue can require up to 10' (3 m) for evaporation. Other values may be used where extended heat or higher air velocity exist or where slight surface wetting is permitted.
3. AirJet Fogger has a horizontal throwing distance of 15' (4.5 m) and will expand to approximately 8' (2.4 m) wide and 3' (.9 m) thick.

**PLACING YOUR ORDER**

**Call 1.800.95.SPRAY for applications assistance or to place an order.**

**AIRJET® FOGGER NOZZLES**

- High quality, cost-efficient dry fog with average drop size of fifteen microns or less
- Drop size can be adjusted by changing air and water pressures
- High-volume/high-efficiency air atomization is ideal for large/open structures and areas with high air exchange rates
- Built-in check valve, spray tip and internal strainer can be quickly serviced without tools
- Flat spray tip has a large orifice that reduces clogging
- Can use PVC pipe and low-pressure air tubing
- Operates using normal pressures found in municipal water systems, eliminates the need for expensive, high-pressure hydraulic pumps
- Spray tip is brass; valve and body are polymer
- Minimum water pressure of 30 psi (2 bar) required for check valve



**23412 AirJet Fogger** – Threaded 1/4" NPT or BSPT connection

**QJ25655 AirJet Fogger** – Split-eyelet design provides fast installation of the nozzle onto the liquid supply pipe. No additional pipe fittings are required. Pipe cutting, threading and brazing are eliminated.

**PERFORMANCE DATA:**

**23412 AND QJ25655 AIRJET FOGGER NOZZLES**

\*At the stated pressure in psi.

Water Pressure*	Fluid Orifice No. 16 (.016" Dia.)								Fluid Orifice No. 20 (.020" Dia.)								Fluid Orifice No. 26 (.026" Dia.)							
	Air Pressure*								Air Pressure*								Air Pressure*							
	10	20	30	40	50	60	70	80	10	20	30	40	50	60	70	80	10	20	30	40	50	60	70	80
20†	1.2	1.1	–	–	–	–	–	–	3.1	1.7	–	–	–	–	–	–	3.3	1.8	–	–	–	–	–	–
	<b>1.5</b>	<b>2.5</b>	–	–	–	–	–	–	<b>1.4</b>	<b>2.8</b>	–	–	–	–	–	–	<b>1.3</b>	<b>2.4</b>	–	–	–	–	–	–
30	1.7	1.6	1.2	–	–	–	–	–	3.6	2.1	1.7	–	–	–	–	–	4.3	3.4	2.1	–	–	–	–	–
	<b>1.4</b>	<b>2.4</b>	<b>3.4</b>	–	–	–	–	–	<b>1.3</b>	<b>2.5</b>	<b>3.6</b>	–	–	–	–	–	<b>1.1</b>	<b>2.1</b>	<b>3.2</b>	–	–	–	–	–
40	2.0	1.6	1.5	1.4	–	–	–	–	4.3	3.1	2.2	–	–	–	–	–	–	4.5	3.6	2.4	–	–	–	–
	<b>1.4</b>	<b>2.4</b>	<b>3.3</b>	<b>4.2</b>	–	–	–	–	<b>1.2</b>	<b>2.3</b>	<b>3.4</b>	–	–	–	–	–	–	<b>1.9</b>	<b>2.8</b>	<b>3.9</b>	–	–	–	–
50	2.1	1.9	1.7	1.5	1.3	–	–	–	4.9	3.7	3.1	2.3	–	–	–	–	–	5.3	4.6	3.7	2.5	0.9	–	–
	<b>1.4</b>	<b>2.3</b>	<b>3.2</b>	<b>4.2</b>	<b>5.0</b>	–	–	–	<b>1.2</b>	<b>2.2</b>	<b>3.2</b>	<b>4.2</b>	–	–	–	–	–	<b>1.8</b>	<b>2.7</b>	<b>3.6</b>	<b>4.7</b>	<b>5.9</b>	–	–
60	2.3	2.1	1.9	1.7	1.4	1.3	0.8	–	–	4.3	3.7	3.1	2.2	–	–	–	–	6.1	5.4	4.7	3.8	2.8	1.3	–
	<b>1.3</b>	<b>2.3</b>	<b>3.2</b>	<b>4.1</b>	<b>5.0</b>	<b>5.8</b>	<b>6.8</b>	–	–	<b>2.1</b>	<b>3.0</b>	<b>3.9</b>	<b>5.0</b>	–	–	–	–	<b>1.7</b>	<b>2.5</b>	<b>3.4</b>	<b>4.4</b>	<b>5.4</b>	<b>6.7</b>	–
70	2.6	2.4	2.2	1.9	1.7	1.7	1.5	1.0	–	4.8	4.3	3.6	3.1	2.1	–	–	–	–	6.2	5.5	4.8	4.0	3.0	1.7
	<b>1.3</b>	<b>2.3</b>	<b>3.1</b>	<b>4.0</b>	<b>4.9</b>	<b>5.7</b>	<b>6.7</b>	<b>7.6</b>	–	<b>2.0</b>	<b>2.9</b>	<b>3.8</b>	<b>4.8</b>	<b>5.9</b>	–	–	–	–	<b>2.4</b>	<b>3.3</b>	<b>4.2</b>	<b>5.1</b>	<b>6.2</b>	<b>7.4</b>
80	2.7	2.6	2.4	2.2	2.0	1.9	1.7	1.6	–	5.3	4.9	4.2	3.7	3.1	2.2	–	–	–	6.8	6.2	5.5	4.8	4.1	3.1
	<b>1.3</b>	<b>2.2</b>	<b>3.1</b>	<b>4.0</b>	<b>4.9</b>	<b>5.7</b>	<b>6.6</b>	<b>7.5</b>	–	<b>1.9</b>	<b>2.7</b>	<b>3.6</b>	<b>4.6</b>	<b>5.6</b>	<b>6.7</b>	–	–	–	<b>2.3</b>	<b>3.2</b>	<b>4.1</b>	<b>5.0</b>	<b>5.9</b>	<b>7.0</b>
90	2.9	2.8	2.6	2.4	2.2	2.0	1.9	1.9	–	–	5.4	4.9	4.3	3.6	3.1	–	–	–	7.4	6.9	6.3	5.6	5.0	4.3
	<b>1.2</b>	<b>2.1</b>	<b>3.1</b>	<b>3.9</b>	<b>4.7</b>	<b>5.7</b>	<b>6.5</b>	<b>7.5</b>	–	–	<b>2.6</b>	<b>3.5</b>	<b>4.4</b>	<b>5.4</b>	<b>6.5</b>	–	–	–	<b>2.2</b>	<b>3.0</b>	<b>3.9</b>	<b>4.8</b>	<b>5.6</b>	<b>6.6</b>
100	3.1	3.0	2.8	2.6	2.4	2.3	2.2	2.2	–	–	5.8	5.3	4.8	4.3	3.7	3.1	–	–	7.9	7.4	6.9	6.3	5.7	5.0
	<b>1.2</b>	<b>2.1</b>	<b>3.0</b>	<b>3.9</b>	<b>4.7</b>	<b>5.6</b>	<b>6.5</b>	<b>7.5</b>	–	–	<b>2.5</b>	<b>3.3</b>	<b>4.3</b>	<b>5.3</b>	<b>5.9</b>	<b>7.3</b>	–	–	<b>2.1</b>	<b>2.9</b>	<b>3.8</b>	<b>4.6</b>	<b>5.5</b>	<b>6.4</b>

\*†For applications with liquid pressures below 30 psi (2 bar), request end cap sub-assembly 21950-20-NYB.

In each line, figures in plain face indicate water atomized in gph (l/h) at psi (bar) water pressure. Figures in boldface indicate atomizing air in scfm (NI/min) at psi (bar) air pressure.

1. Values in red show optimum evaporation under normal room conditions, when center line of spray is 5' (1.5 m) from the lower surface.
2. Values in blue can require up to 10' (3 m) for evaporation. Other values may be used where extended heat or higher air velocity exist or where slight surface wetting is permitted.
3. AirJet Fogger has a horizontal throwing distance of 15' (4.5 m) and will expand to approximately 8' (2.4 m) wide and 3' (.9 m) thick.

**PLACING YOUR ORDER**

**Call 1.800.95.SPRAY for applications assistance or to place an order.**



**YMF MINIFOGGER® III**

- High quality, cost-efficient dry fog with drop sizes seven to ten microns
- Compact design of 4.5" (115 mm) tall ideal for humidification applications with limited space
- Can be easily installed on a header, on a wall or on a ceiling
- Available with up to four stainless steel spray nozzle set-ups, each with automatic spray pattern alignment
- Choice of spray set-ups provide flow rates ranging from 0.24 to 1.22 gph (0.9 to 4.6 l/hr)
- 0.46 lbs. (210 g) for single spray set-up type; 0.55 lbs. (250 g) for multiple four set-up types
- Body, retainer cap and tank constructed of corrosion-resistant polypropylene with stainless steel air and water inlet connections
- Materials compatible with deionized water
- Easy to maintain – no tools required



**PERFORMANCE DATA:**  
**YMF MINIFOGGER III**

\*At the stated pressure in psi.

Spray Set-up No.	Air Capacity (standard cubic feet per minute)*			Flow Rate Capacity (gallons per hour and liters per hour)*			Sauter Mean Dia. (µm)		
	36 psi	44 psi	58 psi	36 psi	44 psi	58 psi	36 psi	44 psi	58 psi
SU1.0N	1.1	1.2	1.6	.24	.26	.29	8.5	7.6	6.7
SU2.5N				.61	.66	.69	9.6	8.5	7.6
SU3.0N				.74	.79	.85	9.8	9.0	8.4
SU4.3N				1.06	1.14	1.22	12.2	11.6	10.8

The standard MiniFogger III has four spray set-ups. Single spray set-ups are available. Contact your local representative for more information.

**PLACING YOUR ORDER**

---

**Call 1.800.95.SPRAY for applications assistance or to place an order.**

**OTHER FOGGING AND HUMIDIFICATION OPTIONS**

**45400 Humidification Unit**

- A self-contained humidifier suitable for use with deionized water
- Easy to install on a wall or for use in non-ducted applications
- Air regulator and gauge, 24VDC air control solenoid and air line filter are included
- Wall-mounting bracket is also provided
- For each spray set-up, water capacity ranges from 2.7 lbs/hr at 10 psi (0.7 bar) air to 6.5 lbs/hr at 60 psi (4 bar) air
- 9.7 lbs. (4.4 kg)



**PLACING YOUR ORDER**

**Call 1.800.95.SPRAY for applications assistance  
or to place an order.**

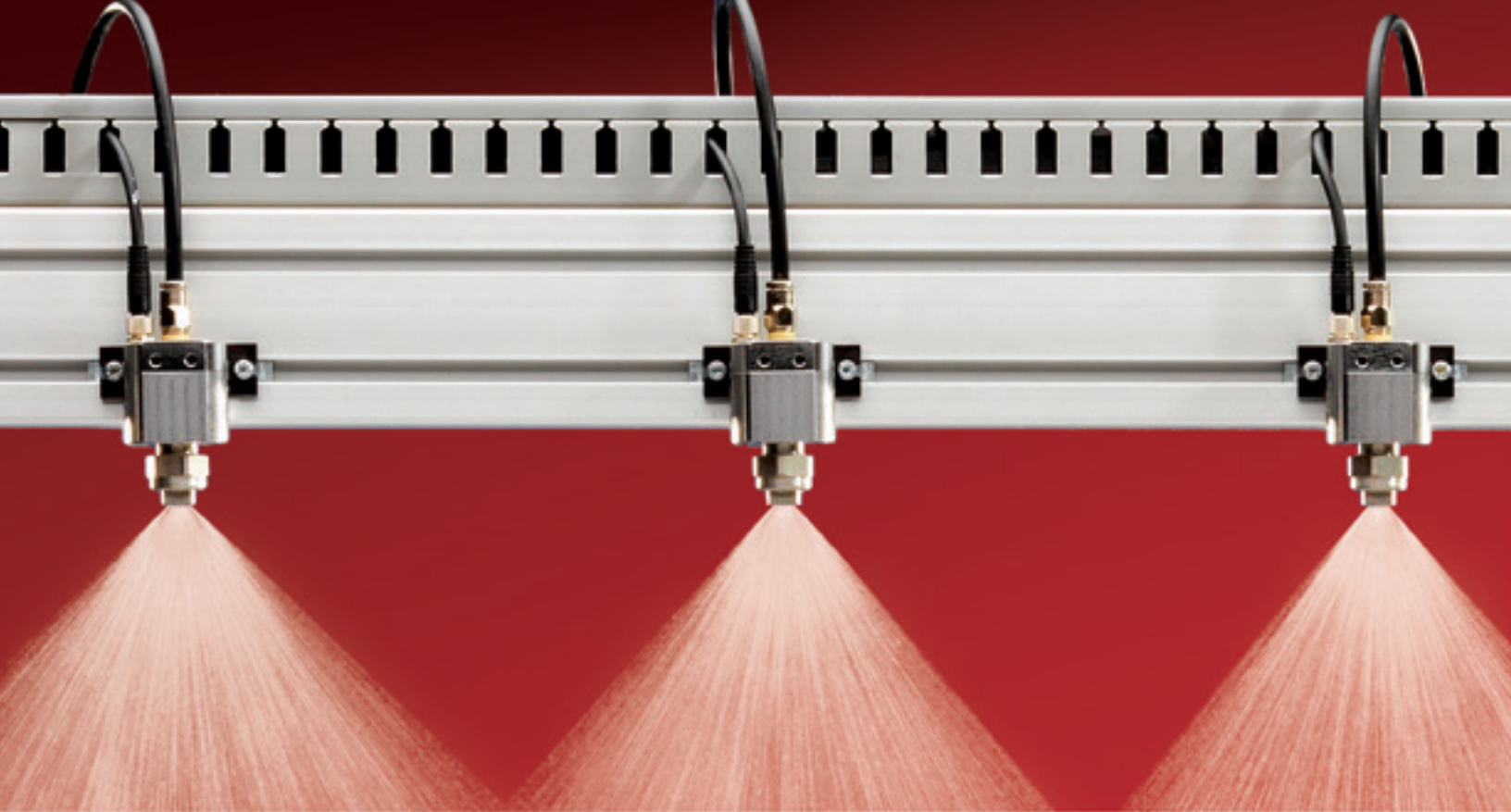

## SPRAY MANIFOLDS

FOOD PRODUCT COATING  
MOISTENING • TABLET COATING  
SPRAYING VISCOUS LIQUIDS  
LUBRICATION • WAX COATING



# SPRAY MANIFOLDS INTRODUCTION



## SIMPLE INSTALLATION & PEAK SPRAY PERFORMANCE

Proper positioning and mounting are critical to ensure optimum spray performance of your spray nozzles. Standard spray manifolds are available in a variety of configurations to meet your exact requirements. Save time and eliminate integration problems using our single source solutions.



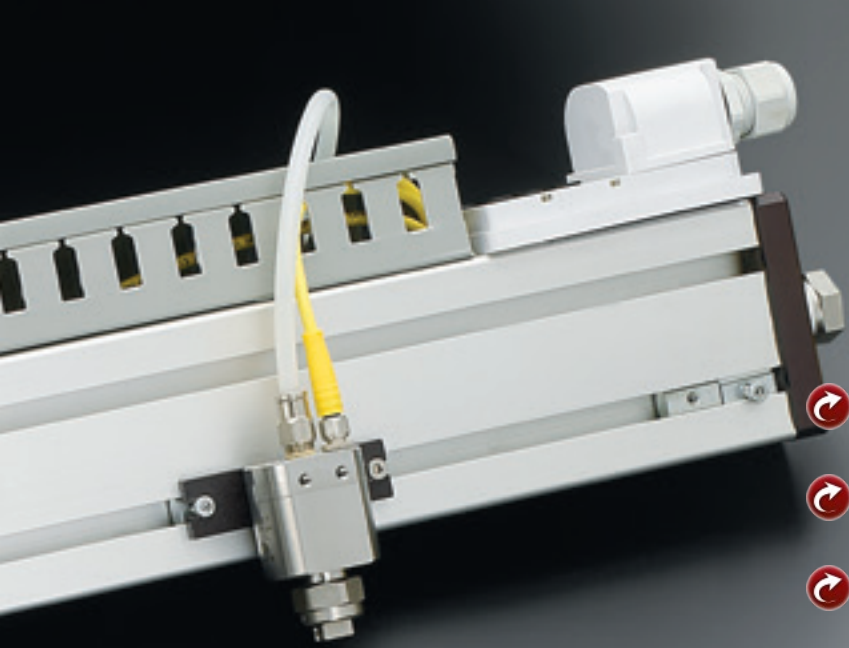

# SPRAY MANIFOLDS TABLE OF CONTENTS

	PAGE
 <b>Quick Reference Guide</b>	<b>F4</b>
 53500 Modular Air Atomizing Spray Manifold	F5
 54000 Modular Air Atomizing Spray Manifold	F5
 54500 Modular Air Atomizing Spray Manifold	F5
 63600 Sanitary Spray Manifold	F5
 98250 Spray Manifold	F6



**OVERVIEW: SPRAY MANIFOLDS**

- Spray manifolds are available for a wide variety of spray applications
- Threaded or sanitary inlet connections
- Hydraulic or atomizing nozzles can be used
- Nozzle spacing as narrow as 2" (51 mm)
- Manifold lengths up to 20' (6 m)
- A variety of materials of construction
- Heated manifolds available

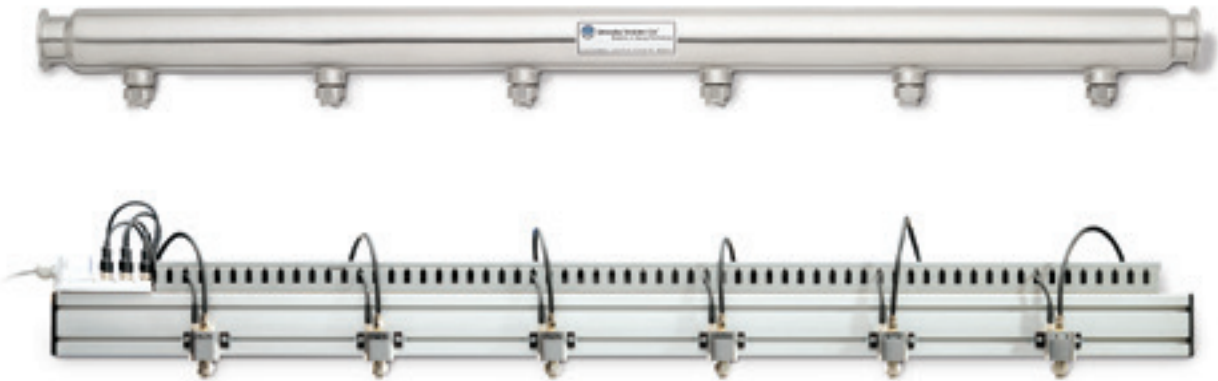

**QUICK REFERENCE GUIDE**

Product	Connection Type	Nozzle Spacing	Max Manifold Length	Materials of Construction	Hydraulic or Air Atomizing	Spray Nozzle Series
<b>53500 Modular Manifold</b>	Threaded	Min – 2" (51 mm) Max – 9" (229 mm)	11' (3.4 m)	316 stainless, polypropylene	Air Atomizing	JAU, VMAU
<b>54000 Modular Manifold</b>	Threaded or sanitary flange	Min – 2" (51 mm) Max – 9" (229 mm)	5' (1.5 m)	316L, PTFE	Air Atomizing	JAU, VMAU
<b>54500 Modular Manifold</b>	Sanitary Flange	6" or 9" (152 mm or 229 mm)	5' (1.5 m)	Stainless steel	Air Atomizing	VMAU
<b>63600 Sanitary Manifold</b>	Sanitary Flange	Min 2" (51 mm) with J, JAU Min 3" (76 mm) with PulsaJet, VMAU	–	Sanitary 316L tubing	Both Available	J, JAU, VMAU, PulsaJet®, JAUCO, JAUMCO
<b>98250 Manifold</b>	Threaded	Adjustable	20' (6.1 m)	Aluminum	Both Available	PulsaJet



SPRAY MANIFOLD OPTIONS

**53500, 54000, 54500 Modular Air Atomizing Manifolds**

- Lightweight design for fast, easy set-up and maintenance
- Streamlines tubing and fittings; simplifies cleaning
- Easy disassembly and reassembly to minimize downtime
- Designs available for industrial, food processing and pharmaceutical applications
- 54500 manifold is heated for use with viscous liquids



**63600 Sanitary Manifolds**

- Lightweight for easy installation and removal
- Sanitary 316L tubing with polished outside surfaces
- Large diameter liquid passages with minimal pressure drop to help ensure consistent flow
- Available for hydraulic or air atomizing nozzles
- Optional hot water jacket to improve flow of viscous coatings



**PLACING YOUR ORDER**

**Call 1.800.95.SPRAY for applications assistance or to place an order.**

## SPRAY MANIFOLD OPTIONS

**98250 Manifold**

- Compact design with rigid aluminum structure also functions as fluid passage
- Can be configured with flexible lengths, number of nozzles and nozzle spacing
- Dual inlet ports can be used for liquid recirculation
- Standard wetted components constructed of aluminum, rubber, Buna, nickel-plated brass and nylon tubing

**PLACING YOUR ORDER**

Call 1.800.95.SPRAY for applications assistance  
or to place an order.





# ACCESSORIES



# ACCESSORIES INTRODUCTION



## OPTIMIZE PERFORMANCE AND SIMPLIFY INSTALLATION

### Clog Prevention

- Liquid strainers
- Filtration assemblies
- Air line filters

### Ensure Proper Flow Control and Regulation

- Solenoid valves, pressure relief valves and more
- Air pressure regulators
- Liquid pressure regulators

### Simplify Nozzle Mounting and Positioning

- Split-eyelet connectors
- Swivels
- Fittings

### SIMPLIFY INSTALLATION, OPERATION AND MAINTENANCE:



Prevent particles and debris from obstructing flow with nozzle and fluid line strainers. Choose from a wide range of inlet connections, materials, mesh size and more. **See page G4**



Regulate liquid pressure from 5 to 125 psi (0.3 to 8.5 bar) with our durable diaphragm-type non-relieving liquid regulators. Choose from a wide range of materials. **See page G12**



Connect nozzles to pipes in minutes with leak-proof split-eyelet connectors. Connectors clamp on 1/4" to 4" pipes. **See page G19**

# ACCESSORIES TABLE OF CONTENTS



## LIQUID STRAINERS

	PAGE
TWD, 16106, 9830 and AA122 Strainers	G4
AA124/AA430 Strainers	G5

## AIR LINE FILTERS

	PAGE
11438 Filters	G9

## LIQUID PRESSURE GAUGES

	PAGE
26383 and 26385 Gauges	G11

## LIQUID AND AIR PRESSURE REGULATORS

	PAGE
11438 Regulators	G12

## SOLENOID VALVES

	PAGE
2-Way and 3-Way Valves	G14

## BALL VALVES

	PAGE
AA(B)344M Valves	G16

## PLUG VALVES

	PAGE
23220 Valves	G17

## MOUNTING & POSITIONING ACCESSORIES

	PAGE
Extensions	G18
Split-Eyelet Connectors	G19
Mounting Kits	G21
Spray Pipe Assembly	G21
Pipe Hanger	G22
Wall Mount Adapters	G22

## OTHER ACCESSORIES

	PAGE
Pressure Tanks	G23
Float Box and Valve	G23
Level Switches	G24
Adjustable Siphon Injector	G25



**OVERVIEW: LIQUID STRAINERS**

- Liquid strainers protect nozzles, valves and pumps from damaging debris and minimize clogging
- Wire mesh options ensure screening of particulate as small as 63 microns

**T-Style Strainer**

T-strainers feature a removable bottom cap or plug for complete withdrawal of the screen assembly during cleaning. On some models, the bottom pipe plug can be replaced with a drain cock for quick-flush cleaning. Models with a clear nylon bowl allow easy visual inspection of the internal screen. Self-clean designs allow filtered liquid to pass through, while liquid particles are returned back to the liquid supply through a return outlet.

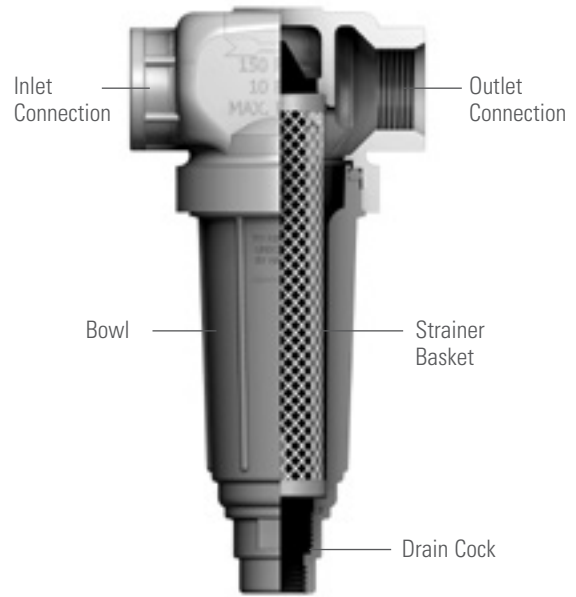

**STRAINER OPTIONS**

**TWD**

- 1/4", 3/8", 1/2", 3/4", 1", 1-1/4", 1-1/2", 2", 2-1/2" female conn.
- Removable bottom plug for easy screen cleaning
- Bottom plug can be replaced with drain cock for flush cleaning
- Max. pressure: 300 psi (20 bar)
- Materials: Brass, stainless steel
- Mesh: 16, 30, 50, 80, 100, 40 x 200 Dutch weave



**16106**

- 1-1/2", 2", 2-1/2" female conn.
- Removable bottom plug for easy screen cleaning
- Bottom plug can be replaced with drain cock for flush cleaning
- Max. pressure: 200 psi (14 bar)
- Materials: Brass, stainless steel
- Mesh: 16, 50, 80, 100



**9830**

- 3/4", 1" female conn.
- Hand removable ribbed bottom cap for easy cleaning of screen
- Max. pressure: 300 psi (20 bar)
- Materials: Aluminum, brass, ductile iron
- Mesh: 16, 50, 100



**AA122**

- 1/2", 3/4" female conn.
- Hand removable outer bowl for easy screen cleaning
- Max. pressure: 150 psi at 100°F (10 bar at 38°C)
- Materials: Polypropylene, polypropylene head with clear nylon bowl
- Mesh: 15, 30, 50, 80, 100, 200, 40 x 200 Dutch weave



STRAINER OPTIONS

**AA124/AA430**

- 3/4", 1", 1-1/4", 1-1/2", 2", 2-1/2" female conn. (Inlet connections vary. See pages G7 and G8.)
- Larger size screen area requires less frequent cleaning
- Self-cleaning styles and versions with mounting lugs available
- AA124 and AA430 versions are the same except for materials and inlet connections



Strainer Type	Strainer Part No.	Material*	Max. Pressure	Mesh Sizes
124	AA124-AL	Aluminum head/nylon bowl	150 psi (10 bar)	16, 30, 50, 80, 100
124ML with mounting holes**	AA124ML-AL	Aluminum head/nylon bowl	150 psi (10 bar)	16, 30, 50, 80, 100
124A self-cleaning version	AA124ASC-NYB	Aluminum head/nylon bowl	110 psi (8 bar)	16, 30, 50, 80, 100
430ML with mounting holes**	AA430ML	Polypropylene head/nylon bowl	110 psi (8 bar)	16, 30, 50, 80, 100, 120, 200***
430 self-cleaning version	AA430SC	Polypropylene head/nylon bowl	75 psi (5 bar)	16, 30, 50, 80, 100, 120, 200***

\* Max. temperature for plastic 100°F (38°C); max. temperature for metal 180°F (82°C).

\*\* For mounting on machinery or angle iron.

\*\*\* 120 only for 1-1/4" and 1-1/2" sizes; 200 only for 3/4" and 1" sizes.

MESH SELECTION GUIDE

Mesh Size	Wire Dia. (in.)	Mesh Opening (in.)	Mesh Opening (microns)	Percentage Open Area	Orifice Dia. (in.)
16	0.016	0.045	1143	55.4	0.032 and larger
20	0.016	0.0340	864	46.2	0.032 and larger
30	0.012	0.0213	541	40.8	0.032 and larger
50	0.009	0.0110	279	30.3	0.032 and larger
60	0.0075	0.0092	234	30.5	0.019 through 0.031
80	0.0055	0.0070	177	31.4	0.019 through 0.031
100	0.0045	0.0055	140	30.3	0.019 through 0.031
120	0.0037	0.0046	118	30.1	0.019 through 0.031
200	0.0021	0.0029	74	33.6	Up through 0.018
40 x 200 Dutch Weave	0.007 x 0.005	0.003	63	—	Up through 0.018

MATERIAL OPTIONS

Material	Code
Aluminum	AL
Brass	B
Ductile Iron	No code
Nylon	NYB
Polypropylene	PP
Polypropylene head/clear nylon bowl	NYC
303 stainless steel	SS
316 stainless steel	316SS

PLACING YOUR ORDER

Call 1.800.95.SPRAY for application assistance or to place an order.



## ORDERING INFORMATION

## TWD STRAINER

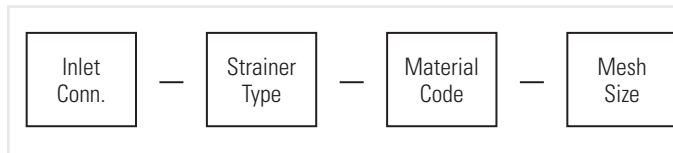

## EXAMPLE



BSPT connections require the addition of a "B" prior to the inlet connection.

## 16106 STRAINER

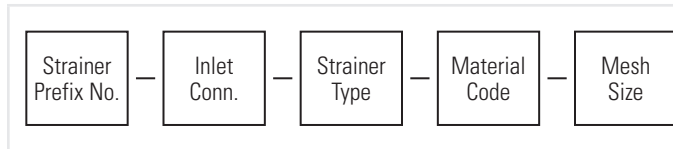

## EXAMPLE



BSPT connections require the addition of a "B" prior to the inlet connection.

## 9830 STRAINER

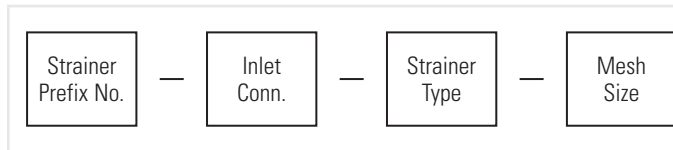

## EXAMPLE



BSPT connections require the addition of a "B" prior to the inlet connection.

## AA122 STRAINER

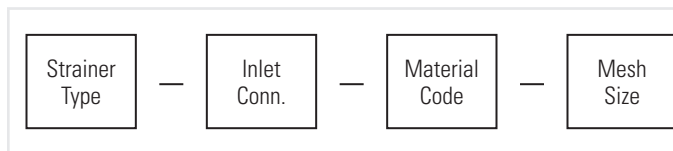

## EXAMPLE



BSPT connections require the addition of a "B" prior to the inlet connection.

## AA124/AA430 SELF-CLEANING STRAINER

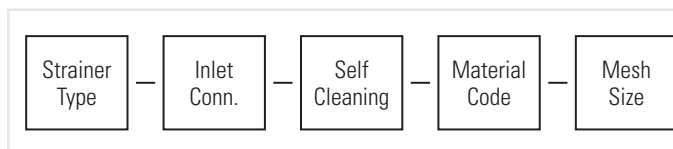

## EXAMPLE



BSPT connections require the addition of a "B" prior to the inlet connection.

## PLACING YOUR ORDER

Call **1.800.95.SPRAY** for application assistance  
or to place an order.

DIMENSIONS AND WEIGHTS

Strainer	Accessory Type	Inlet Conn. (in.)	L (in.)	W (in.)	A (in.)	B (in.)	C (in.)	Net Weight (oz.)
	TWD	1/4	3.922	2.500	–	3.235	–	24.9
		3/8	4.905	3.250	–	3.965	–	28.2
		1/2	4.905	3.250	–	3.965	–	28.2
		3/4	7.535	4.500	–	6.225	–	80.4
		1	7.535	4.500	–	6.225	–	76.7
		1-1/4	10.320	6.000	–	8.380	–	190.2
		1-1/2	10.320	6.000	–	8.380	–	183.5
		2	12.365	8.000	–	9.805	–	357.8
2-1/2	12.365	8.000	–	9.805	–	334.1		
	16106	1-1/2	9.0	7.250	–	7.240	–	188.9
		2	11.310	9.250	–	8.940	–	416.2
		2-1/2	11.310	9.250	–	8.940	–	392.9
	9830	3/4	8.180	5.250	–	7.187	–	140.6
		1	8.180	5.250	–	7.187	–	136.8
	AA122	1/2	4.014	3.063	–	3.625	–	3.4
		3/4	4.014	3.063	–	3.625	–	3.2
	AA124	1-1/4	9.400	5.344	–	8.020	–	77.2
		1-1/2	9.400	5.344	–	8.020	–	76.9
		2	12.000	7.438	–	10.000	–	215.2
		2-1/2	12.000	7.438	–	10.000	–	204.9

Based on the largest/heaviest version of each type.

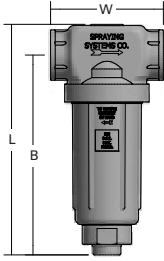
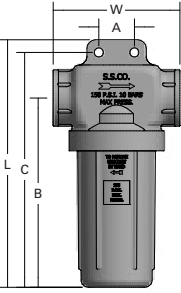
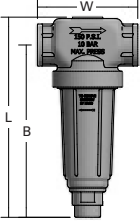
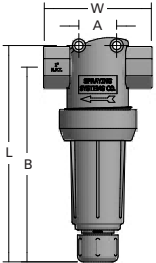
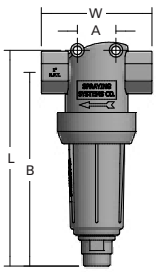

DIMENSIONS AND WEIGHTS

Strainer	Accessory Type	Inlet Conn. (in.)	L (in.)	W (in.)	A (in.)	B (in.)	C (in.)	Net Weight (oz.)
	AA124SC	1-1/4	8.750	5.343	–	7.355	–	53.3
		1-1/2	8.750	5.343	–	7.355	–	52.2
	AA124ML	3/4	7.953	4.188	1	5.891	7.453	31.0
		1	7.953	4.188	1	5.891	7.453	30.3
		1-1/4	9.688	5.344	1.5	7.234	9.156	41.6
		1-1/2	9.688	5.344	1.5	7.234	9.156	39.2
		2	14.480	7.438	2.375	11.234	13.855	107.9
		2-1/2	14.480	7.375	2.375	11.234	13.855	103.0
	AA124ASC	3/4	8.325	4.188	–	7.170	–	52.5
		1	8.325	4.188	–	7.170	–	50.4
	AA430ML	3/4	8.855	4.510	1.575	7.955	–	15.2
		1	8.855	4.510	1.575	7.955	–	14.1
		1-1/4	11.791	5.600	1.535	10.534	–	32.5
		1-1/2	11.791	5.600	1.535	10.534	–	33.2
	AA430MLSC	3/4	8.738	4.510	1.575	7.838	–	21.9
		1	8.738	4.510	1.575	7.838	–	21.2
		1-1/4	11.816	5.600	1.535	10.561	–	31.0
		1-1/2	11.816	5.600	1.535	10.561	–	31.7

Based on the largest/heaviest version of each type.





**AIR LINE FILTERS**

- Air line filters protect equipment from corrosion and excessive wear by removing liquid and contaminants from air lines
- Manual drain air line filter – simple petcock at the bottom of the bowl enables manual drainage; filter is easily accessible
- Automatic drain air line filter – for use in inaccessible locations; a float-operated mechanism automatically expels liquid when over a critical level
- 1/4", 3/8", 1/2", 3/4", 1" female conn.
- 50 micron filter element
- Max. pressure: 150 psi (10 bar)
- Max. temperature: 125°F (50°C)



11438 Air Line Filter

**AIR LINE FILTER SELECTION GUIDE**

Air Line Filter No.	Air Line Filter Type		Inlet Conn. (in.)	Approx. Flow at 100 psi*	
	Manual	Automatic		scfm	lpm
11438-1	•		1/4	50	1415
11438-2	•		3/8	50	1415
11438-3	•		1/2	150	4250
11438-4	•		3/4	345	9770
11438-5	•		1	445	12600
11438-16		•	1/4	50	1415
11438-17		•	1/2	150	4250
11438-19		•	1	445	12600

\*With 5 psi pressure drop through filter.

11438-1, -2, -3, -16 and -17 have screw-on transparent polycarbonate bowls with bowl guards to prevent breakage. Not suitable for use in systems with air compressors lubricated with fire-resistant synthetics.

**PLACING YOUR ORDER**

**Call 1.800.95.SPRAY for application assistance or to place an order.**



**ORDERING INFORMATION**

**11438 AIR LINE FILTER**

<div style="border: 1px solid black; padding: 5px; display: inline-block;">Air Line Filter No.</div>	<p>EXAMPLE</p> <div style="border: 1px dashed black; padding: 5px; display: inline-block; margin: 10px auto;">11438-1</div>
--	---

BSPT connections require the addition of a "B" prior to the inlet connection.

**DIMENSIONS AND WEIGHTS**

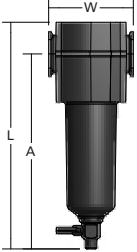
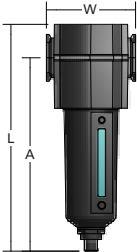
Air Line Filter	Accessory Type	Inlet Conn. (in.)	L (in.)	W (in.)	A (in.)	Net Weight (oz.)
	<b>11438-1</b>	1/4	6.625	2.750	5.938	21.1
	<b>11438-2</b>	3/8	6.625	2.750	5.938	17.7
	<b>11438-3</b>	1/2	7.375	3.906	6.688	28.8
	<b>11438-4</b>	3/4	11.500	4.750	10.438	18.4
	<b>11438-5</b>	1	11.500	4.750	10.438	73.8
	<b>11438-6</b>	1-1/2	17.563	8.220	15.700	24
	<b>11438-16</b>	1/4	7.000	3.625	6.313	21.1
	<b>11438-17</b>	1/2	7.000	3.453	6.313	29.4
	<b>11438-19</b>	1	11.125	4.750	10.063	73.3

Based on the largest/heaviest version of each type.

**PLACING YOUR ORDER**

**Call 1.800.95.SPRAY for application assistance or to place an order.**

**LIQUID PRESSURE GAUGES**

- Easy-to-read gauges with bottom inlet connection or center back connection
- Patented spring-suspended movement protected by a corrosion- and impact-resistant ABS housing with polycarbonate window
- Dual scales: psi and bar
- Grade B accuracy within  $\pm 2\%$  in the middle 50% of the scale, with 3% accuracy in the high and low ends of the scale
- 0 psi to a maximum of 300 psi (0 bar to a maximum of 20 bar)
- Materials: All wetted parts are brass; combination brass/bronze connection and bourdon tube

**GAUGE OPTIONS**

**26383**

- 1/8", 1/4" center back male conn.
- 2" (51 mm) dia. housing



**26385**

- 1/4" bottom male conn.
- 2-1/2" (64 mm) dia. housing



**ORDERING INFORMATION**

**PRESSURE GAUGE 26383**

Gauge Type	—	Inlet Conn.	—	Pressure Rating (psi)
------------	---	-------------	---	-----------------------

EXAMPLE

26383	—	1/8	—	60
-------	---	-----	---	----

Pressure rating is ordered in psi.

**PRESSURE GAUGE 26385**

Gauge Type	—	Pressure Rating (psi)
------------	---	-----------------------

EXAMPLE

26385	—	60
-------	---	----

Pressure rating is ordered in psi.

**SPECIFICATIONS**

Gauge Type	Inlet. Conn. (in.) (M)	Pressure Rating psi (bar)	Pressure Range psi (bar)
26383	1/8, 1/4	60 (4)	0 – 60 (0 – 4)
	1/8, 1/4	100 (7)	0 – 100 (0 – 7)
	1/8, 1/4	160 (11)	0 – 160 (0 – 11)

Gauge Type	Inlet. Conn. (in.) (M)	Pressure Rating psi (bar)	Pressure Range psi (bar)
26385	1/4	60 (4)	15 – 45 (1.0 – 3.1)
	1/4	100 (7)	25 – 75 (1.7 – 5.2)
	1/4	160 (11)	40 – 120 (2.8 – 8.3)
	1/4	300 (21)	75 – 225 (5.2 – 15.5)

**LIQUID AND AIR PRESSURE REGULATORS**

- Diaphragm-type non-relieving liquid pressure regulators
  - Operating temperature range: 35° to 200°F (2° to 93°C)
  - Gauges supplied separately
- Diaphragm-type, relieving and non-relieving style air pressure regulators
  - Relieving style automatically relieves excessive air pressure in a regulated line; non-relieving types also available
  - Regulated line pressure can be reduced with adjusting knob even when line is dead ended
  - Operating temperature range: 0° to 175°F (-15° to +80°C) with dew point less than air temperatures below 35°F (2°C)
  - Gauges supplied separately

**REGULATOR OPTIONS**

**11438 Air Pressure Regulator**

- Diaphragm, relieving and non-relieving types
- Regulated pressures from 5 to 125 psi (0.3 to 8.5 bar) with supply line pressures up to 300 psi (20 bar)
- Materials: Die cast aluminum, stainless steel, zinc



**11438 Liquid Pressure Regulator**

- Non-relieving type
- Regulated pressures from 5 to 125 psi (0.3 to 8.5 bar) with primary supply line pressures
- Max. pressure: 400 psi (28 bar)
- Materials: Brass, brass-plated zinc or stainless steel



**ORDERING INFORMATION**

**AIR PRESSURE REGULATOR**

Regulator No.	EXAMPLE <b>11438-45</b>
---------------	----------------------------

**LIQUID PRESSURE REGULATOR**

Regulator No.	EXAMPLE <b>11438-250</b>
---------------	-----------------------------

**PLACING YOUR ORDER**

Call **1.800.95.SPRAY** for application assistance or to place an order.

SPECIFICATIONS

Regulator Type	Regulator Style	Regulator Number	Max. Pressure (psi)	Main Ports (in.)	Gauge Ports (in.)	Material
Air	Non-relieving	11438-35	300	1/4	1/4	Zinc
		11438-36	300	3/8	1/4	Zinc
		11438-37	300	1/2	1/4	Zinc
		11438-38	300	3/4	1/4	Aluminum
		11438-39	300	1	1/4	Aluminum
	Relieving	11438-45	300	1/4	1/4	Zinc
		11438-45S	300	1/4	1/8	316 stainless steel
		11438-46	300	3/8	1/4	Zinc
		11438-47	300	1/2	1/4	Zinc
		11438-47S	300	1/2	1/4	316 stainless steel
		11438-48	300	3/4	1/4	Aluminum
		11438-49	300	1	1/4	Aluminum
Liquid	Diaphragm	11438-250	400	1/4	1/4	Brass
		11438-251	400	3/8	1/4	Brass
		11438-252	400	1/2	1/4	Brass
		11438-253	400	3/4	1/8	Brass
		11438-254	400	1	1/8	Brass

Stainless steel versions meet NACE standard MR-01-75 for corrosion resistance.

DIMENSIONS AND WEIGHTS

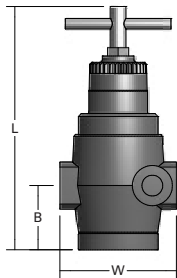
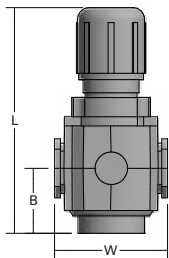
Regulator	Accessory Type 11438-	B (in.)	L (in.)	W (in.)	Net Weight (oz.)
	250, 251	1.500	5.750	2.750	42.7
	252	1.594	5.938	3.313	47.6
	253, 254	1.625	9.500	5.000	129.1
	35, 36, 45, 46	1.438	5.125	2.750	21.6
	37, 47	1.500	5.875	3.500	30.5
	38, 39, 48, 49	2.375	6.875	4.250	54.3
	45S	0.375	2.750	1.500	5.5
	47S	1.625	7.813	3.500	7.2

Based on the largest/heaviest version of each type.



## SOLENOID VALVES

- On/off flow control in automatically operated systems
- Dependable performance in air and liquid lines with temperatures from 40° to 165°F (5° to 75°C)
- Ten watt, class "F" coils are for continuous duty; UL and CSA approved; suitable for international use
- Encapsulated coil resists high humidity and fungus growth
- 360° rotation available with durable electrostatically powder-coated enclosure
- Stainless steel pilot orifice helps eliminate premature leaking and increases service life in high flow velocity situations
- Floating plungers automatically compensate for vibration, shock, wear and deformation while providing a bubble-tight seal
- Versatile mounting in any position; direct pipe mounting

## VALVE OPTIONS

**2-Way**

- 1/4", 3/8", 1/2", 3/4", 1" conn.
- Direct-acting poppet or pilot-operated diaphragm valve action
- Materials: Brass, stainless steel

**3-Way**

- 1/4", 3/8", 1/2" conn.
- Poppet or diaphragm valve action
- Materials: Brass, stainless steel



## ORDERING INFORMATION

## COMPLETE SOLENOID VALVE\*

Model No.

EXAMPLE

11438-20

BSPT connections require the addition of a "B" prior to the inlet connection

\*110 or 120 V, 50/60 Hz coil is standard. If other coil assemblies are desired, add the appropriate letter code to the end of the part number. For example: 11438-20A.

A = 220 or 240 V, 50/60 Hz    B = 24 V, 60 Hz    C = 12 VDC    D = 24 VDC

## PLACING YOUR ORDER

Call **1.800.95.SPRAY** for application assistance  
or to place an order.



## SPECIFICATIONS

Port Conn. (in.)	Valve Action	Valve Type	Model Number	Max. Pressure (psi)	Orifice Size (in.)	Cv Factor**	Body Material	Seal Material
1/4	Direct Acting Poppet	2-way	11438-20	60*	3/16	.50	Stainless steel	Viton®
1/4	Direct Acting Poppet	2-way	11438-21	205*	1/8	.28	Stainless steel	Kel-F®
3/8	Pilot-Operated Diaph.	2-way	11438-22	150*	7/16	2.5	Forged or cast brass	Buna-N
1/2	Pilot-Operated Diaph.	2-way	11438-23	150*	5/8	4.0	Forged or cast brass	Buna-N
3/4	Pilot-Operated Diaph.	2-way	11438-24	230	3/4	7.8	Forged or cast brass	Buna-N
1	Pilot-Operated Diaph.	2-way	11438-25	230	1	13.0	Forged or cast brass	Buna-N
1/4	Poppet	3-way	11438-30	100	3/32	.25/.38	Forged or cast brass	Viton
1/2	Diaph.	3-way	11438-31	150	1/2	3.6	Forged or cast brass	Buna-N
3/8	Diaph.	3-way	11438-32	150	7/16	1.6/2.5	Aluminum	Buna-N

\*For maximum pressures of coils "C" and "D", request Data Sheet 11438 – Solenoid (1).

See Trademark Registration and Ownership, page i1.

\*\*For use of Cv Factor, request Data Sheet 11438 – Solenoid (2).

## DIMENSIONS AND WEIGHTS

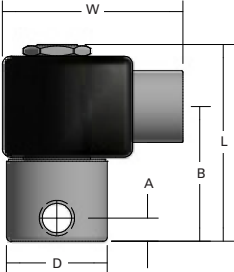
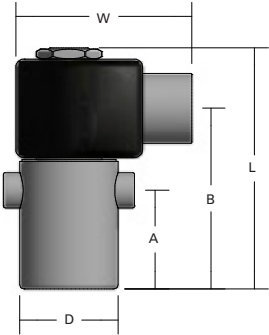
Solenoid Valve	Accessory Type	A (in.)	B (in.)	D (Dia.) (in.)	L (in.)	W (in.)	Net Weight (oz.)
	<b>11438-20</b>	0.344	1.938	1.625	2.906	2.76	20.3
	<b>11438-21</b>	0.344	1.938	1.625	2.906	2.76	20.3
	<b>11438-22</b>	0.594	2.594	1.969	3.563	2.76	19.9
	<b>11438-23</b>	0.531	3.406	2.656	4.406	2.76	35.9
	<b>11438-24</b>	0.875	3.719	3.938	4.750	2.76	61
	<b>11438-25</b>	0.875	3.719	3.938	4.750	2.76	34.4
	<b>11438-30</b>	1.125	2.750	1.563	3.750	2.76	21.3
	<b>11438-31</b>	1.063	3.156	3.094	5.625	2.76	25.3
	<b>11438-32</b>	1.500	3.750	1.375	4.375	2.76	12.4

Based on the largest/heaviest version of each type.

## BALL VALVES

- 2-way versions provide on-off control with a simple quarter turn of the handle
- 3-way versions divert flow to either outlet; no shut-off
- Inlet connections range from 3/8" to 1-1/2" (NPT or BSPT)
- Maximum pressure up to 300 psi (20 bar)
- Constructed of nylon glass-reinforced polypropylene



**AA(B)344M-PP  
Ball Valve**

## SPECIFICATIONS

Valve Number	Maximum Pressure (psi)	Number of Outlets	Connection Size (in.)	Materials of Wetted Parts
AA(B)344M-2-3/4	300	1	3/4	Nylon, PTFE, polypropylene and Viton®
AA(B)344M-2-1			1	
AA(B)343M-2-3/8-PP	150	1	3/8	Glass-reinforced polypropylene, PTFE and Viton
AA(B)343M-2-1/2-PP			1/2	
AA(B)344M-2-3/4-PP	125	1	3/4	
AA(B)344M-2-1-PP			1	
AA(B)346M-2-1-1/4-PP			1-1/4	
AA(B)346M-2-1-1/2-PP			1-1/2	
AA(B)344M-3-3/4	300	2	3/4	Nylon, PTFE, polypropylene and Viton
AA(B)344M-3-1			1	
AA(B)343M-3-3/8-PP	150	2	3/8	Glass-reinforced polypropylene, PTFE and Viton
AA(B)343M-3-1/2-PP			1/2	
AA(B)344M-3-3/4-PP	125	2	3/4	
AA(B)344M-3-1-PP			1	
AA(B)346M-3-1-1/4-PP			1-1/4	
AA(B)346M-3-1-1/2-PP			1-1/2	

## ORDERING INFORMATION

Valve No.	EXAMPLE	<b>AA344M-2-3/4</b>
-----------	---------	---------------------



**PLUG VALVES**

- Easy in-line shut-off
- Manual operation
- Ball valve provides more robust operation than plug valves
- Max. pressure: 400 psi (27 bar)

**VALVE OPTIONS**

**23220 Plug Valve, Female x Female**

- Available in:
  - 1/8" female inlet and 1/8" female outlet conn.
  - 1/4" female inlet and 1/8" female outlet conn.
  - 1/4" female inlet and 1/4" female outlet conn.



- Materials: Brass body with Celcon® plug handle

**23220 Plug Valve, Female x Male**

- 1/4" female inlet and 1/4" male outlet conn.
- Materials: Brass body with Celcon plug handle



**23220 Plug Valve, Male x Female**

- 1/4" male inlet and 1/4" female outlet conn.
- Materials: Brass body with Celcon plug handle



**ORDERING INFORMATION**



EXAMPLE



BSPT connections require the addition of "B" prior to the inlet connection.

**DIMENSIONS AND WEIGHTS**

Valve	Accessory Type	Inlet Conn. (in.)	Outlet Conn. (in.)	L (in.)	H (in.)	Net Weight (oz.)
	23220	1/4 (F)	1/8 (F)	1-3/4	1-5/32	2.08
		1/4 (F)	1/4 (F)	1-3/4	1-5/32	2.08
		1/8 (F)	1/8 (F)	1-3/4	1-5/32	2.43
	23220	1/4 (M)	1/4 (F)	1-3/4	1-5/32	2.08
	23220	1/4 (F)	1/4 (M)	1-3/4	1-5/32	1.98

Based on the largest/heaviest version of each type.



**EXTENSIONS**

Are available to help position the spray tip or set-up precisely where it needs to be.

**EXTENSION OPTIONS**

**17180**

- 3", 6", 9", 12" pipe sizes
- For use with 1/8JJ Series nozzles
- Materials: Brass or 303 stainless steel (SS)



**18096**

- 3", 6", 9", 12" pipe sizes
- For use with 1/4J Series nozzles
- Materials: Brass or 303 stainless steel (SS)



**17185**

- 3", 6", 9", 12" pipe sizes
- For use with 1/8JJAU Series automatic nozzles
- Materials: Brass or 303 stainless steel (SS)



**6123**

- 3", 6", 9", 12" pipe sizes
- For use with 1/4JAU Series automatic nozzles
- Materials: Brass or 303 stainless steel (SS)



**ORDERING INFORMATION**

**EXTENSIONS 17180, 18096, 17185**

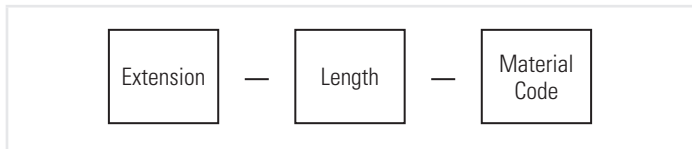

EXAMPLE



There is no material code for brass. Leave material code blank when ordering.

**EXTENSION 6123**

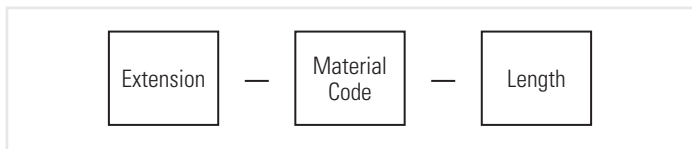

EXAMPLE



There is no material code for brass. Leave material code blank when ordering.



**SPLIT-EYELET CONNECTORS**

Split-eyelet connectors provide a quick and easy way to connect spray nozzles to piping systems

- Simply drill a hole in side of pipe
- Place inlet of split eyelet into the hole; seal eliminates leaking
- Assemble the clamp component to secure the assembly to the pipe

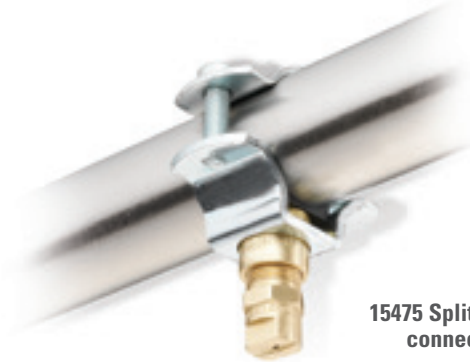

**15475 Split-eyelet connector**

**CONNECTOR OPTIONS**

**8370**

- 1-1/4", 1-1/2", 2" pipe size
- 1/8", 1/4", 3/8", 1/2" female outlet connection
- Materials: Zinc-plated steel clamps/bolts with brass body (A), all stainless steel (B) or zinc-plated steel clamps/bolts with stainless connector body (C)



**15475**

- 2-1/2", 3", 4" pipe size
- 1/4", 3/8", 1/2", 3/4", 1" female outlet connection
- Materials: Zinc-plated steel clamps/bolts with brass body (A), all stainless steel (B) or zinc-plated steel clamps/bolts with stainless connector body (C)



**38180 Split Eyelet Swivel Union**

- 1/2", 3/4", 1" pipe sizes
- 1/4" male outlet connection
- Swivel union allows easier product positioning
- Materials: Brass or 303 stainless steel (SS)



**ORDERING INFORMATION**

**CONNECTORS 15475 AND 8370**

Split-Eyelet Connector Type	Material Code	—	Pipe Size	×	Outlet Conn.
-----------------------------	---------------	---	-----------	---	--------------

EXAMPLE

8370	A	—	1-1/4	×	1/4
------	---	---	-------	---	-----

**SWIVEL CONNECTOR 38180**

Split-Eyelet Swivel Union	—	Pipe Size	—	Material Code
---------------------------	---	-----------	---	---------------

EXAMPLE

38180	—	1/2	—	SS
-------	---	-----	---	----

\*There is no material code for brass 38180 connectors. Leave material code blank when ordering.

**SPECIFICATIONS**

Split-Eyelet	To Clamp On		Outlet Conn. (F) (in.)					Maximum Pressure psi	Capacity at Maximum Pressure gpm	Material Code	
	Pipe Size (in.)	Outside Dia. Tubing (in.)	1/8	1/4	3/8	1/2	3/4				1
8370	1-1/4	1-9/16, 1-11/16	•	•	•	•			125	5.5-20*	A, B, C
	1-1/2	1-3/4, 2	•	•	•	•					
	2	2-1/8, 2-3/8	•	•	•	•					
15475	2-1/2	2-1/2, 2-7/8		•	•	•	•	•	125	10-54*	A, B, C
	3	3, 3-1/2		•	•	•	•	•			
	4	4, 4-1/2		•	•	•	•	•			

Capacities of 8370 and 15475 Vary with Outlet Conn.	
Outlet Conn. (in.)	Capacity gpm
1/8	5.5
1/4	10
3/8	15
1/2	20
3/4	33
1	54

\*Capacities of 8370 and 15475 vary with outlet connection.

Split-Eyelet	To Clamp On		Maximum Pressure psi	Materials
	Pipe Size (in.)	Outside Dia. Tubing (in.)		
38180	1/2	13/16, 7/8	250	Nickel-plated brass with zinc-plated pipe clamps, 303 stainless steel (SS)
	3/4	1, 1-1/6		
	1	1-1/8, 1-1/4, 1-3/8		

**DIMENSIONS AND WEIGHTS**

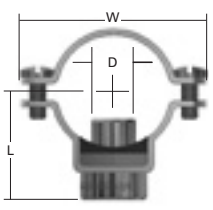
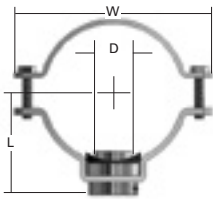
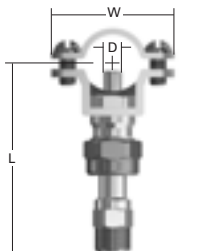
Split-Eyelet	Accessory Type	Pipe Size (in.)	W (in.)	D (Dia.) (in.)	L (in.)	Net Weight (oz.)
	<b>8370</b>	1-1/4	2.75	0.688	1.611	6.3
		1-1/2	3.19	0.688	1.731	7
		2	3.47	0.688	1.970	7.4
	<b>15475</b>	2-1/2	4.656	1.250	2.469	9.8
		3	5.375	1.250	2.781	28.9
		4	6.438	1.250	3.281	34.2
	<b>38180</b>	1/2	1-7/8	0.281	3.509	3.7
		3/4	2-1/8			
		1	2-1/4			

Based on the largest/heaviest version of each type.

**MOUNTING KITS**

**28945-001-316SS**

- Clamp mounting kit.
- Mounting bolt has 3/8-24 UNF thread for VAA, VAU and VMAU nozzles



**28945-002-SS**

- Mounting kit for 1/2" rod
- Mounting bolt has 3/8-24 UNF thread for VAA, VAU and VMAU nozzles



**28945-003-316SS**

- Mounting kit for 1/2" rod
- Mounting bolt has 1/8" NPT thread for JAU nozzle series



**ORDERING INFORMATION**

Mounting Kit Number

EXAMPLE

**28945-001-316SS**

**2335-SE SPRAY PIPE ASSEMBLY**

- 1/4" globe valve
- 1/4" piping (1-1/2" and 8" lengths)
- 1/4" copper tubing
- Union nut and connectors (2)
- Materials of construction: galvanized iron, brass (material code - B)



**2335-SE Spray Pipe Assembly**

**ORDERING INFORMATION**

Spray Pipe Assembly

—

Material Code

EXAMPLE

**2335-SE**

—

**B**

There is no material code for galvanized iron. Leave material code blank when ordering.

**2202 PIPE HANGER**

- Used for proper spacing between air and liquid lines. Sizes fit 1/2" piping
- Hanger is held by threaded rod and nuts (not included) for vertical adjustment
- Made of cast aluminum. 4" (10 cm) spacing
- Use with 2335-SE spray pipe assembly



2202 Pipe Hanger

**ORDERING INFORMATION**

Pipe Hanger	EXAMPLE
	2202-AL

**WALL MOUNT ADAPTERS**

**1/8J and 1/4J Nozzles**

- For thick walls adapter CP3376
- For thin walls adapter CP3376, gasket CP2804-3 and locknut CP6378
- Materials of construction:
  - Adapter and locknut, nickel-plated brass (NP), 303 stainless steel (SS) or 316 stainless steel (316SS)
  - Gasket, Buna-N (BU) or PTFE (TEF)

**1/2J Nozzles**

- For thick walls adapter CP4886

**VAA, VAU, VMAU Nozzles**

- Thick Wall Adapter - CP31158-003-SS
- Thin Wall Adapter - CP31158-002-SS



CP31158-003-SS



CP31158-002-SS

**ORDERING INFORMATION**

**ADAPTER FOR 1/8J AND 1/4J NOZZLES**

Adapter, Gasket or Locknut Number	—	Material Code	EXAMPLE
			CP3376 — SS

**ADAPTER FOR VAA, VAU, VMAU NOZZLES**

Wall Mount Adapter Number	EXAMPLE
	CP31158-003-SS



**22140 PRESSURE TANK ASSEMBLY**

- 22140 Pressure Tank Assembly
- Meets ASME® Boiler and Pressure Vessel Code requirements and OSHA safety regulations
- Constructed of 304 stainless steel (SS)
- Assembly includes a pressure regulator with gauge, ASME coded pressure relief valve, air bleed valve and plug valves for air inlet and liquid outlet
- Tanks are available in 1, 2, 5, 10 and 16 gallon (3.8, 7.6, 18.9, 38 and 61 liter) capacities
- The air inlet and liquid outlet have 1/4" NPT (F) connections
- The maximum working pressure is 140 psi at 100°F (9.5 bar at 38°C)
- The 22140 features brass fittings and an EPR lid seal



22140 Pressure Tank Assembly

**ORDERING INFORMATION**

Pressure Tank	—	Capacity Size (in gallons)	—	Material Code	EXAMPLE	22140	—	5	—	304SS
---------------	---	----------------------------	---	---------------	---------	-------	---	---	---	-------

**FLOAT BOX AND VALVE**

**45600 Float Box**

Stainless float box with a polypropylene float valve and float ball



**45604 Float Valve**

Brass float valve and polypropylene float ball



**ORDERING INFORMATION**

Float Box or Float Valve Number	EXAMPLE	45600
---------------------------------	---------	-------

**39273 AND 39275 LEVEL SWITCHES**

- Indicates a low liquid level condition inside the pressure tank
- Use with pressure tank assemblies with external 1/4" NPT (F) threads
- Features a U.L. listed float switch, quick disconnect and 12' (3.6 m) PVC jacketed cable
- Available in brass with Buna-N float or all stainless steel

**39275 Level Switch****SPECIFICATIONS**

Level Switch Part Number	Matching Tank Size	Minimum Specific Gravity	Materials	
			Tube & Fittings	Float
39275-1	1 gal (3.8 liter)	0.65	Brass	Buna-N
39275-1-SS		0.7	Stainless Steel	316 stainless steel
39275-2	2 gallon (7.6 liter)	0.65	Brass	Buna-N
39275-2-SS		0.7	Stainless Steel	316 stainless steel
39273	5, 10 gallon (18.9, 38 liter)	0.65	Brass	Buna-N
39273-SS		0.7	Stainless Steel	316 stainless steel
39273-1	16 gallon (61 liter)	0.65	Brass	Buna-N
39273-1-SS		0.7	Stainless Steel	316 stainless steel

**ORDERING INFORMATION**

<div style="border: 1px solid black; padding: 5px; display: inline-block;">           Level Switch Part Number         </div>	EXAMPLE <div style="border: 1px dashed black; padding: 5px; display: inline-block; margin-top: 10px;"> <b>39275-1-SS</b> </div>
---	--



**50580 ADJUSTABLE SIPHON INJECTORS**

- Provide a convenient method for adding chemicals to liquid flow before spraying
- Siphon rate is controlled with a metering screw
- Max pressure – 3000 psi (207 bar)
- Capacity sizes available up to 6.0 gpm (22.7 lpm)
- Liquid inlet and outlet connections 3/8" or 1/2" NPT or BSPT
- Standard hose barb connection injection inlet; optional 1/4" NPT or BSPT
- Materials: Brass or 303 stainless steel (SS)

**50580 Adjustable Siphon Injector****SPECIFICATIONS**

Model Number	Inlet & Outlet Thread Connection Size	Matching Capacity	Siphon Thread Connection Size
50580	3/8 or 1/2	05 (0.5 gpm ; 1.9 lpm)	1/4
		10 (1.0 gpm; 3.8 lpm)	
		15 (1.5 gpm; 5.7 lpm)	
		20 (2.0 gpm; 7.6 lpm)	
		30 (3.0 gpm; 11.4 lpm)	
		40 (4.0 gpm; 15.1 lpm)	
		50 (5.0 gpm; 18.9 lpm)	
		60 (6.0 gpm; 22.7 lpm)	

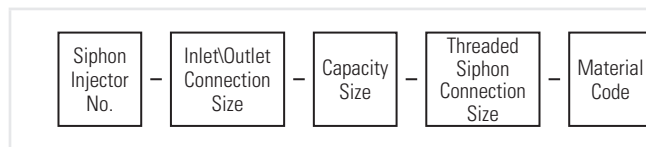
**ORDERING INFORMATION**

There is no material code for brass. Leave material code blank when ordering.  
Leave threaded siphon connection size blank for hose barb connection siphon inlet.

**EXAMPLE**

BSPT connections require the addition of a "B" prior to the model number.

**PLACING YOUR ORDER**

**Call 1.800.95.SPRAY for application assistance  
or to place an order.**

**SPRAYING SYSTEMS CO.'S  
TRADEMARK USAGE**

The following is a current list of Spraying Systems Co.'s trademarks registered in the United States. Some marks are registered in other countries as well.

AccuCoat®	QuickMist®
AirJet®	SpiralJet®
AutoJet®	SprayDry®
FloMax®	TankJet®
FullJet®	UniJet®
GunJet®	VeeJet®
MiniFogger®	WhirlJet®
PanelSpray®	WindJet®
PulsaJet®	

**REGISTERED TRADEMARK CREDITS**

The following trademarks are registered to other entities in the US and may be registered in other countries as well.

AMPCO®	Kynar®
ANSI®	Lucite®
ASME®	Monel®
ASTM®	NEMA®
Carpenter®	Peek™
Celcon®	Refrax®
Cupro®	Ryton®
Hastelloy®	Stellite®
Inconel®	Viton®
Kel-F®	

Spraying Systems Co. reserves the right to make changes in specifications or design of the products shown in the catalog or to add improvements at anytime without notice or obligation.

**HOW TO ORDER**

For your convenience, there are multiple ways to place an order: phone, fax and online

**In North America**

Phone: 1.800.95.SPRAY | Fax: 1.888.95.SPRAY

**Outside North America**

Phone: 1.630.665.5000 | Fax: 1.630.260.0842

Online ordering is also available. Visit [spray.com/sprayfinder](https://spray.com/sprayfinder). You'll find helpful selection tools, detailed product specs and 3D CAD models for our full product line and live chat for immediate assistance.



**(1) MODIFICATION OF TERMS**

Seller's acceptance of any order is expressly subject to Buyer's assent to each and all of the terms and conditions set forth below and Buyer's assent to these terms and conditions shall be conclusively presumed from Buyer's receipt of this document without prompt written objection thereto or from Buyer's acceptance of all or any part of goods ordered. No addition to or modification of said terms and conditions shall be binding upon Seller unless specifically agreed to by Seller in writing. If Buyer's purchase order or other correspondence contains terms or conditions contrary to or in addition to the terms and conditions set forth below, acceptance of any order by Seller shall not be construed as assent to such contrary or additional terms and conditions or constitute a waiver by Seller of any of the terms and conditions.

**(2) PRICE**

Unless otherwise specified: (a) all prices, quotations, shipments and deliveries by Seller are (i) EXW (Incoterms® 2010) if shipped to the Buyer within the United States, and (2) in all other circumstances DAP Buyer's location (Incoterms® 2010); (b) all base prices together with related extras and deductions, are subject to Seller's price in effect at the time of shipment; and (c) notwithstanding the use of the shipping term DAP and without any effect on the point at which the risk of loss shifts from Seller to Buyer, all transportation, import costs and other related charges are for the account of Buyer, including all increases or decreases in such charges prior to shipment. Payment of said price shall be due at the remittance address shown on the Seller's invoice upon receipt of Seller's invoice unless otherwise specified. Interest will be charged at a rate of 1 to 1-1/2% per month on all balances outstanding more than 30 days after the date of the invoice. Price includes Seller's standard packaging. Special packaging requirements shall be quoted at an additional price.

**(3) UNIFORM COMMERCIAL CODE**

THIS IS A CONTRACT FOR THE SALE OF GOODS. SELLER AND BUYER EXPRESSLY AGREE THAT ANY SERVICES PROVIDED PURSUANT TO THIS CONTRACT ARE MERELY INCIDENTAL TO THE SALE OF GOODS, AND AS SUCH, SHALL BE DEEMED GOODS UNDER ARTICLE 2 OF THE UNIFORM COMMERCIAL CODE. SELLER AND BUYER FURTHER AGREE THAT ANY DISPUTES ARISING FROM THIS CONTRACT SHALL BE GOVERNED BY ARTICLE 2 OF THE UNIFORM COMMERCIAL CODE.

**(4) MINIMUM BILLING**

Contact your regional office representative for any minimum order requirements.

**(5) WARRANTIES**

Seller warrants that its products will conform to and perform in accordance with the products' specifications. Seller warrants that the products do not infringe upon any copyright, patent, or trademark. THE FOREGOING WARRANTIES ARE IN LIEU OF ALL OTHER WARRANTIES, EXPRESSED OR IMPLIED, INCLUDING, BUT NOT LIMITED TO, THOSE CONCERNING MERCHANTABILITY AND FITNESS FOR A PARTICULAR PURPOSE.

**(6) LIMITATION OF REMEDIES**

Buyer's remedies under this warranty shall be limited to the replacement, repair, or refund of the purchase price for any defective product at the Seller's option. Products claimed to be defective and for which repair or replacement is desired shall be, if requested by the Seller, returned transportation prepaid to Seller's plant for inspection. Results of ordinary wear and tear, improper operation, or maintenance or use of corrosive or abrasive materials shall not be considered a defect in material or workmanship. Any component part manufactured by another is not covered by Seller's warranty, but only by such warranty as its manufacturer gives. Because of the difficulty of asserting and measuring damages hereunder, it is agreed that, except for claims for bodily injury, Seller's liability to the Buyer or any third party, for any losses or damages, whether direct or otherwise, arising out of the purchase of product from Seller by Buyer shall not exceed the total amount billed and billable to the Buyer for the product hereunder. IN NO EVENT WILL SELLER BE LIABLE FOR ANY LOSS OF PROFITS OR OTHER SPECIAL OR CONSEQUENTIAL DAMAGES, EVEN IF SELLER HAS BEEN ADVISED OF THE POSSIBILITY OF SUCH DAMAGES.

**(7) QUALITY ASSURANCE**

Seller shall have no obligation to ensure that any goods purchased from Seller meet any special Buyer quality assurance specifications and/or other special Buyer requirements unless such specifications and/or other requirements are specifically set forth in Buyer's purchase order and expressly accepted by Seller. In the event that any such goods supplied by Seller in connection therewith, are applied to an end use without the appropriate specification and/or other requirement therefore having been set forth in Buyer's purchase order and expressly accepted by Seller, Buyer shall indemnify and hold Seller harmless against any and all damages or claims for damages made by any person for any injury, fatal or nonfatal, to any person or for any damage to the property of any person incident to or arising out of such application.

**(8) PRODUCT DISPOSAL & SUSTAINABILITY**

Buyer is responsible for the disposal of goods supplied by seller in accordance with all applicable laws, regulations, and responsible recycling and/or sustainability practices.

**(9) CLAIMS**

Claims respecting the condition of goods, compliance with specifications or any other matter affecting goods shipped to Buyer must be made promptly and, unless otherwise agreed to in writing by Seller, in no event later than one (1) year after receipt of the goods by Buyer. In no event shall any goods be returned, reworked or scrapped by Buyer without the express written authorization of Seller.

**(10) DEFAULT IN PAYMENT**

If Buyer fails to make payments on any contract between Buyer and Seller in accordance with Seller's terms, Seller, in addition to any other remedies available to it, may at its option, (i) defer further shipments until such payments are made and satisfactory credit arrangements are reestablished or (ii) cancel the unshipped balance of any order.

**(11) TECHNICAL ASSISTANCE**

Unless otherwise expressly stated by Seller, (a) any technical advice provided by Seller with respect to the use of goods furnished to Buyer shall be without charge; (b) Buyer shall have sole responsibility for selection and specification of the goods appropriate for the end use of such goods.

**(12) SAFETY PRECAUTIONS**

Buyer shall require its employees to use all safety devices, and proper safe operation procedures as set forth in manuals and instruction sheets furnished by Seller. Buyer shall not remove or modify any such device or warning sign. It is the Buyer's responsibility to provide all means that may be necessary to effectively protect all employees from serious bodily injury which otherwise may result from the method of particular use, operation, set up or service of the goods. The operator's or machine manual, ANSI safety standards, OSHA regulations and other sources should be consulted. If Buyer fails to comply with provisions of this paragraph or the applicable standards and regulations aforementioned, and a person is injured as a result thereof, Buyer agrees to indemnify and save Seller harmless from any liability or obligation incurred by Seller.

**(13) CANCELLATION**

Orders for goods specifically manufactured for Buyer cannot be canceled or modified by Buyer, and releases cannot be held up by Buyer, after such goods are in process except with the express written consent of Seller and subject to conditions then to be agreed upon which shall include, without limitation, protection of Seller against all loss.

**(14) PATENTS**

The Seller shall not be liable for any costs or damages incurred by the Buyer as a result of any suit or proceeding brought against Buyer so far as based on claims (a) that use of any product, or any part thereof furnished hereunder, in combination with products not supplied by the Seller or (b) that a manufacturing or other process utilizing any product, or any part thereof furnished hereunder, constitute knowing and willful infringement of patents or trademarks arising from compliance with Buyer's designs or specifications or instructions.

**(15) COMPLETE AGREEMENT**

THIS CONTRACT SETS FORTH THE ENTIRE AGREEMENT AND UNDERSTANDING OF THE PARTIES RELATING TO THE SUBJECT MATTER HEREOF, AND SUPERSEDES ALL PRIOR AGREEMENTS, DISCUSSIONS AND UNDERSTANDINGS BETWEEN THEM WHETHER ORAL OR WRITTEN, RELATING TO THE SUBJECT MATTER HEREOF.

**(16) GOVERNING LAW**

All orders are accepted by Seller at its mailing address in Wheaton, Illinois, and shall be governed by and interpreted in accordance with the laws of the State of Illinois. The United Nations Convention on Contracts for the International Sale of Goods of April 11, 1980 shall be excluded.

**(17) FORCE MAJEURE**

Neither party shall be in default of its obligations to the other party for any period of Force Majeure. "Force Majeure" shall mean any delay or failure of a party to perform its obligations to the other party due to causes beyond its control and without its fault or negligence. This shall include, without limitation, Acts of God, strike, civil commotion, acts of government, and any other comparable, non-foreseeable, and a serious event.

**(18) CONFIDENTIAL INFORMATION**

Buyer shall maintain Confidential Information in confidence using the same care as used for its own Confidential Information. Buyer shall not disclose or divulge any Confidential Information received by it from Seller in connection with any products or services supplied by Seller to Buyer or to a third party without prior written consent of Seller, and Buyer may not use any Confidential Information for any purpose other than for the manufacture, sale and maintenance of Buyer's products. For the purposes hereof, "Confidential Information" includes any and all information and data, including, but not limited to, any business, commercial, intellectual property, technical information and data disclosed by Seller to Buyer in connection with the sale of Seller's products to Buyer, or relating to Seller's business relationship or the definition, development, marketing, selling, manufacture or distribution of Seller's products, whether disclosed orally, in writing or electronically, and irrespective of the medium in which such information or data is embedded, whether in tangible form or contained in an intangible storage medium. Confidential Information shall include any copies or abstracts made thereof, as well as any product, apparatus, modules, samples, prototypes or parts thereof.

**(19) FAIR PRACTICES**

Spraying Systems Co. considers for employment and hire qualified candidates without regard to race, religion, color, sex, sexual orientation, gender, gender identity, age, national origin, ancestry, citizenship, protected veteran or disability status or any factor prohibited by law, and as such affirms in policy and practice to support and promote the concept of equal employment opportunity and affirmative action, in accordance with all applicable federal, state, provincial and municipal laws.



## ACCESSORIES

### Air Line Filters

11438 Air Line Filter . . . . . G9

### Ball Valve

AA(B)343M-PP . . . . . G16

AA(B)344M-PP . . . . . G16

AA(B)346M-PP . . . . . G16

### Extensions

17180 . . . . . G18

17185 . . . . . G18

18096 . . . . . G18

6123 . . . . . G18

### Liquid & Air Pressure Regulators

11438 Air Pressure Regulator . . . . . G12

11438 Liquid Pressure Regulator . . . . . G12

### Liquid Pressure Gauges

26383 Liquid Pressure Gauge . . . . . G11

26385 Liquid Pressure Gauge . . . . . G11

### Liquid Strainers

16106 . . . . . G4

9830 . . . . . G4

AA122 . . . . . G4

AA124/AA430 . . . . . G5

TWD . . . . . G4

### Mounting Kits

28945-001-316SS . . . . . G21

28945-002-SS . . . . . G21

28945-003-316SS . . . . . G21

### Other Accessories

22140 Pressure Tank Assembly . . . . . G23

39273 Level Switches . . . . . G24

39275 Level Switches . . . . . G24

50580 Adjustable Siphon Injectors . . . . . G25

### Pipe Assembly

2335-SE Spray Pipe Assembly . . . . . G21

### Pipe Hanger

2202 Pipe Hanger . . . . . G22

### Plug Valves

23220 Plug Valves . . . . . G17

### Solenoid Valves

2-Way Solenoid Valve . . . . . G14

3-Way Solenoid Valve . . . . . G14

### Split-Eyelet Connectors

15475 Split-Eyelet Connector . . . . . G19

38180 Split-Eyelet Swivel Union . . . . . G19

8370 Split-Eyelet Connector . . . . . G19

### Wall Mount Adapters

CP31158-002-SS . . . . . G22

CP31158-003-SS . . . . . G22

Wall mount adapters for 1/8J and 1/4J nozzles . . . . . G22

Wall mount adapters for VAA, VAU, VMAU Nozzles . . . . . G22

## AIR ATOMIZING NOZZLES

### High Efficiency, High Flow Spray Nozzle Series

FloMax® A Series . . . . . C14

FloMax X Series . . . . . C14

### J and JJ Series

1/8JAC . . . . . C7

1/8JJ Series . . . . . C5, C8

1/8JCO . . . . . C8

1/8JJN . . . . . C8

1/4J Series . . . . . C5, C6

1/4JAC . . . . . C7

1/4JACN . . . . . C7

1/4JBC . . . . . C7

1/4JBCJ . . . . . C7

1/4JCO . . . . . C7

1/4JN . . . . . C7

1/2-2J . . . . . C9

1/2J Series . . . . . C5, C9

1/2JBC . . . . . C9

1/2JBCJ . . . . . C9

1/2JCO . . . . . C9

1/2JN . . . . . C9

1J Series . . . . . C5, C10

1JN . . . . . C10

11005-1/4J . . . . . C7

6552-1/8JAC . . . . . C7

8650 . . . . . C7

### QuickMist® Series Nozzles

1/4QMJ and 1/4QMJML . . . . . C11

### Variable Spray Nozzle Series

1/8VAA Series . . . . . C12, C13

1/8VAACO . . . . . C13

1/8VAAN . . . . . C13

1/8VAANCO . . . . . C13

## AUTOMATIC NOZZLES

### Air-Actuated Air Atomizing Nozzles

1/8JJAU Series . . . . . B15, B17

1/8JJAU . . . . . B15, B17

1/8JJAU MCO . . . . . B17

1/8VAU . . . . . B15

1/4VMAU . . . . . B15

10535-1/4J . . . . . B15, B18

10536-1/2J . . . . . B15, B18

14675-1/8JJAU . . . . . B17

14700-1/8JJAU . . . . . B17

16860-1/8JJAU . . . . . B17

16883-1/8JJAU . . . . . B17

17690-1/8JJAU . . . . . B17

19330-1/4JAUPM . . . . . B16

38499-1/8JJAU . . . . . B17

49660-1/8JJAU . . . . . B17

72100-1/8JJAU . . . . . B15, B18

D55500-JAU . . . . . B15, B18

D55500-JAU CO . . . . . B15, B18

JAU A . . . . . B15, B16

JAUACO . . . . . B16

JAUAD . . . . . B16

JAUADN . . . . . B16

JAUAMCO . . . . . B16

JAUAPM . . . . . B16

JAUAPMCO . . . . . B16



VAU/VMAU Variable Spray . . . . . B15, B18  
 VX Variable Spray . . . . . B15, B18

**Air-Actuated Hydraulic Nozzles**

1/4JUAUH . . . . . B12, B13  
 1/8JUAUH . . . . . B12, B13  
 AA22AUH . . . . . B12, B13  
 AA22AUH-7676 . . . . . B12, B13  
 AA22AUH-SS-11024 . . . . . B12, B14  
 AA22AUH-SS-14799 . . . . . B12, B14  
 AA24AUA . . . . . B12, B14  
 AA24AUA-20190 . . . . . B12, B14  
 AA24AUA-8395 . . . . . B12, B14  
 AA24AUA-8980 . . . . . B12, B14  
 D55500-JAUH1 . . . . . B12, B13  
 D55500-JAUHO . . . . . B12, B13

**Electrically-Actuated Air Atomizing Nozzles**

AA10000JAU-10 . . . . . B10, B11  
 AA10000JJAU . . . . . B10, B11  
 AA28JJAU-49815 . . . . . B10, B11  
 AA29JAUCO . . . . . B10, B11

**Electrically-Actuated Hydraulic Nozzles**

AA10000AUH-0050 . . . . . B7, B8  
 AA10000AUH-03 . . . . . B7  
 AA10000AUH-03-Z1 . . . . . B7  
 AA10000AUH-10 . . . . . B7, B8  
 AA10000AUH-104210 . . . . . B7, B8  
 AA10000AUH-104214 . . . . . B7, B8  
 AA10000AUH-104215 . . . . . B7, B8  
 AA10000AUH-72440-1/4 . . . . . B7, B8  
 AA250AUH . . . . . B9  
 AA26AUH . . . . . B9  
 AA26AUH-24200-2-1/2 . . . . . B9

**FOGGING & HUMIDIFICATION**

**AirJet® Fogger Nozzles**

23412 AirJet Fogger . . . . . E4, E6  
 QJ25655 AirJet Fogger . . . . . E4, E6

**DripSafe™ AirJet Fogger Nozzles**

45265 AirJet Fogger . . . . . E4, E5  
 45269 AirJet Fogger . . . . . E4, E5

**YMF MiniFogger® III**

Spray Set-ups . . . . . E4, E7

**SPRAY MANIFOLDS**

53500 Modular Manifold . . . . . F4, F5  
 54000 Modular Manifold . . . . . F4, F5  
 63600 Sanitary Manifold . . . . . F4, F6  
 98250 Manifold . . . . . F4, F6

**SPRAY PERFORMANCE DATA**

**Air Atomizing Set-Up Compatibility**

Compatibility Charts . . . . . D72

**Air Atomizing Spray Set-ups for 1/4J, 1/4JAU, PulsaJet (JAU), AA29JAUCO, 10535 & D55500-JAU Series Nozzles**

Pressure Spray Set-ups  
 External Mix - Flat Tips . . . . . D22, D30  
 Internal Mix - 360° Circular Tips . . . . . D22, D27  
 Internal Mix - Deflected Flat Tips . . . . . D22, D29  
 Internal Mix - Flat Tips . . . . . D22, D28  
 Internal Mix - Round Tips . . . . . D22, D24  
 Internal Mix - Wide Angle Round Tips . . . . . D22, D26  
 Siphon/Gravity Spray Set-ups  
 External Mix - Flat Tips . . . . . D22, D32  
 External Mix - Round Tips . . . . . D22, D33  
 External Mix - Wide Angle Round Tips . . . . . D22, D34

**Air Atomizing Spray Set-ups for 1/8JJ, 1/8JJAU, PulsaJet® (JJAU) & AA28JJAU Series Nozzles**

Pressure Spray Set-ups  
 External Mix - Flat Tips . . . . . D22, D39  
 Internal Mix - 360° Circular Tips . . . . . D22, D36  
 Internal Mix - Flat Tips . . . . . D22, D38  
 Internal Mix - Round Tips . . . . . D22, D35  
 Internal Mix - Wide Angle Round Tips . . . . . D22, D37  
 Siphon/Gravity Spray Set-ups  
 External Mix - Flat Tips . . . . . D22, D42  
 External Mix - Round Tips . . . . . D22, D41

**Air Atomizing Spray Set-ups for 1/2J & 10536 Series Nozzles**

Pressure Spray Set-ups  
 External Mix - Flat Tips . . . . . D22, D46  
 External Mix - Round Tips . . . . . D22, D48  
 Internal Mix - Flat Tips . . . . . D22, D43  
 Internal Mix - Round Tips . . . . . D22, D45  
 Internal Mix - Wide Angle Round Tips . . . . . D22, D44

**Air Atomizing Spray Set-ups for 1J & 10537 Series Nozzles**

Pressure Spray Set-Ups  
 External Mix - Flat Tips . . . . . D22, D52  
 External Mix - Round Tips . . . . . D22, D52  
 Internal Mix - Flat Tips . . . . . D22, D51  
 Internal Mix - Round Tips . . . . . D22, D50  
 Internal Mix - Wide Angle Round Tips . . . . . D22, D49  
 Siphon/Gravity Spray Set-ups  
 External Mix - Round Tips . . . . . D22, D53

**Air Atomizing Spray Set-ups for QuickMist® Spray Series Nozzles**

Pressure Spray Set-ups  
 Internal - Flat Tips . . . . . D22, D56  
 Internal - Round Tips . . . . . D22, D54  
 Internal - Wide Angle Round Tips . . . . . D22, D55  
 Siphon/Gravity Spray Set-ups  
 Internal Mix - Flat Tips . . . . . D22, D58  
 Internal Mix - Round Tips . . . . . D22, D57

**Air Atomizing Spray Set-ups for VAU & VAA Variable Spray Series Nozzles**

Pressure Spray Set-ups  
 External Mix - Variable Tips . . . . . D22, D62

**Air Atomizing Spray Set-ups for VMAU Variable Spray Series Nozzles**

Pressure Spray Set-ups  
 External Mix - Variable Tips . . . . . D22, D59

**Air Atomizing Spray Set-ups for VX Variable Spray Series Nozzles**

External Mix - Flat Tips . . . . . D22, D64

**Numbering System for Air Caps and Fluid Caps**

Air Caps Pressure Set-Ups (Internal Mix) . . . . D70  
 Fluid Cap For use with all Set-ups . . . . . D71  
 Pressure Set-ups (External Mix) . . . . . D71  
 Siphon/Gravity Feed Set-Ups (External Mix) . . . . . D71

**UniJet TPU Hydraulic Spray Tips for JAUH, JJAUH, AA22AUH, AA24AUA, AA26AUH, D55500-JAUH nozzles**

UniJet TG Hydraulic Full Cone Tips . . . . . D4, D18  
 UniJet TG-W Hydraulic Full Cone Tips . . . . . D4, D18  
 UniJet TN Hydraulic Hollow Cone Tips . . . . . D4, D20  
 UniJet TN-SSTC Hydraulic Hollow Cone Tips . . . . . D4, D21  
 UniJet TP-TC Hydraulic Flat Tips . . . . . D4, D14  
 UniJet TX Hydraulic Hollow Cone Tips . . . . . D4, D19

**UniJet TPU Hydraulic Spray Tips for PulsaJet 104210, 104214, 104215**

UniJet PWMD Premium Hydraulic Flat Spray tips . . . . . D4, D12

**UniJet TPU Hydraulic Spray Tips for PulsaJet 0050 nozzles**

UniJet PWMM Premium Hydraulic Flat Spray tips . . . . . D4, D12

**UniJet TPU Hydraulic Spray Tips for PulsaJet® Series\*, JAUH, JJAUH, AA22AUH, AA24AUA, AA26AUH, D55500-JAUH Series** (except for 104210, 104214, 104215 and 0050)

UniJet TPU Hydraulic Flat Tips . . . . . D4, D6

**PART NUMBER – NUMERICAL**

**1**

1/8-2JAC . . . . . C7  
 1/8J Series . . . . . C5, C6  
 1/8J . . . . . C5, C6  
 1/8JAC . . . . . C7  
 1/8JACN . . . . . C7  
 1/8JBC . . . . . C7  
 1/8JCO . . . . . C7  
 1/8JJ Series . . . . . C5, C8  
 1/8JJAU Series . . . . . B15, B17  
 1/8JJAUH . . . . . B12, B13  
 1/8JJAUMCO . . . . . B17  
 1/8JJCO . . . . . C8  
 1/8JJN . . . . . C8  
 1/8JN . . . . . C7  
 1/8VAA Series . . . . . C12, C13  
 1/8VAACO . . . . . C13  
 1/8VAAN . . . . . C13  
 1/8VAANCO . . . . . C13  
 1/8VAU . . . . . B15  
 1/4-2J . . . . . C7  
 1/4J Series . . . . . C5, C6  
 1/4J . . . . . C5, C6  
 1/4JAC . . . . . C7  
 1/4JACN . . . . . C7  
 1/4JAUAH . . . . . B12, B13  
 1/4JBC . . . . . C7  
 1/4JBCJ . . . . . C7  
 1/4JCO . . . . . C7  
 1/4JF . . . . . C7  
 1/4JN . . . . . C7  
 1/4QMJ . . . . . C11  
 1/4QMJML . . . . . C11  
 1/4VMAU . . . . . B15  
 1/2-2J . . . . . C9  
 1/2J Series . . . . . C5, C9  
 1/2JBC . . . . . C9  
 1/2JBCJ . . . . . C9  
 1/2JCO . . . . . C9  
 1/2JN . . . . . C9  
 1J Series . . . . . C5, C10  
 1JN . . . . . C10  
 10535-1/4J . . . . . B15, B18

10536-1/2J . . . . . B15, B18  
 10537-1J . . . . . B15, B18  
 10880-1/4JAU . . . . . B16  
 11005-1/8J . . . . . C7  
 11005-1/4J . . . . . C7  
 11438 Air Line Filter . . . . . G9  
 11438 Pressure Regulators . . . . . G12  
 13242-1/4JAU . . . . . B16  
 14675-1/8JJAU . . . . . B17  
 14700-1/8JJAU . . . . . B17  
 15475 Split-Eyelet Connector . . . . . G19  
 16106 Liquid Strainer . . . . . G4  
 16860-1/8JJAU . . . . . B17  
 16883-1/8JJAU . . . . . B17  
 17180 Extension . . . . . G18  
 17185 Extension . . . . . G18  
 17366-1/4JAU . . . . . B16  
 17690-1/8JJAU . . . . . B17  
 18096 Extension . . . . . G18  
 19330-1/4JAUPM . . . . . B16

**2**

2202 Pipe Hanger . . . . . G22  
 20470 Spray Gun . . . . . C7  
 22140 Pressure Tank Assembly . . . . . G23  
 23220 Plug Valves . . . . . G17  
 2335-SE Spray Pipe Assembly . . . . . G21  
 23412 AirJet Fogger . . . . . E4, E6  
 26383 Liquid Pressure Gauge . . . . . G11  
 26385 Liquid Pressure Gauge . . . . . G11  
 28945-001-316SS . . . . . G21  
 28945-002-SS . . . . . G21  
 28945-003-316SS . . . . . G21  
 2-Way Solenoid Valve . . . . . G14

**3**

38180 Split-Eyelet Swivel Union . . . . . G19  
 38499-1/8JJAU . . . . . B17  
 39273 Level Switches . . . . . G24  
 39275 Level Switches . . . . . G24  
 3-Way Solenoid Valve . . . . . G14

**4**

45265 AirJet Fogger . . . . . E4, E5



45269 AirJet Fogger . . . . . E4, E5  
 46440 Block Manifold . . . . . F4, F5  
 49660-1/8JJAU . . . . . B17

**5**

50580 Adjustable Siphon Injectors . . . . . G25  
 53500 Modular Manifold . . . . . F4, F5  
 54000 Modular Manifold . . . . . F4, F5  
 54500 Modular Manifold . . . . . F4, F5

**6**

6123 Extension . . . . . G18  
 6083-1/4JAU . . . . . B16  
 6218-1/4JAU . . . . . B16  
 63600 Sanitary Manifold . . . . . F4, F6  
 6552-1/8JAC . . . . . C7

**7**

72070 Heated Air Atomizing Manifold . . . . . F4, F6  
 72100-1/8JJAU . . . . . B15, B18  
 7310-1/4JAU . . . . . B16

**8**

8370 Split-Eyelet Connector . . . . . G19  
 8650 . . . . . C7

**9**

98250 Manifold . . . . . F4, F6  
 9830 . . . . . G4

**PART NUMBER – ALPHABETICAL****A**

AA(B)343M-PP . . . . . G16  
 AA(B)344M-PP . . . . . G16  
 AA(B)346M-PP . . . . . G16  
 AA10000AUH-0050 . . . . . B7, B8  
 AA10000AUH-03 . . . . . B7  
 AA10000AUH-03-Z1 . . . . . B7  
 AA10000AUH-10 . . . . . B7, B8  
 AA10000AUH-104210 . . . . . B7, B8  
 AA10000AUH-104214 . . . . . B7, B8  
 AA10000AUH-104215 . . . . . B7, B8  
 AA10000AUH-72440-1/4 . . . . . B7, B8  
 AA10000JAU-10 . . . . . B10, B11  
 AA10000JJAU . . . . . B10, B11  
 AA122 . . . . . G4  
 AA124/AA430 . . . . . G5  
 AA22AUH . . . . . B12, B13  
 AA22AUH-7676 . . . . . B12, B13  
 AA22AUH-SS-11024 . . . . . B12, B14  
 AA22AUH-SS-14799 . . . . . B12, B14  
 AA24AUA . . . . . B12, B14  
 AA24AUA-20190 . . . . . B12, B14  
 AA24AUA-8395 . . . . . B12, B14  
 AA24AUA-8980 . . . . . B12, B14  
 AA250AUH . . . . . B9  
 AA26AUH . . . . . B9  
 AA26AUH-24200-2-1/2 . . . . . B9  
 AA28JJAU-49815 . . . . . B10, B11  
 AA29JAUCO . . . . . B10, B11

**C**

CP31158-002-SS Wall Mount Adapter . . . . . G22  
 CP31158-003-SS Wall Mount Adapters . . . . . G22

**D**

D55500-JAU . . . . . B15, B18

D55500-JAUCO . . . . . B15, B18  
 D55500-JAUH1 . . . . . B12, B13  
 D55500-JAUHO . . . . . B12, B13

**J**

JAUA . . . . . B15, B16  
 JAUACO . . . . . B16  
 JAUAD . . . . . B16  
 JAUADN . . . . . B16  
 JAUAMCO . . . . . B16  
 JAUAPM . . . . . B16  
 JAUAPMCO . . . . . B16

**Q**

QJ25655 AirJet Fogger . . . . . E4, E6  
 QuickMist® Series Nozzles . . . . . D50

**P**

PWMD Premium Hydraulic . . . . . D12  
 PWMM Premium Hydraulic . . . . . D12

**T**

TG Hydraulic Full Cone Tips . . . . . D17  
 TG-W Hydraulic Full Cone Tips . . . . . D17  
 TN Hydraulic Hollow Cone Tips . . . . . D18  
 TN-SSTC Hydraulic Hollow Cone Tips . . . . . D19  
 TP-TC Hydraulic flat Spray Tips . . . . . D13  
 TPU Hydraulic Flat Spray Tips . . . . . D6  
 TWD Liquid Strainer . . . . . G4  
 TX Hydraulic Hollow Cone Tips . . . . . D18

**V**

VAU/VMAU Variable Series . . . . . B15, B18  
 VX Variable Spray Series . . . . . B15, B18

**Y**

YMF MiniFogger® III . . . . . E4, E7













***Spraying Systems Co.***<sup>®</sup>  
Experts in Spray Technology

North Avenue and Schmale Road, P.O. Box 7900, Wheaton, IL 60187-7901 USA

Tel: 1.800.95.SPRAY    Intl. Tel: 1.630.665.5000

Fax: 1.888.95.SPRAY    Intl. Fax: 1.630.260.0842

Email: [info@spray.com](mailto:info@spray.com)

[www.spray.com](http://www.spray.com)



Catalog 76B AA-AUTO

© 2023 Spraying Systems Co. All rights reserved. Full protection of law claimed under Universal Copyright and Berne Conventions and other applicable national and international laws.